

OWNER'S/ OPERATOR'S MANUAL

PART NO.'s

831180

1800 Lb. Capacity
(with Sleeve)

831190

2200 Lb. Capacity
(with Sleeve)

832215

2200 Lb. Capacity
(with Cast Steel Socket)

832214

31.5" Spear
(with Cast Steel Socket)

CAUTION

For Safe Operation Read Rules
And Instructions Carefully

SINO LEEINGLES, PIDA AYUDA
A AIGUIEN QUE SI LO LEA
PARA QUE LE TRADUZCA LAS
MEDIDAS DE SEGURIDAD.

FORGED REPLACEMENT BALE SPEARS

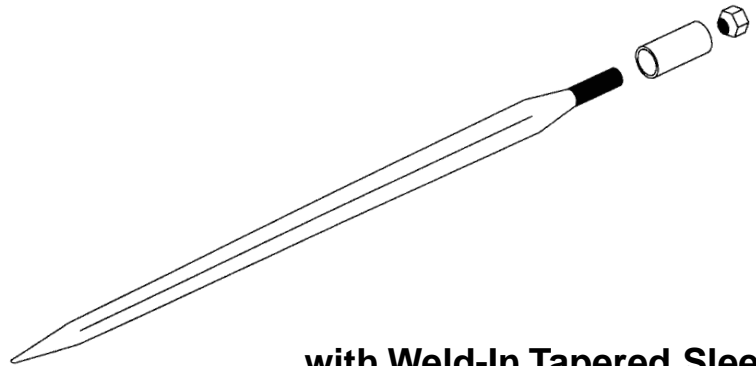

with Weld-In Tapered Sleeve

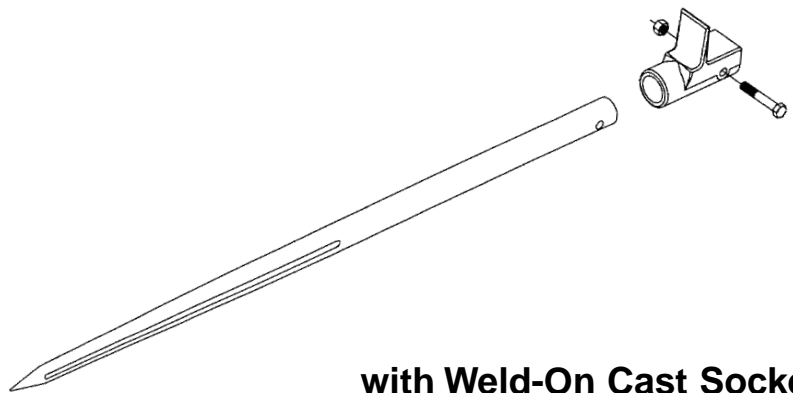

with Weld-On Cast Socket

Safety Instructions Tractor Preparation Operating Instructions

CAUTION

THE FOLLOWING SAFETY PRECAUTIONS SHOULD BE THOROUGHLY UNDERSTOOD BEFORE ATTEMPTING TO BEGIN ASSEMBLING THIS MACHINE

1. Select an area for assembly that is clean and free of any debris which might cause persons working on the assembly to trip.
2. Do not lift heavy parts or assemblies. Use crane, jack, tackle, fork trucks or other mechanical devices.
3. Preview the assembly instructions in your operator's manual before proceeding further.
4. If the assembly instructions call for parts or assemblies to be blocked up, use only blocking material that is in good condition and is capable of handling the weight of the assembly to be blocked. Also insure that the blocking material is on a clean, dry surface.
5. Never put hands, or any part of body, under blocked up assemblies if at all possible.
6. After completing assembly, thoroughly inspect the machine to be sure that all nuts, bolts, hydraulic fittings or any other fastened assemblies have been thoroughly tightened.
7. Before operating the machine, thoroughly read the operation section of your operator's manual.
8. Before operating, read the maintenance section of your operator's manual to be sure that any parts requiring lubrication, such as gearboxes, are full, to avoid any possible damage.
9. **Before operating equipment – If you have any questions regarding the proper assembly or operation, contact your dealer or representative.**

To the Owner/Operator/Dealer

All implements with moving parts are potentially hazardous. There is no substitute for a cautious, safe-minded operator who recognizes the potential hazards and follows reasonable safety practices. The manufacturer has designed this implement to be used with all its safety equipment properly attached to minimize the chance of accidents.

BEFORE YOU START!!

**Read the safety messages on the implement and shown in your manual.
Observe the rules of safety and common sense!**



THIS SYMBOL MEANS

- ATTENTION!**
- BECOME ALERT!**
- YOUR SAFETY IS INVOLVED!**

THIS SAFETY ALERT SYMBOL IDENTIFIES IMPORTANT SAFETY WARNING MESSAGES. CAREFULLY READ EACH WARNING MESSAGE THAT FOLLOWS. FAILURE TO UNDERSTAND AND OBEY A SAFETY WARNING, OR RECOGNIZE A SAFETY HAZARD, COULD RESULT IN AN INJURY OR DEATH TO YOU OR OTHERS AROUND YOU. THE OPERATOR IS ULTIMATELY RESPONSIBLE FOR THE SAFETY OF HIMSELF, AS WELL AS OTHERS, IN THE OPERATING AREA OF THE TRACTOR AND ATTACHED EQUIPMENT.

UNDERSTAND SIGNAL WORDS

Note the use of the signal words **DANGER**, **WARNING** and **CAUTION** with the safety messages. The appropriate signal word for each has been selected using the following guidelines:

DANGER: Indicates an imminently hazardous situation that, if not avoided, will result in death or serious injury. This signal word is to be limited to the most extreme situations typically for machine components which, for functional purposes, cannot be guarded.

WARNING: Indicates a potentially hazardous situation that, if not avoided, could result in death or serious injury, and includes hazards that are exposed when guards are removed. It may also be used to alert against unsafe practices.

CAUTION: Indicates a potentially hazardous situation that, if not avoided, may result in minor or moderate injury. It may also be used to alert against unsafe practices.

If you have questions not answered in this manual or require additional copies or the manual is damaged, please contact your dealer or the manufacturer directly.

IMPORTANT SAFETY INFORMATION!

Working with unfamiliar equipment can lead to careless injuries. Read this manual, and the manual for your tractor, before assembly or operating, to acquaint yourself with the machines. It is the implement owner's responsibility, if this machine is used by any person other than yourself, is loaned or rented, to make certain that the operator, prior to operating:

1. Reads and understands the operator's manuals.
2. Is instructed in safe and proper use.



The use of this equipment is subject to certain hazards which cannot be protected against by mechanical means or product design. All operators of this equipment must read and understand this entire manual, paying particular attention to safety and operating instructions, prior to using. If there is something in this manual you do not understand, ask your supervisor, or your dealer, to explain it to you.

SAFETY INSTRUCTIONS (continued)



EQUIPMENT SAFETY GUIDELINES



Never use alcoholic beverages or drugs which can hinder alertness or coordination while operating equipment. Consult your doctor about operating machinery while taking prescription medications.



Review the safety instructions with all users annually.



This equipment is dangerous to children and persons unfamiliar with its operation. The operator should be a responsible adult familiar with farm machinery and trained in this equipment's operations. **Do not allow persons to operate or assemble this unit until they have read this manual and have developed a thorough understanding of the safety precautions and of how it works.**



To prevent injury or death, use a tractor equipped with a Roll-Over Protective System (ROPS). Keep foldable ROPS systems in "locked up" position at all times. Keep seat belt fastened. Do not paint over, remove or deface any safety signs or warning signs on your equipment. Observe all safety signs and practice the instruction on them.



Never exceed the limits of a piece of machinery. If its ability to do a job, or to do so safely, is in question – **DON'T TRY IT.**



Do not modify the equipment in any way. Unauthorized modification may impair the function and/or safety and could affect the life of the equipment.



Safety hazard control and accident prevention are dependent upon the awareness, concern, prudence, and proper training of personnel involved in the operation, transport, maintenance, and storage of the machine. Refer also to Safety Messages and Operation Instructions in each of the appropriate sections of the Tractor and Implement Manuals. Pay close attention to the Safety Signs affixed to the Tractor and the Implement.



SAFETY SIGNS



Keep safety signs clean and legible at all times.



Replace safety signs that are missing or have become illegible.



Replaced parts that displayed a safety sign should also display the current sign.



Safety signs are available from your Distributor or Dealer Parts Department or the factory.

How to Install Safety Signs:







Be sure that the installation area is clean and dry.



Be sure temperature is above 50°F (10°C).







SAFETY INSTRUCTIONS (continued)

How to Install Safety Signs (continued):

-  Decide on the exact position before you remove the backing paper.
-  Remove the smallest portion of the split backing paper.
-  Align the sign over the specified area and carefully press the small portion with the exposed sticky backing in place.
-  Slowly peel back the remaining paper and carefully smooth the remaining portion of the sign in place.
-  Small air pockets can be pierced with a pin and smoothed out using the piece of sign backing paper.



SAFETY TRAINING

-  Safety is a primary concern in the design and manufacture of our products. Unfortunately, our efforts to provide safe equipment can be wiped out by a single careless act of an operator.
-  In addition to the design and configuration of equipment, hazard control and accident prevention are dependent upon the awareness, concern, prudence and proper training of personnel involved in the operation, transport, maintenance and storage of equipment.
-  It has been said, “The best safety device is an informed, careful operator.” We ask you to be that kind of an operator. It is the operator’s responsibility to read and understand ALL Safety and Operating instructions in the manual and to follow these. Accidents can be avoided.
-  Working with unfamiliar equipment can lead to careless injuries. Read this manual, and the manual for your tractor and loader or implement, before assembly or operating, to acquaint yourself with the machines. It is the equipment owner’s responsibility, if machinery is used by any person other than yourself, is loaned or rented, to make certain that the operator, prior to operating:
 1. Reads and understands the operator’s manuals.
 2. Is instructed in safe and proper use.
-  Know your controls and how to stop tractor, engine, and implement quickly in an emergency. Read this manual and the one provided with your tractor, loader and/or implement.
-  Train all new personnel and review instructions frequently with existing workers. A person who has not read and understood all operating and safety instructions is not qualified to operate the machine. An untrained operator exposes himself and bystanders to possible serious injury or death.
-  Do not allow children to operate machinery.

SAFETY INSTRUCTIONS (continued)



OPERATIONAL SAFETY



The use of this equipment is subject to certain hazards which cannot be protected against by mechanical means or product design. All operators of this equipment must read and understand this entire manual, paying particular attention to safety and operating instructions, prior to using. If there is something in this manual you do not understand, ask your supervisor, or your dealer, to explain it to you.



Personal protection equipment including hard hat, safety glasses, safety shoes, and gloves are recommended during assembly, installation, operation, adjustment, maintaining, repairing, removal, or moving the implement. Do not allow long hair, loose fitting clothing or jewelry to be around moving parts.



Never permit any person other than the operator to ride or board the tractor or implement at any time. **ALLOW NO RIDERS!**



The use of any loader attachment is NOT recommended on tractor with a tricycle wheel arrangement. Tricycle type tractors are unstable for front loader use.



A heavy load can cause instability in driving a tractor. Make sure the front or rear of the tractor is properly counter-balanced with weights. Always drive slowly – especially around turns. An unstable tractor could steer badly and possibly tip over, causing injury or death.



Most accidents occur because of neglect or carelessness. Keep all helpers and bystanders at a safe distance. **REMEMBER FALLING BALES CAN ROLL OR TUMBLE.**



Beware of low electrical wires when loader is raised. Serious injury or death can result if contact is made.



Always insert spears into the bale – NEVER under the bale. Failure to insert spears into bale can allow bale to roll back when loader is raised, causing serious injury or death.



Do not handle bales that exceed the bale weight limitations of the loader or bale spears.



Carry the bale slowly and as low as possible to the ground.



Operate the loader and hydraulic controls smoothly, avoiding jerky operation.



When handling round bales on a slope, always approach the bale with the tractor facing uphill.



Never use the tractor/loader to stop a rolling bale.



Only use a tractor equipped with a ROPS cab or rollover protective structure. Keep foldable ROPS systems in “locked up” position at all times. Keep seat belt fastened.



















When stacking bales, **ALWAYS MAKE SURE BALES ARE PLACED SO THE STACK IS STABLE.**

SAFETY INSTRUCTIONS (continued)



OPERATIONAL SAFETY (continued)

-  For operator safety, always keep bale in front of tractor hood. NEVER position bale back over operator. ALWAYS BE CAREFUL!
-  Always load rear of tractor first and unload last when using a front loader.
-  Beware of lift clearance when raising loader to maximum height.
-  Keep alert and watch the rear as well as the front when working with the loader.
-  When maneuvering close to buildings or passing through narrow areas, be sure to allow sufficient clearance for the tractor, loader, and bale. Drive slowly.
-  Operate loader from operator's seat only. Remain at controls until operating cycle is complete.
-  Stop loader gradually when lowering or lifting loads.
-  Allow for additional length of loader and bale on tractor while turning.
-  Never allow anyone to walk or work under a raised loader.
-  Be sure that people, livestock, or pets are not standing near the machine while operating.
-  Do not use loader for a work platform.
-  Do not lift or carry anyone on loader or in bucket or on attachment.
-  ALWAYS lower loader to the ground or block securely before performing any maintenance work.
-  Stay alert for holes, rocks and roots in the terrain and other hidden hazards. Keep away from drop-offs.
-  Use extreme care and maintain minimum ground speed when transporting on hillside, over rough ground and when operating close to ditches or fences. Be careful when turning sharp corners.
-  Reduce speed on slopes and sharp turns to minimize tipping or loss of control. Be careful when changing directions on slopes. Do not start or stop suddenly on slopes. Avoid operation on steep slopes.

SAFETY INSTRUCTIONS (continued)



OPERATIONAL SAFETY (continued)



When using a unit, a minimum 20% of tractor and equipment weight must be on tractor front wheels. Without this weight, tractor could tip over, causing personal injury or death. The weight may be attained with a front end loader, front wheel weights, ballast in tires of front tractor weights. When attaining a minimum 20% of tractor and equipment weight on the front wheels, you must not exceed the ROPS weight certification. Weigh the tractor and equipment. Do not guess or estimate!



Avoid excessive speed during operation.



ALWAYS lower spear points to the ground when parking tractor. Raised spear points could cause injury to people or livestock.



Always shut off tractor and shift to "Park" or set brakes when leaving tractor. Always lower bucket or attachment to ground. Remove key when leaving tractor unattended.



Before operating equipment: if you have any questions regarding the proper assembly or operation, contact your dealer or representative.



TRANSPORT SAFETY



Comply with state and local laws governing highway safety and movement of farm machinery on public roads.



The use of flashing amber lights is acceptable in most localities. However, some localities prohibit their use. Local laws should be checked for all highway lighting and marking requirements.



When driving the tractor and equipment on the road or highway under 20 mph (32 kph) at night or during the day, use flashing amber warning lights and a slow moving vehicle (SMV) identification emblem.



Always be sure the implement is in the proper raised position for transport.



Reduce speed when transporting mounted implements to avoid bouncing and momentary loss of steering control.



Make sure large round bales transported on tractor rear 3 pt. hitch do not obstruct visibility of tractor's flashing lights or SMV sign.



When transporting large round bales, keep load as low as practical to maximize tractor stability.



Transporting large round bales on front loaders can limit visibility. Keep load low and go slow if visibility is obstructed. Always use extra care.



Turn curves or go up or down hills only at a low speed and at a gradual steering angle. Make certain that at least 20% of the tractor's weight is on the front wheels to maintain safe steering. Slow down on rough or uneven surfaces, and loose gravel.



Use extreme care and maintain minimum ground speed when transporting on hillside, over rough ground and when operating close to ditches or fences. Be careful when turning sharp corners.





Never allow riders on either tractor or implement. Falling off can kill.

SAFETY INSTRUCTIONS (continued)





MAINTENANCE SAFETY

-  Keep all persons away from operator control area while performing adjustments, service, or maintenance.

-  Make sure there is plenty of ventilation. Never operate the engine of the towing vehicle in a closed building. The exhaust fumes may cause asphyxiation.

-  Before working on machine, drive to a level area, disengage the PTO, lower implement (or if working underneath, raise and block securely), shut off the engine, set the brakes, and remove the ignition keys.

-  Never work under equipment unless it is blocked securely. Never depend on hydraulic system to keep implement in raised position.

-  Always use personal protection devices such as eye, hand and hearing protectors, when performing any service or maintenance.

-  Periodically tighten all bolts, nuts and screws and check that all cotter pins are properly installed to ensure unit is in a safe condition.

-  When completing a maintenance or service function, make sure all safety shields and devices are installed before placing unit in service.

-  Never use your hands to locate a hydraulic leak on attachments. Use a small piece of cardboard or wood. Hydraulic fluid escaping under pressure can penetrate the skin.

-  Openings in the skin and minor cuts are susceptible to infection from hydraulic fluid. If injured by escaping hydraulic fluid, see a doctor at once. Gangrene and death can result. Without immediate medical treatment, serious infection and reactions can occur.

-  Check to ensure all safety signs are installed and in good condition.

-  Never replace hex bolts with less than grade five bolts unless otherwise specified, i.e. shear bolts. Refer to bolt torque chart for head identification marking.

SAFETY INSTRUCTIONS (continued)



STORAGE SAFETY



Following operation or when unhooking, stop the tractor, set the brakes, disengage the PTO, shut off the engine and remove the ignition keys.



Store the unit in an area away from human activity. Do not permit children to play on or around the stored unit.



Do not park equipment where it will be exposed to livestock for long periods of time. Damage and livestock injury could result.



Make sure all parked machines are on a hard, level surface and engage all safety devices.



If blocking is used, make sure it is solid and secure before leaving area.

**ALWAYS OBEY ALL SAFETY RULES!
ALWAYS BE CAREFUL!**

SAFETY SIGNS

WARNING

- **Read and follow owner's manual before installing, operating, or performing maintenance on this attachment. Observe safety recommendations in manual.**
- **Do not exceed weight limit of attachment or tractor.**
- **Do not lift or carry anyone on attachment.**
- **Attachment should be used with the proper weight package on front of tractor or with a loader installed. When handling loads on both ends of tractor, load rear first and unload last.**
- **Set wheels wide for increased stability.**
- **Never raise load to extreme heights on steep inclines.**
- **When handling large round bale, keep load as low as practical to maximize tractor stability.**
- **Make sure large round bale transported on tractor rear three point hitch attachment does not obstruct visibility of tractor's flashing lights or SMV sign.**
- **Do not stand or work under raised attachment.**
- **Stop engine, lower arms, relieve all hydraulic pressure, and lock brakes before leaving operator's seat.**
- **Failure to observe the above precautions can result in serious injury or death.**

101277

WARNING

Always insert spears in bale – never under bale.
Failure to do this can allow bale roll back when loader is raised, causing serious injury or death.

101127

**Install Safety Signs
(Decals) on your
equipment to remind
all operators of
these basic
Safety Instructions.**

**Replace
Safety Decals
if damaged
or missing.**

INSTRUCTIONS

INTRODUCTION

The forged bale spear and sleeve are sold as replacement parts to repair spear type 3 pt. and front loader attachments.

Make sure you have the correct spear needed for the weight and size of bales to be handled.

Single forged bale spear attachments need stabilizer spikes to keep the bale from rotating when the main spear is not exactly in the center of the large round bale.

If the stabilizer spikes are damaged or missing, repair or replace them.

Some bale handling attachments have two or more forged main spears. Having two or more main spears provides stability and the need for the stabilizer spikes is eliminated.

Part #831180 is for up to 1800 lb. bales. This kit has a weld-in sleeve which requires a hole in the tubing frame.

Part #831190 is for up to 2200 lb. bales. This kit has a weld-in sleeve which requires a hole in the tubing frame.

On spear numbers 831180 and 831190, the threads and nut are metric – be sure correct tools are used.

Part #832215 is for up to 2200 lb. bales. This spear uses a 1/2" X 3" bolt to secure it to the cast steel spear socket. The cast steel socket can be welded to square or rectangular tubing. No hole in the tube is required which may make it easier to use than the spears requiring a tapered socket.

Part #832214 is for units handling mid-size rectangular bales. The spear useable length of 25". These spears are usually used in arrangements of 3 or 4 in a row with a spacing of 20 to 30 inches.

These spears also use a 1/2" X 3" bolt to secure it to the cast socket.

When using two of part number 831180 (1800 lb. rated capacity), spears use a total rated capacity of 3000 lb. when handling bales.

When using two of part number 831190 (2200 lb. rated capacity), spears use a total capacity of 4000 lb. when handling bales.

The reason for the lower total capacities of two spears is that the bale may not be positioned so that equal weight is on each spear. Therefore, one spear could be subjected to a heavier part of the bale load.

TRACTOR AND LOADER REQUIREMENTS AND PREPARATION



It is recommended that tractors be equipped with a roll-over protective structure (ROPS) or cab.



The use of any loader attachment is NOT recommended on tractors with a tricycle wheel arrangement. Tricycle type tractors are unstable for front loader use.

The required size of the tractor and front loader will be determined by the size and weight of the bales to be handled.

Remember, high moisture hay (silage) bales are very heavy in relation to similar size dry hay bales.

Always use a tractor and front loader large enough to safely handle your bales.

Check your tractor and front loader to make sure they are in good working condition. Check all frame mounting bolts to make sure they are tight.

Loaders that attach to the tractor frame rails should have a cross-tie installed for stability.

Check the hydraulic system. Be sure the tractor hydraulic oil and filter have been serviced according to the tractor manufacturer's recommendations.



Be sure your tractor is in good condition. Read all the safety precautions and make sure all tractor operators are familiar with the safety rules of operation.



A heavy load can cause instability in driving a tractor. Make sure the front or rear of the tractor is properly counter-balanced with weights. Always drive slowly – especially around turns. An unstable tractor could steer badly and possibly tip over, causing injury or death.

INSTRUCTIONS (continued)

WELD-IN SLEEVE INSTRUCTIONS

The weld-in repair sleeve included with the forged bale spear has an outside diameter of 2.0 inches and a length of 4.34 inches.

When installing the weld-in sleeve in a piece of tubing, it is recommended that the hole for the sleeve is close to the diameter of the sleeve (2.031"-2.062") so there is good supporting steel for the weld. If the tube hole is badly damaged or quite oversized, it is recommended that you consider replacing the tube member on that portion of the frame.

Make sure the sleeve is facing the correct direction and that the sleeve is properly aligned so the spear will be in the correct position for handling the bales.

NOTE: Check for and remove any weld splatter that might have accumulated on the inside of the weld-in sleeve during the welding process.

It is recommended that the weld-in sleeve be "tack welded" into position and then the frame moved so the person welding has easy access to the weld area. Inexperienced welding operators should not attempt "down hill" or "out-of-position welds" when welding this part. The weight of the bale will be on this welded part and a good quality weld is required.

WELD-ON STEEL CASTING INSTRUCTIONS

The weld-on steel casting for bolt-in spears can be welded on any square or rectangular steel tubing where the flat side of the tube is at least 3.0 inches. DO NOT use tubing with a wall thickness of less than 3/16"

The steel casting can be positioned on the top of the tube or turned 180° and welded on the bottom of the tube.

If you have an application where you have a vertical tube, the casting is NOT recommended. (The casting is not designed for full side loads.) If you need to mount a spear in a vertical tube, it is recommended that you use a spear with a weld-in socket.

Make sure the casting is facing the correct direction and that the casting is properly aligned so the spear will be in the correct position for handling the bales.

NOTE: Check for and remove any weld splatter that might have accumulated on the inside of the weld-on casting during the welding process.

It is recommended that the weld-on casting be "tack welded" into position and then the frame moved so the person welding has easy access to the weld area.

Inexperienced welding operators should not attempt "down hill" or "out-of-position welds" when welding this part. The weight of the bale will be on this welded part and a good quality weld is required.

OPERATION

Be sure tractor is properly counterbalanced with weights before attempting to lift any load with the Bale Spear attachment.

If you are handling bales with both the front end loader and the 3 pt. hitch on the tractor, always load the 3 pt. attachment first and unload last.



Do not exceed the maximum recommended large round bale weight listed for each of the loader spear models. Damage to the equipment or serious personal injury could result.



On double spear types of front loader attachments, always insert spears into the bale – NEVER under the bale. Failure to insert spears into bale can allow bale to roll back when loader is raised, causing serious injury or death.



Never exceed the lift capacity of the tractor-loader used with the spear attachment.

Using the bucket tilt cylinders, adjust the angle of the spear(s) so they are parallel with the center of the hay bale.

With the tractor, push the spear(s) into the large hay bale. Make sure you have penetrated the hay bale far enough so the bale doesn't want to come off the end of the spear(s). If, when you initially pick the bale up, it tends to droop forward, this would indicate you have not penetrated the bale far enough.

Tilt the ends of the spear(s) upward (about 15-20 degrees) when transporting the hay bales. This will reduce any tendency for the bale to slide off the spear(s) while being transported.

INSTRUCTIONS (continued)

OPERATION (continued)

When you have placed the hay bale in the desired location, it is recommended to tilt the spear ends slightly downward (5-7 degrees) so as you pull away from the bale it will slide off the spear(s) more easily. Different location and circumstances will determine the best withdraw angle to use.

NOTE: Always make sure bale spear fully penetrates the bale. Partial penetration locates all the weight of the bale on the outer end and can damage spear. Not covered under warranty.

NOTE: In cold weather, a bale frozen to the ground may exceed the lifting capacity of spear and loader. Damage to spear or loader may occur. Not covered under warranty.

NOTE: Soft center bales will tend to droop after being lifted by a single spear. Placing the spear in a lower position in the bale will allow for more lifting height and lessen the load on the stabilizer spears.



Beware of low electrical wires when loader is raised. Serious injury or death can result if contact is made.

Keep all bystanders at a safe distance. REMEMBER – FALLING BALES CAN ROLL OR TUMBLE.

When stacking bales, ALWAYS MAKE SURE BALES ARE PLACED SO THE STACK IS STABLE.



NEVER LET ANYONE CLIMB ON STACKED ROUND HAY BALES!



For operator safety, always keep bales in front of tractor hood. NEVER position bale back over operator. ALWAYS BE CAREFUL!

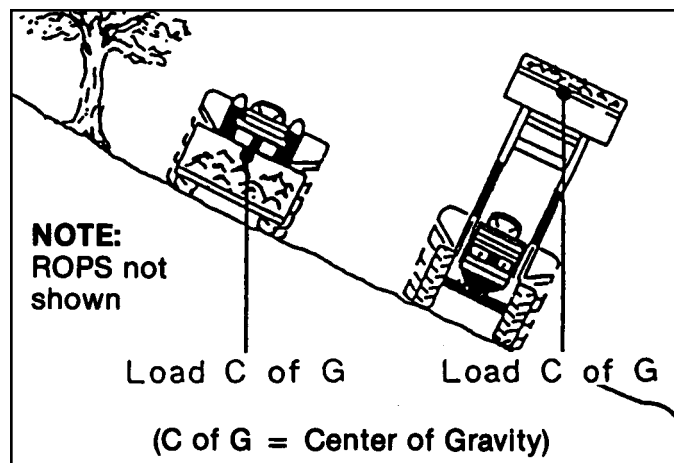

When working on side hills, **DO NOT RAISE LOADER TOO HIGH.** Keep an eye on terrain changes. Keep load low.

HANDLE ROUND BALES SAFELY

Improper use of loaders to handle round bales can result in serious injury or death to the tractor/loader operator. This could be caused by the bale rolling back down the loader into the operator's station.

For optimum stability and visibility:

- do not handle bales that exceed the bale weight limitations of the loader.
- carry the bale slowly and as low as possible to the ground.
- operate the loader controls smoothly, avoiding jerky operation.
- when handling round bales on a slope, always approach the bale with the tractor facing uphill.
- never use the tractor/loader to stop a rolling bale.
- only use a tractor equipped with a ROPS cab or roll-over protective structure.

MAINTENANCE

Check the pins at the ends of the loader arms. Make sure they are locked in place with the linchpins.

Periodically check all bolts to make sure they are tight. Lubricate loader as per instructions in loader manual.

Replace safety signs and instruction decals if damaged or missing.

#831180

1800 LB. FORGED SPEAR PACKAGE

PARTS LIST

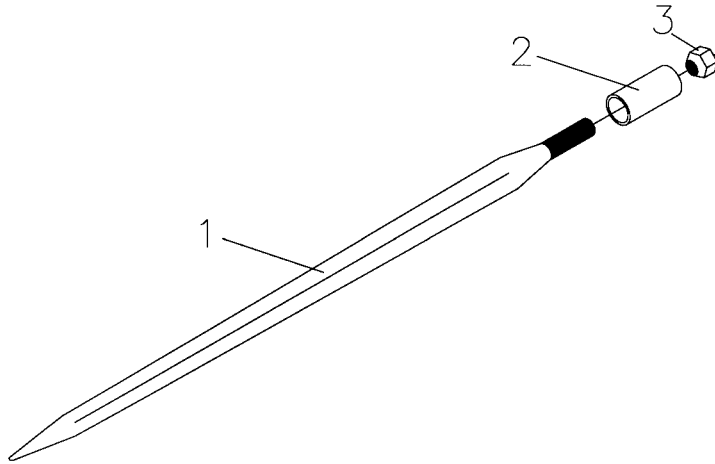

Ref. No.	Part No.	Description	No. Req'd.
1	831290	Forged Hay Tine	1
2	831292	Sleeve, Hay Tine	1
3	831291	Special Tine Nut	1
N/S	101127	Safety Sign – Warning (Always Insert Spears)	1

#831190

2200 LB. FORGED SPEAR PACKAGE

PARTS LIST

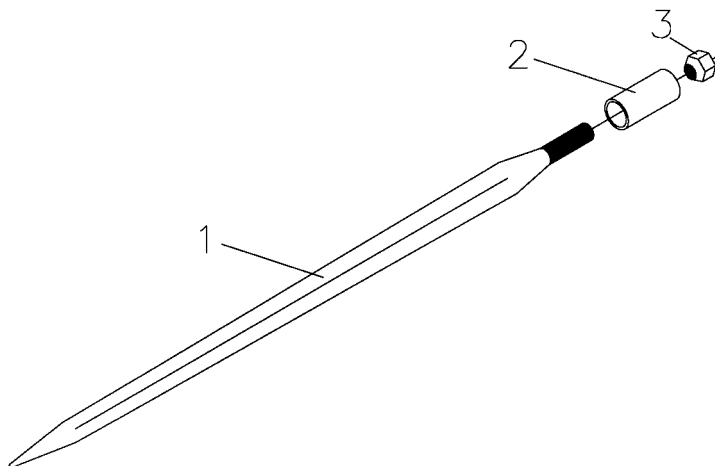

Ref. No.	Part No.	Description	No. Req'd.
1	831273	Forged Hay Tine	1
2	831292	Sleeve, Hay Tine	1
3	831274	Special Tine Nut	1
N/S	101127	Safety Sign – Warning (Always Insert Spears)	1

#832215

2200 LB. FORGED SPEAR PACKAGE

(SPEAR KIT w/CAST SOCKET - 47 1/4")

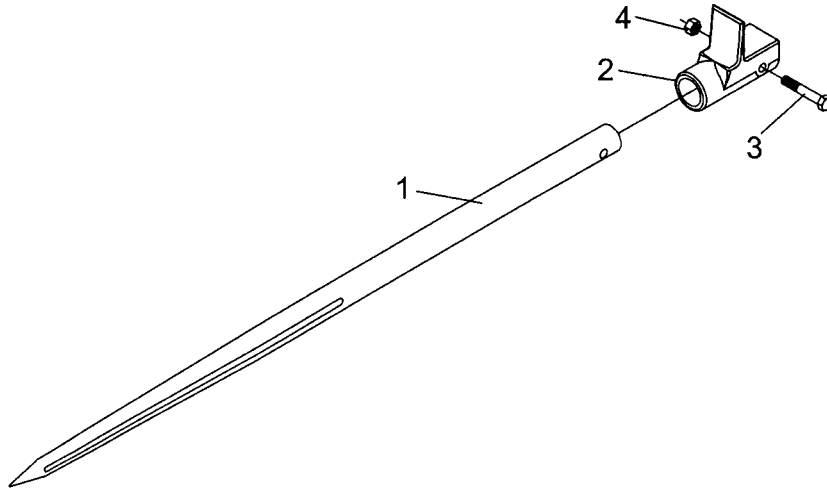

Ref. No.	Part No.	Description	No. Req'd.
1	830928	Spear, Bolt-In Forged (47 1/4")	1
2	832210	Socket Casting	1
3	2503012	Bolt 1/2"-13NC x 3" Hex Head Gr. 2	1
4	2500054	Nut 1/2"-13NC Stamplock Hex	1
N/S	101127	Safety Sign - Warning (Always Insert Spears)	1

#832214

FORGED SPEAR PACKAGE

(SPEAR KIT w/CAST SOCKET - 31 1/2")

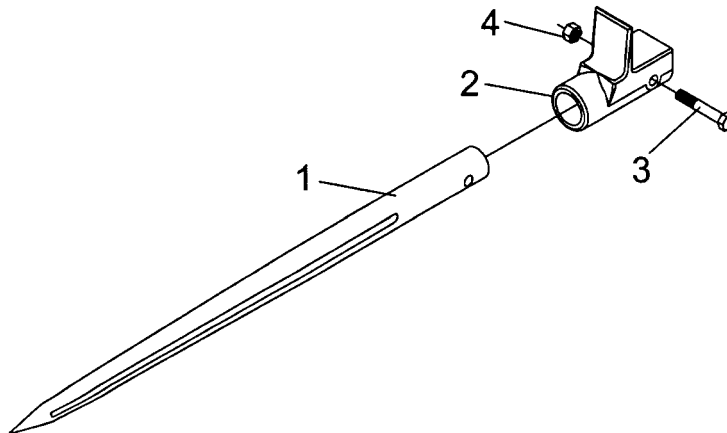

Ref. No.	Part No.	Description	No. Req'd.
1	830924	Spear, Bolt-In Forged (31 1/2")	1
2	832210	Socket Casting	1
3	2503012	Bolt 1/2"-13NC x 3" Hex Head Gr. 2	1
4	2500054	Nut 1/2"-13NC Stamplock Hex	1
N/S	101127	Safety Sign - Warning (Always Insert Spears)	1

⚠ SAFETY PRECAUTIONS ⚠

**MOST ACCIDENTS OCCUR BECAUSE OF NEGLIGENCE OR CARELESSNESS.
AVOID NEEDLESS ACCIDENTS BY FOLLOWING ALL OF THE SAFETY PRECAUTIONS LISTED BELOW.**

- Machinery should be operated only by those who are responsible and are authorized to do so.
- Stop the engine, lower all equipment, lock the brakes, and remove the ignition key before dismounting from the tractor.
- Never stand between tractor and implement while tractor is being backed to hitch.
- Loose fitting clothing should not be worn, to avoid catching on various parts.
- Detach implement in area where children normally do not play.
- When performing adjustments or maintenance on an implement, first lower it to the ground or block it securely at a workable height.
- Only a qualified operator should be permitted on tractor when in operation; no riders allowed.
- Make certain everyone is in the clear before starting tractor or raising or lowering equipment.
- Operate the tractor and implement only while seated in the driver's seat.
- Reduce speed when transporting mounted implements to avoid bouncing and momentary loss of steering control.
- A heavy load can cause instability of the tractor. Use extreme care during road travel. Slow down on turns and watch out for bumps. Tractor may need front counterweights to counter-balance the weight of the implement.
- Reduce speed on hillsides or curves so there is no danger of tipping.
- Avoid driving too close to the edge of ditches or creeks.
- Do not transport implement on public roads without reflectors and slow moving vehicle emblem in daylight and with approved warning lights at night and other periods of poor visibility.
- Due to the width of some implements, use extra caution on highways, farm roads, and when approaching gates.
- Always be sure the implement is in the proper position for transport.
- Keep alert and watch the front as well as the rear when working with the implement.

OWNER'S/ OPERATOR'S MANUAL

PART NO.'s

831180

831190

832215

832214

**WHEN ORDERING REPAIR
PARTS, ALWAYS GIVE THE
FOLLOWING INFORMATION:**

1. PART NUMBER
2. PART DESCRIPTION

SEPTEMBER 2007

- ✓ Keep children away from danger all day, every day.
- ✓ Equip tractors with roll-over protection (ROPS) and keep all machinery guards in place.
- ✓ Please work, drive, play, and live each day with care and concern for your safety and that of your family and fellow citizens.

LIMITED WARRANTY

Farm Star warrants its replacement parts to be free from defects in materials and workmanship for a period of 30 days from date of purchase. Upon written approval, Farm Star will repair or exchange without charge any part, which upon examination by Farm Star or its authorized agent, shall disclose to be defective.

This does not apply to (1) parts that have worn out in normal use, (2) parts broken because of improper assembly or operation by the customer, (3) parts accidentally damaged, (4) failure of parts traceable to improper care, (5) parts failing through use of implement for purposes other than those for which it was designed.

The obligations assumed by Farm Star and the limitations expressed herein are in lieu of all other warranties expressed or implied.

Farm Star cannot assume any responsibility for the use of these spears when used to modify existing attachments or when the owner uses them on equipment of his own design.