

OWNER'S/ OPERATOR'S MANUAL

MODEL NO.'s

CTMG-48S

CTMG-48JD

CAUTION

For Safe Operation
Read Rules And
Instructions Carefully

SI NO LEEINGLES, PIDA AYUDA
A AIGUIEN QUE SI LO LEA
PARA QUE LE TRADUZCA LAS
MEDIDAS DE SEGURIDAD.



CTMG-48S

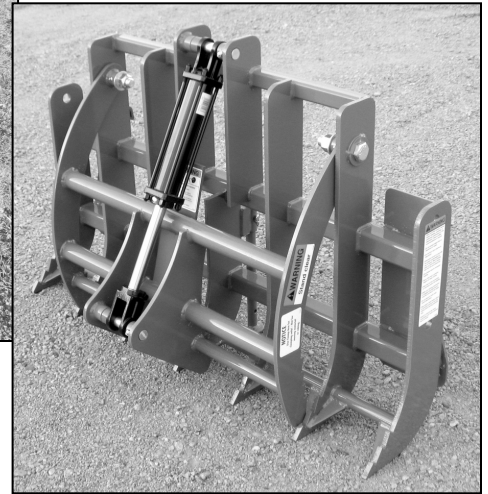

CTMG-48JD

Mini Grapple Rake for Compact Tractor and Sub-Compact Tractor Front Loaders

Safety Instructions
Tractor Preparation
Operating Instructions

Assembly & Mounting
Maintenance
Repair Parts

CAUTION

**THE FOLLOWING SAFETY PRECAUTIONS SHOULD BE THOROUGHLY UNDERSTOOD
BEFORE ATTEMPTING TO BEGIN ASSEMBLING THIS MACHINE**

1. Select an area for assembly that is clean and free of any debris which might cause persons working on the assembly to trip.
2. Do not lift heavy parts or assemblies. Use crane, jack, tackle, fork trucks or other mechanical devices.
3. Preview the assembly instructions in your operator's manual before proceeding further.
4. If the assembly instructions call for parts or assemblies to be blocked up, use only blocking material that is in good condition and is capable of handling the weight of the assembly to be blocked. Also insure that the blocking material is on a clean, dry surface.
5. Never put hands, or any part of body, under blocked up assemblies if at all possible.
6. After completing assembly, thoroughly inspect the machine to be sure that all nuts, bolts, hydraulic fittings or any other fastened assemblies have been thoroughly tightened.
7. Before operating the machine, thoroughly read the operation section of your operator's manual.
8. Before operating, read the maintenance section of your operator's manual to be sure that any parts requiring lubrication, such as gearboxes, are full, to avoid any possible damage.
9. **Before operating equipment – If you have any questions regarding the proper assembly or operation, contact your dealer or representative.**

TABLE OF CONTENTS

WARRANTY	2
SAFETY INFORMATION	3 - 10
SAFETY SIGNS	11
PREPARATION INSTRUCTIONS	12
SKID STEER TYPE MOUNTING	13
JOHN DEER MOUNTING	14
OPERATING INSTRUCTIONS	15 - 16
OWNER MAINTENANCE	17
TROUBLE-SHOOTING GUIDE	18-19
PARTS LISTS	20

SI NO LEEINGLES, PIDA AYUDA A AIGUIEN QUE SI LO LEA PARA QUE LE TRADUZCA LAS MEDIDAS DE SEGURIDAD.

STATEMENT OF POLICY

It is the policy of Worksaver, Inc. to improve its products where it is possible and practical to do so. Worksaver, Inc. reserves the right to make changes or improvements in design and construction at any time, without incurring the obligation to make these changes on previously manufactured units.

TO THE OWNER:

Read this manual before using your Grapple Rake. This manual is provided to give you the necessary operating and maintenance instructions for keeping your Grapple Rake in top operating condition. Please read this manual thoroughly. Understand what each control is for and how to use it. Observe all safety signs on the machine and noted throughout the manual for safe operation of implement. Keep this manual handy for ready reference.

Like all mechanical products, it will require cleaning and upkeep.

Use only genuine Worksaver, Inc. service parts. Substitute parts will void the warranty and may not meet standards required for safe and satisfactory operation. Record the model and serial number of your Grapple Rake here:

Model: _____ Serial Number: _____

RETAIL CUSTOMER'S RESPONSIBILITY

It is the Retail Customer and/or Operator's responsibility to read the Operator's Manual, to operate, lubricate, maintain, and store the product in accordance with all instructions and safety procedures. Failure of the operator to read the Operator's Manual is a misuse of this equipment.

It is the Retail Customer and/or Operator's responsibility to inspect the product and to have any part(s) repaired or replaced when continued operation would cause damage or excessive wear to other parts or cause a safety hazard.

It is the Retail Customer's responsibility to deliver the product to the authorized Worksaver Dealer, from whom he purchased it, for service or replacement of defective parts which are covered by warranty. Repairs to be submitted for warranty consideration must be made within forty-five (45) days of failure.

It is the Retail Customer's responsibility for any cost incurred by the Dealer for traveling to or hauling of the product for the purpose of performing a warranty obligation or inspection.

LIMITED WARRANTY

Worksaver warrants to the original purchaser of any new Mini Grapple Rake (Models CTMG-48S and CTMG-48JD), that the equipment be free from defects in material and workmanship for a period of twelve (12) months for non-commercial, state, and municipalities. Use sixty (60) days for commercial use from date of retail sale.

NOTICE! Installing the Compact Tractor Model Mini Grapple Rakes on tractors with over 35 hp (engine) or on skid steer power units voids all warranty.

Replacement or repair parts installed in the equipment covered by this warranty are warranted for sixty (60) days from the date of purchase of such part or to the expiration of the applicable new equipment warranty period, whichever occurs later.

Such parts shall be provided at no cost to the user during regular working hours. Worksaver reserves the right to inspect any equipment or parts which are claimed to have been defective in material or workmanship.

DISCLAIMER OF IMPLIED WARRANTIES & CONSEQUENTIAL DAMAGES

Worksaver's obligation under this warranty, to the extent allowed by law, is in lieu of all warranties, implied or expressed, including implied warranties of merchantability and fitness for a particular purpose and any liability for incidental and consequential damages with respect to the sale or use of the items warranted. Such incidental and consequential damages shall include but not be limited to: transportation charges other than normal freight charges; cost of installation other than cost approved by Worksaver; duty; taxes; charges for normal service or adjustments; loss of crops or any other loss of income; rental of substitute equipment, expenses due to loss, damage, detention or delay in the delivery of equipment or parts resulting from acts beyond the control of Worksaver.

THIS WARRANTY SHALL NOT APPLY:

1. To vendor items which carry their own warranties, such as hydraulic cylinders, tires, and tubes.
2. If the unit has been subjected to misapplication, abuse, misuse, negligence, fire or other accident.
3. If parts not made or supplied by Worksaver have been used in connection with the unit, if, in sole judgement of Worksaver such use affects its performance, stability, or reliability.
4. If the unit has been altered or repaired outside of an authorized Worksaver dealership in a manner which, in the sole judgement of Worksaver affects its performance, stability or reliability.
5. To normal maintenance service and normal replacement items such as gearbox lubricant, hydraulic fluid, worn blades, or to normal deterioration of such things as belts and exterior finish, due to use or exposure.
6. To expendable or wear items such as teeth, chains, sprockets, belts, springs and other items that in the company's sole judgement is a wear item.

NO EMPLOYEE OR REPRESENTATIVE OF WORKSAVER IS AUTHORIZED TO CHANGE THIS WARRANTY IN ANY WAY OR GRANT ANY OTHER WARRANTY UNLESS SUCH CHANGE IS MADE IN WRITING AND SIGNED BY WORKSAVER'S SERVICE MANAGER, POST OFFICE BOX 100, LITCHFIELD, ILLINOIS 62056-0100.

To the Owner/Operator/Dealer

All implements with moving parts are potentially hazardous. There is no substitute for a cautious, safe-minded operator who recognizes the potential hazards and follows reasonable safety practices. The manufacturer has designed this implement to be used with all its safety equipment properly attached to minimize the chance of accidents.

BEFORE YOU START!!

Read the safety messages on the implement and shown in your manual.
Observe the rules of safety and common sense!



THIS SYMBOL MEANS

- ATTENTION!
- BECOME ALERT!
- YOUR SAFETY IS INVOLVED!

THIS SAFETY ALERT SYMBOL IDENTIFIES IMPORTANT SAFETY WARNING MESSAGES. CAREFULLY READ EACH WARNING MESSAGE THAT FOLLOWS. FAILURE TO UNDERSTAND AND OBEY A SAFETY WARNING, OR RECOGNIZE A SAFETY HAZARD, COULD RESULT IN AN INJURY OR DEATH TO YOU OR OTHERS AROUND YOU. THE OPERATOR IS ULTIMATELY RESPONSIBLE FOR THE SAFETY OF HIMSELF, AS WELL AS OTHERS, IN THE OPERATING AREA OF THE TRACTOR AND ATTACHED EQUIPMENT.

UNDERSTAND SIGNAL WORDS

 **DANGER** Indicates an imminently hazardous situation that, if not avoided, WILL result in DEATH OR VERY SERIOUS INJURY.

 **WARNING** Indicates a imminently hazardous situation that, if not avoided, COULD result in DEATH OR SERIOUS INJURY.

 **CAUTION** Indicates a imminently hazardous situation that, if not avoided, MAY result in MINOR INJURY.

IMPORTANT Identifies special instructions or procedures that, if not strictly observed, could result in damage to, or destruction of the machine, attachments or the environment.

NOTE: *Identifies points of particular interest for more efficient and convenient operation or repair.*

If you have questions not answered in this manual or require additional copies or the manual is damaged, please contact your dealer or the manufacturer directly.

IMPORTANT SAFETY INFORMATION!

Working with equipment can lead to injuries. Read this manual, and the manual for your tractor, before assembly or operating, to acquaint yourself with the machines. It is the implement owner's responsibility, if this machine is used by any person other than yourself, is loaned or rented, to make certain that the operator, prior to operating:

1. Reads and understands the operator's manuals.
2. Is instructed in safe and proper use.

 The use of this equipment is subject to certain hazards which cannot be protected against by mechanical means or product design. All operators of this equipment must read and understand this entire manual, paying particular attention to safety and operating instructions, prior to using. If there is something in this manual you do not understand, ask your supervisor, or your dealer, to explain it to you.

SAFETY INSTRUCTIONS (continued)



EQUIPMENT SAFETY GUIDELINES

Safety of the operator is one of the main concerns in designing and developing a new piece of equipment. Designers and manufacturers build in as many safety features as possible. However, every year many accidents occur which could have been avoided by a few seconds of thought and a more careful approach to handling equipment. You, the operator, can avoid many accidents by observing the following precautions in this section. To avoid personal injury, study the following precautions and insist those working with you, or for you, follow them.

In order to provide a better view, certain photographs or illustrations in this manual may show an assembly with a safety shield removed. However, equipment should never be operated in this condition. Keep all shields in place. If shield removal becomes necessary for repairs, replace the shield prior to use.



Replace any CAUTION, WARNING, DANGER or instruction safety sign that is not readable or is missing. Do not paint over, remove or deface any safety signs or warning signs on your equipment. Observe all safety signs and practice the instruction on them. Review the safety instructions with all users annually.



This equipment is dangerous to children and persons unfamiliar with its operation. The operator should be a responsible adult familiar with farm machinery and trained in this equipment's operations. **Do not allow persons to operate or assemble this unit until they have read this manual and have developed a thorough understanding of the safety precautions and of how it works.**



To prevent injury or death, use a tractor equipped with a Roll-Over Protective System (ROPS). Keep foldable ROPS systems in "locked up" position at all times.



Never use alcoholic beverages or drugs which can hinder alertness or coordination while operating this equipment. Consult your doctor about operating this machine while taking prescription or over the counter medications.



Personal protection equipment including hard hat, safety glasses, safety shoes, and gloves are recommended during assembly, installation, operation, adjustment, maintaining, repairing, removal, or moving the implement. Do not allow long hair, loose fitting clothing or jewelry to be around moving parts.



Never exceed the limits of a piece of machinery. If its ability to do a job, or to do so safely, is in question – **DON'T TRY IT.**



Do not modify the equipment in any way. Unauthorized modification may impair the function and/or safety and could affect the life of the equipment.















In addition to the design and configuration of this implement, including Safety Signs and Safety Equipment, hazard control and accident prevention are dependent upon the awareness, concern, prudence, and proper training of personnel involved in the operation, transport, maintenance, and storage of the machine. Refer also to Safety Messages and Operation Instructions in each of the appropriate sections of the Tractor and Implement Manuals. Pay close attention to the Safety Signs affixed to the Tractor and the Implement.

SAFETY INSTRUCTIONS (continued)



OPERATIONAL SAFETY

-  Start tractor only when properly seated in the tractor seat. Starting a tractor in gear can result in injury or death. Do not mount or dismount the tractor while the tractor is moving. Mount or dismount the tractor only when the tractor and all moving parts are completely stopped.
-  Operate the tractor and/or implement controls only while properly seated in the tractor seat with the seat belt securely fastened around you. Inadvertent movement of the tractor or implement may cause serious injury or death.
-  Keep all helpers and bystanders twenty-five feet (25') from an operating power unit and attached equipment. Only properly trained people should operate this machine. It is recommended the tractor be equipped with a Rollover Protection System (ROPS) and a seat belt that is used. Always stop the tractor, skid steer, or forklift, set brake, shut off the engine, remove the ignition key, and lower loader and attachment to the ground before dismounting. Never leave equipment unattended with the engine running.
-  Please remember it is important that you read and heed the safety signs on the front loader attachment and loader, and the safety rules set forth. Clean or replace all safety signs if they cannot be clearly read and understood. They are there for your safety as well as the safety of others. The safe use of this machine is strictly up to you, the operator.
-  Be sure power unit is in good condition. Read all the safety precautions and make sure all operators are familiar with the safety rules of operation.
-  Never leave the tractor and implement unattended while the implement is in the lifted position. Accidental operation of lifting lever or a hydraulic failure may cause sudden drop of unit with injury or death by crushing.
-  When the use of hand tools is required to perform any part of assembly, installation, adjustment, maintaining, repairing, removal, or moving the implement, be sure the tools used are designed and recommended by the tool manufacturer for that specific task.
-  Never allow children to play on or around tractor or implement. Children can slip or fall off the equipment and be injured or killed. Inadvertent contact with controls can cause the implement to shift or fall crushing themselves or others.
-  Always use two people to handle heavy, unwieldy components during assembly, installation, removal, or moving the loader attachment.
-  Never place any part of your body where it would be in danger if movement should occur during assembly, installation, operation, maintaining, repairing, removal, or moving the implement.
-  Be certain the power unit is in neutral or park position before starting engine.
-  A heavy load can cause instability in driving a power unit. Make sure the front or rear of the power unit is properly counter-balanced with weights. Always drive slowly – especially around turns. An unstable power unit could steer badly and possibly tip over, causing injury or death.

SAFETY INSTRUCTIONS (continued)



OPERATIONAL SAFETY (continued)



Check that this attachment is securely mounted to the loader. Failure to install lock pins or have the latching mechanism engage could result in injury or death.



Do not allow children or others to ride on the power unit with an operator. Riders are subject to injury such as being struck by foreign objects or being thrown off. Riders obstruct the operator's view resulting in unsafe operation. **Never allow anyone to ride on the implement!**



Operate the loader controls smoothly, avoiding jerky operation. Stop loader gradually when lowering or lifting loads.



Beware of low electrical wires when loader is raised. Serious injury or death can result if contact is made.



When handling material on a slope, always approach the material with the power unit facing uphill.



Only use a power unit equipped with a ROPS cab or rollover protective structure. Keep foldable ROPS systems in "locked up" position at all times. Keep seat belt fastened.



When stacking logs or stumps, ALWAYS MAKE SURE MATERIAL IS PLACED SO THE STACK IS STABLE.



Keep all bystanders at a safe distance. REMEMBER FALLING LOGS OR STUMPS CAN ROLL OR TUMBLE.



Do not handle loads that exceed the weight limitations of the loader.



Carry the loads slowly and as low as possible to the ground. Avoid excessive speed during operation.



For operator safety, always keep load in front of power unit. NEVER position load back over operator. ALWAYS BE CAREFUL!



Always shut off power unit and shift to "Park" or set brakes when leaving unit. Always lower bucket or attachment to ground, relieve all hydraulic pressure. Remove key when leaving equipment unattended. Park in level area.

















Keep alert and watch the rear as well as the front when working with the loader.

SAFETY INSTRUCTIONS (continued)

















OPERATIONAL SAFETY (continued)

-  When maneuvering close to buildings or passing through narrow areas, be sure to allow sufficient clearance for the power unit, loader, and load. Drive slowly. Allow for additional length of loader and load on power unit while turning.
-  Operate loader from operator's seat only. Remain at controls until operating cycle is complete.
-  Use extreme care when working on inclines and hillsides. Do not operate close to ditches, creeks or holes. Slow down when operating over rough ground.
-  Before you operate any equipment, check over all pins, bolts and connections to be sure all are securely in place. Replace any damaged or worn parts immediately.
-  Do not work under a raised loader unless it is securely blocked or held in position. Do not depend on the power unit hydraulic system to hold the implement in place.
-  Keep load centered on Grapple Rake and loader. Unbalanced loads increase possibility of tipping or roll-over.
-  When handling brush or branches, be aware of branches that might contact power unit or operator.
-  When cleaning up old building sites, check for live utility lines. Always be sure electric, gas, and water lines have been properly disconnected.
-  Check material to be handled, especially at old building sites or dumps. Be alert for any hazardous material that could be released by Grapple Rake contact. If in doubt, check with professional waste haulers.
-  Do not lift or carry anyone on loader or in bucket or on attachment.
-  ALWAYS lower loader to the ground or block securely before performing any maintenance work.
-  Always keep power unit on solid footing when operating loader.
-  Observe Safety Recommendations in loader instruction manual.
-  Inspect the entire machine periodically as indicated in the Maintenance Section of this manual. Look for loose fasteners, worn or broken parts, pinched hydraulic hoses, and leaky or loose fittings. Make sure all pins have cotter pins and washers. Serious injury may occur from not maintaining this machine in good working order.

SAFETY INSTRUCTIONS (continued)



TRANSPORT SAFETY

-  Comply with state and local laws governing highway safety and movement of farm machinery on public roads.
-  The use of flashing amber lights is acceptable in most localities. However, some localities prohibit their use. Local laws should be checked for all highway lighting and marking requirements.
-  When driving the tractor and equipment on the road or highway under 20 mph (32 kph) at night or during the day, use flashing amber warning lights and a slow moving vehicle (SMV) identification emblem.
-  Always be sure the implement is in the proper raised position for transport.
-  Reduce speed when transporting mounted implements to avoid bouncing and momentary loss of steering control.
-  Be aware of the operating conditions. Do not operate the tractor with weak or faulty brakes. When operating down a hill or on wet or rain slick roads, the braking distance increases; use extreme care and reduce your speed in these conditions. When operating in traffic, always use the tractor's flashing warning lights and reduce your speed. Be aware of traffic around you and watch out for the other guy.
-  Do not drink and drive!
-  Watch for traffic when operating near or crossing roadways. Plan your route to avoid heavy traffic.
-  Turn curves or go up or down hills only at a low speed and at a gradual steering angle. Make certain that at least 20% of the tractor's weight is on the front wheels to maintain safe steering. Slow down on rough or uneven surfaces, and loose gravel.
-  Use extreme care and maintain minimum ground speed when transporting on hillside, over rough ground and when operating close to ditches or fences. Be careful when turning sharp corners.
-  Never allow riders on either power unit or implement. Falling off can kill.
-  Be a safe and courteous driver. Always yield to oncoming traffic in all situations, including narrow bridges, intersections, etc.
-  Do not exceed 20 mph (32 kph). Reduce speed on rough roads and surfaces.
-  Always disengage PTO before driving the tractor to transport the implement from one place to another.

SAFETY INSTRUCTIONS (continued)





MAINTENANCE SAFETY

Good maintenance is your responsibility. Poor maintenance is an invitation to trouble.

-  Before working on this machine, drive to a level area, disengage the PTO, lower implement or loader (or if working underneath, raise and block securely), shut off the engine, relieve all hydraulic pressure, set the brakes, and remove the ignition keys.

-  Never work under equipment unless it is blocked securely. Never depend on hydraulic system to keep implement in raised position.

-  Do not use blocking made of concrete blocks, logs, buckets, barrels or any other material that could suddenly collapse or shift positions. Use only good quality blocking material.

-  Never operate controls from the ground. Operate the controls only from the operator's station.

-  Keep all persons away from operator control area while performing adjustments, service, or maintenance.

-  Always use personal protection devices such as eye, hand and hearing protectors, when performing any service or maintenance.

-  Periodically tighten all bolts, nuts and screws and check that all cotter pins are properly installed to ensure unit is in a safe condition.

-  When completing a maintenance or service function, make sure all safety shields and devices are installed before placing unit in service.

-  Never use your hands to locate a hydraulic leak on attachments. Use a small piece of cardboard or wood. Hydraulic fluid escaping under pressure can penetrate the skin.

-  Openings in the skin and minor cuts are susceptible to infection from hydraulic fluid. If injured by escaping hydraulic fluid, see a doctor at once. Gangrene and death can result. Without immediate medical treatment, serious infection and reactions can occur.

SAFETY INSTRUCTIONS (continued)



STORAGE SAFETY



Following operation, or when unhooking, stop the tractor, set the brakes, disengage the PTO, shut off the engine and remove the ignition keys.



Use extreme care to keep feet and hands from under the unit and clear of any pinch points. Never stand or allow another person to stand between a running tractor and the unit when disconnecting the implement from the tractor.



Do not park equipment where it will be exposed to livestock for long periods of time. Damage and livestock injury could result.



Store the unit in an area away from human activity. Do not permit children to play on or around the stored unit.



Make sure all parked machines are on a hard, level surface and engage all safety devices. Storage location should be level and solid to make connecting and unconnecting to power unit easy.



SAFETY SIGNS

Keep safety signs clean and legible at all times.

Replace safety signs that are missing or have become illegible.

Replaced parts that displayed a safety sign should also display the current sign.

Safety signs are available from your Distributor or Dealer Parts Department or the factory.

How to Install Safety Signs:

Be sure that the installation area is clean and dry. Be sure temperature is above 50°F (10°C).

Decide on the exact position before you remove the backing paper.

Remove the smallest portion of the split backing paper. Align the sign over the specified area and carefully press the small portion with the exposed sticky backing in place.

Slowly peel back the remaining paper and carefully smooth the remaining portion of the sign in place. Small air pockets can be pierced with a pin and smoothed out using the piece of sign backing paper.

SAFETY SIGNS

BE CAREFUL!

Use a clean, damp cloth to clean safety decals. Avoid spraying to close to decals when using a pressure washer; high-pressure water can enter through very small scratches or under edges of decals causing them to peel or come off.

WARNING

- Keep load centered on Grapple Rake and loader. Unbalanced loads increase possibility of tipping or roll-over.
- When handling brush or branches, be aware of branches that might contact power unit or operator.
- When cleaning up old building sites, check for live utility lines. Always be sure electric, gas, and water lines have been properly disconnected.
- Check material to be handled, especially at old building sites or dumps. Be alert for any hazardous material that could be released by grapple rake contact. If in doubt, check with professional waste haulers.
- When stacking logs, trees, or stumps always make sure the load will not roll back toward the power unit when released from grapple rake.
- Failure to observe the above warnings could result in serious injury or death.

101129

WARNING

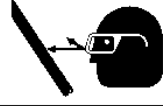
HIGH-PRESSURE FLUID HAZARD

To prevent serious injury or death:

- Relieve pressure on system before repairing or adjusting or disconnecting.
- Wear proper hand and eye protection when searching for leaks. Use wood or cardboard instead of hands.
- Keep all components in good repair.

SW700

WARNING



To avoid injury or death caused by falling attachment:

- Quick lock pins must be installed at all times.

101296

Above Safety Sign ONLY for Models CTMG-48JD

WARNING

- Read and follow owner's manual before installing, operating, or performing maintenance on this loader. Observe safety recommendations in manual.
- Do not exceed weight limit of loader or tractor.
- Do not lift or carry anyone on loader or in bucket or attachment.
- For operator safety, always keep load in front of tractor hood. NEVER position load back over operator.
- Add recommended wheel ballast or rear weight for stability. When handling loads on both ends of tractor, load rear first and unload last.
- Set wheels wide for increased stability.
- Never raise loader to extreme heights on steep inclines.
- Do not stand or work under raised loader.
- Stop engine, lower arms, relieve all hydraulic pressure, and lock brakes before leaving operator's seat.
- When handling round bales with fork type equipment, be sure bolt-in stabilizer spike is installed. Without spike, uncontrolled bale movement could occur.
- Failure to observe the above precautions can result in serious injury or death.

101026

REMEMBER:

If Safety Signs have been damaged, removed, become illegible or parts replaced without Signs, new Safety Signs must be applied. New Safety Signs are available from your authorized distributor or factory.

WARNING

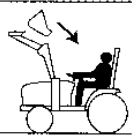

To avoid injury or death caused by falling attachment:
Lockpins must completely engage attachment plate slots.

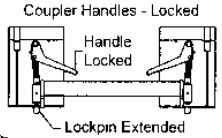

101313

For Model CTMG-48S only



INSTRUCTIONS

TRACTOR AND FRONT LOADER REQUIREMENTS AND PREPARATION

The Mini Compact Tractor Grapple Rake is designed to handle logs, brush, loose stumps, limbs, medium size rocks, and other hard to handle materials.

A 2" bore x 8" stroke hydraulic cylinder operates the grapple clamp to grip and hold the material.

The Mini Compact Tractor Grapple Rake is available in two models. The models CTMG-48S and CTMG-48JD are designed to mount on tractor front-end loaders only.

NOTE: The model CTMG-48S is designed for tractor loaders having the "universal skid steer bucket quick-attach" mount.

NOTE: The model CTMG-48JD is designed for tractor loaders with the John Deere Attach interface to mount to H120, H130, D160, D165, 200C and 200 CX loaders.

NOTICE! The model CTMG-48S is NOT designed for use on skid steer power units.

One pair of remote hydraulic coupler outlets are required to operate the grapple clamp cylinder.

The models CTMG-48S and CTMG-48JD Compact Tractor Grapple Rakes are recommended for tractors with a engine horsepower rating of 20-35 hp.

All loaders need to have sufficient lift capacity to handle the expected load and the weight of the Mini Grapple Rake.

WARNING

Power unit must be equipped with ROPS or ROPS cab and seat belt. Keep seat belt securely fastened. Falling off power unit can result in death from being run over or crushed. Keep foldable ROPS systems in "locked up" position at all times.

CAUTION

Be sure your tractor and loader are in good condition. Read all the safety precautions and make sure all equipment operators are familiar with the safety rules of operation.

Check the power unit's hydraulic system. Be sure the hydraulic oil and filter have been serviced according to manufacturer's recommendations. Refer to your tractor or loader operator's manual or dealer for any adjustments necessary to put the hydraulic system in good working order.

The operator is responsible for the safe operation of this equipment. The operator must be properly trained. Operators should be familiar with the tractor, loader and loader attachment, and all safety practices before starting operation. Read the safety rules and safety signs on pages 3-11.

WARNING

A heavy load can cause instability in driving a power unit. Make sure the rear of the tractor is properly counterbalanced with weights. Always drive slowly – especially around turns. An unstable power unit could steer badly and possibly tip over, causing injury or death.

A parking stand is included on both models.

ASSEMBLY

This unit is shipped completely assembled (less hoses).

Refer to the "exploded views" on pages 20-24 of this manual.

Remove the bucket from your front end loader. Check your loader to make sure it is in good working order.

The model CTMG-48S will mount on tractor loaders with the universal bucket quick-attach mount (see page 13).

The model CTMG-48JD will mount on tractor loaders with the John Deere quick-attach system (see page 14).

It is recommended that you purchase and install two 90° hydraulic fittings in the 2" x 8" hydraulic cylinder. The cylinder has ¾" – 16 ORB (SAE 8). These are for O-Ring style fittings that do not require thread sealant.

Because the length of hose required to go from the attachment to the location of the power units remote hydraulic outlets can vary greatly, the hoses are not supplied.

Route the hoses back to your tractor/loader control valve. Be sure to allow a loop of hose just behind the attachment to allow for the tilt angles that will be encountered. Make sure that the hoses are routed so they will not be pinched or snagged by attachment pivot arms, loader, or tractor parts. Fasten the hoses securely so they will remain in the correct position and not drop down where they could be pinched or sheared.

After making the hose connection between the tractor remote outlets and the grapple cylinder, operate the grapple clamp several times to work the air out of the system.

INSTRUCTIONS (continued)

MODEL CTMG-48S ATTACHMENT TO PRIME MOVER



WARNING

Improper attachment of the Grapple Rake could result in injury or death. Do not operate this product until you have positive indication that the attachment is securely mounted.

1. Position the attachment on a level surface.
2. The quick attach coupler handles should be in the unlocked position with lock pins retracted, Figure 2.

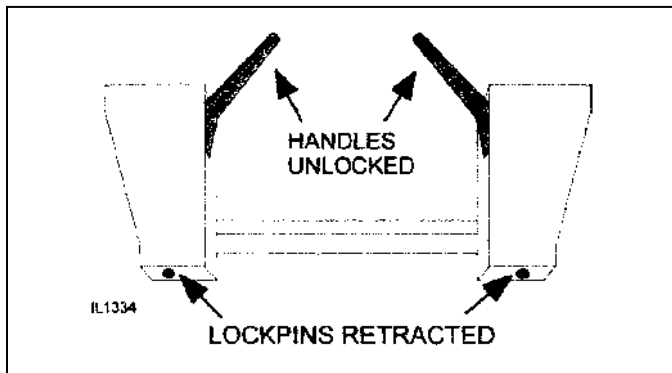

Figure 2. Quick Attach Coupler Handles - Unlocked

3. Enter the prime mover. Fasten seatbelt, start engine. Disengage the parking brake.
4. Follow the attaching procedure in the prime mover owner's manual. Align the attachment mechanism with the mounting on the grapple rake, attach to the prime mover on loader.
5. Engage the parking brake and shut down the prime mover. Be sure to relieve pressure to the auxiliary hydraulic lines.
6. Unfasten safety restraints and exit the prime mover.
7. Engage the latching mechanism to secure attachment to loader. The lockpins must be completely extended and secured into the retaining slots.
8. Re-enter the prime mover. Fasten seatbelt and re-start engine.

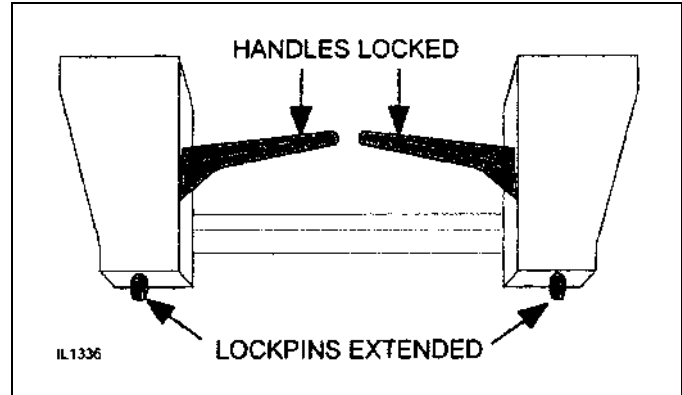

Figure 3. Attachment Coupler Handles - Locked



WARNING

Attachment coupler handles must always be rotated to LOCK POSITION to prevent coupler latch from disengaging and attachment from falling off.

9. Carefully raise the loader and cycle the rollback/tilt cylinders to check clearances and to ensure that the attachment is securely mounted.

REMOVING THE GRAPPLE RAKE

1. If possible, find a level solid location to place the attachment. This makes it easier to disconnect and re-connect later on.
2. Lower the attachment to the ground.
3. Engage the parking brake and shut down the prime mover. Be sure to relieve pressure to the auxiliary hydraulic lines.
4. Unfasten safety restraints and exit prime mover.
5. Disengage attachment-locking mechanism (mechanical type). Lower the parking stand and pin to secure.
6. Enter prime mover, fasten safety restraints and start the prime mover.
7. Disengage attachment-locking mechanism (hydraulic type).
8. Disengage the parking brake, and back away from the attachment.

INSTRUCTIONS (continued)

MODEL CTMG-48JD ATTACHMENT TO PRIME MOVER

The model CTMG-48JD specifically designed for John Deere 400 and 500 series loaders.

NOTE: Procedure is the same for all attachments. Bucket attachment shown.

ATTACHING

1. Extend bucket tilt cylinders to angle attaching brackets forward.

NOTE: Angle must be greater than that of the brackets on the rear of the grapple rake.

2. Drive forward, adjusting loader height and position until the top of the loader bracket engages the hooks (C) on the grapple rake.
3. Slowly retract the bucket tilt cylinders and raise the loader so the lower lock pins (F) engage the hole in the holder strap (E).
4. Continue to retract the tilt cylinders and raise the loader until the main frame of the grapple rake is vertical.
5. Engage tractor parking brake and/or place transmission in PARK. Shut off tractor engine and remove key.
6. Install the quick-lock-pin (A) into the pins (F) on each side of the grapple rake. Raise the parking stand and pin in place.

Installation is now complete.

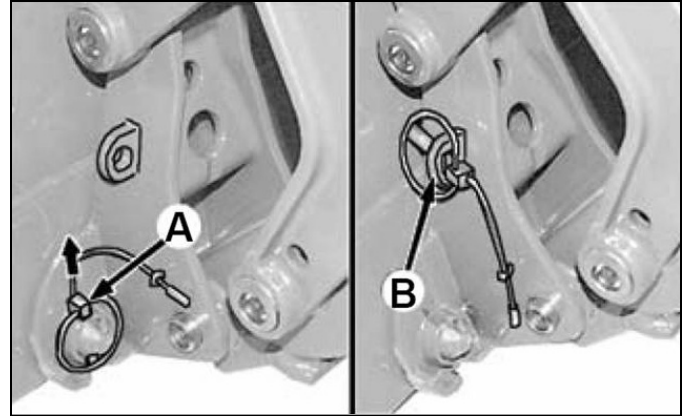
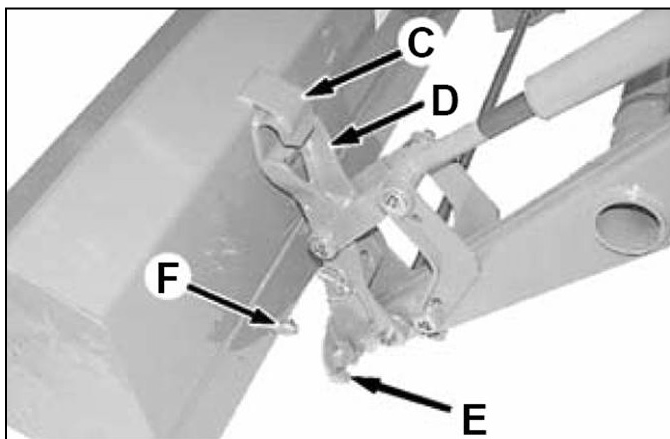

NOTE: On attachments with two pins (F), the 200, 300 and 400 series loaders will utilize the upper pin and the 500 series loader will utilize the lower pin.

CAUTION!



ALWAYS CHECK LATCH PINS BEFORE TILTING OR OPERATING ANY ATTACHMENT.

DETACHING

1. Engage tractor parking brake and/or place transmission in PARK. Shut off tractor engine and remove key.
2. Remove the quick lock-pin (A) from each side of attachment. Store pins in storage position (B). Lower and pin the parking stand.
3. Start engine and lower the grapple rake to the ground. Extend bucket tilt cylinders until pin (F) releases from holder strap (E) on each side of attachment. Lower the loader until holder brackets are free from the hooks. Back tractor away from attachment.
4. Set parking brake and/or place transmission in PARK. Shut off engine and remove key.

**REPLACE
SAFETY SIGNS
IF DAMAGED
OR MISSING!**

OPERATING INSTRUCTIONS

PRE-OPERATION CHECKLIST

(OWNER/OPERATOR RESPONSIBILITY)

- ___ Review and follow safety rules and safety signs on pages 3 through 11.
- ___ Check that Grapple Rake is properly and securely attached to tractor loader or skid steer.
- ___ Lubricate all grease fitting locations.
- ___ Check that all hardware is properly installed.
- ___ Check that no one enters the area of machine operation. Always work at a safe distance from roads, built-up areas, or populated places.
- ___ Know your controls and how to stop tractor, engine and PTO quickly in an emergency. **READ THIS MANUAL AND THE ONE PROVIDED WITH YOUR POWER UNIT.**
- ___ To avoid accident or injury, do not allow anyone to operate this equipment without proper instructions. Any person who operates this equipment must be instructed in and be capable of the safe operation of the tractor, skid steer, attachment and all controls.

OPERATION

Be sure tractor is properly counter-balanced with weights before attempting to lift any load with the Grapple Rake Attachment. It is recommended to attach a heavy implement or weight box on the 3 pt. hitch of the tractor for counter weight.

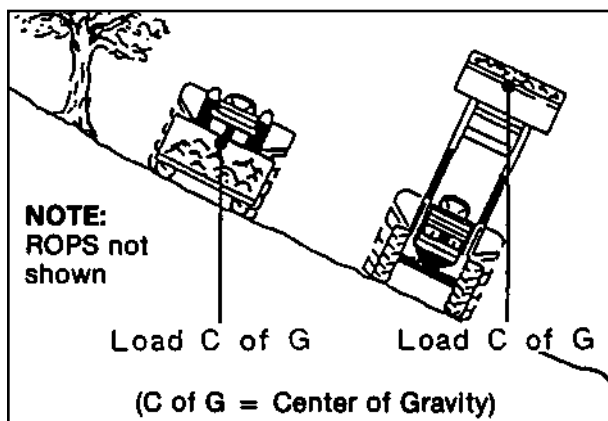

When working on side hills, **DO NOT RAISE LOADER TOO HIGH.** Keep an eye on terrain changes. Keep load low.

SAFETY INSTRUCTIONS

Observe all instruction and safety decals on the Grapple Rake. These safety signs are shown for reference. Read them carefully before using the Grapple Rake. Replace any decals that may be faded or damaged.

Make sure all operators have read the Owner's/Operator's Manual and are familiar with the instructions and the safety rules of operation.

OPERATE LOADER SAFELY

- Improper use of loader can cause serious injury or death.
- Become familiar with controls.
- Be sure anyone operating the loader is aware of safe operation and potential hazards. Read and observe safety recommendations in loader manual.
- Operate loader from operator's seat only. Remain at controls until operating cycle is complete.
- Stop loader gradually when lowering or lifting loads.
- Use particular care when working on inclines and hillsides.
- Avoid holes, ditches, and obstructions which may cause tractor/loader to tip.
- Allow for additional length of loader on tractor while turning.
- Never allow anyone to walk or work under a raised loader.
- Be sure that people, livestock, or pets are not standing near the machine while operating.
- Do not handle loads that exceed the weight limitations of the loader.
- Carry the loads slowly and as low as possible to the ground.
- Operate the loader hydraulic controls smoothly, avoiding jerky operation.
- When handling material on a slope, always approach the material with the tractor facing uphill.
- Only use a tractor or power unit equipped with a ROPS cab or roll-over protective structure.
- Travel slowly over rough ground or when making turns.
- Lower bucket or attachment to ground when loader is unattended.

OPERATING INSTRUCTIONS (continued)

HANDLING MATERIAL

Approach the material to be handled with the grapple clamp open, when the rake frame contacts the material, close the grapple clamp. As the load is lifted, tilt the frame back and then apply hydraulic pressure to the grapple clamp a second time. Sometimes, as the load is being lifted or pulled from a pile, it will shift.

It is recommended that the Grapple Rake be tilted back when transporting. Always carry a load in a low position so that you have good visibility and a low center of gravity.

When lifting a heavy log or tree, always lift slowly and while the load is low to the ground, make the decision if the grapple rake is properly positioned or if the load is too big or heavy to safely handle.

If necessary, the operator must release the Grapple Rake from the load and back away. Then use a chain saw to cut it into lighter or more manageable pieces.

When handling a pile of posts, trees, boards, limbs, etc., it may be necessary to release the load and pick up smaller amounts.

The Grapple Rake used properly, will make difficult handling and clean up jobs easier, but it requires a good safe operator.

When picking up logs or fallen trees, make sure that you pick up in the center of the load weight. Remember that the stump end of a tree that has been bulldozed out of the ground has a lot of soil attached to the roots and can be very heavy.

If you are handling stumps that have soil attached to the roots, it is strongly suggested that you use the rake points to loosen and knock the soil off. Picking the stumps up and dropping them a few times will also remove soil. Removing soil from the roots will result in a cleaner burn pile and less cleanup work later.

When approaching a pile of brush or trees, watch out for branches sticking out of pile that may contact operator or power unit.

If operator is handling large branches or trees that are considerably wider than the width of the power unit, always be alert for branches of standing trees that could snap back toward the operator.

NOTE: Grapple Rake Limitations

The Grapple Rake is designed for handling loose logs, trees, stumps, brush, or other loose material. **It is not designed for heavy bulldozing.**

The rake frame will dig into piles of trees and stumps to consolidate them into few piles for more complete

Grapple Rake Limitations (continued)

burning and final land clearing. The rake frame is not designed to bulldoze out stumps or buried rocks. DO NOT turn when tines are in ground.

NOTE: To prevent damage to the grapple clamp arm, DO NOT use the grapple clamp to push or lift trees, logs, or stumps. DO NOT use the grapple clamp arm to rake or pull material back.

The grapple clamp is designed for holding material against the rake main frame for handling only. It is NOT built for pushing, pulling, raking, or lifting heavy objects.



WARNING

Keep load centered on Grapple Rake and loader. Unbalanced loads increase possibility of tipping or roll-over.

When handling brush or branches, be aware of branches that might contact power unit or operator.

When cleaning up old building sites, check for live utility lines. Always be sure electric, gas, and water lines have been properly disconnected.

Check material to be handled, especially at old building sites or dumps. Be alert for any hazardous material that could be released by grapple rake contact. If in doubt, check with professional waste haulers.

When stacking logs, trees, or stumps, always make sure the load will not roll back toward the power unit when released from Grapple Rake.

Failure to observe the above warnings could result in serious injury or death.



CAUTION

Beware of lift clearance when raising loader to maximum height.

When stacking or loading vehicles, make sure you are operating in an area AWAY FROM OVERHEAD WIRES.



DANGER

Beware of low electrical wires when loader is raised. Serious injury or death can result if contact is made.

Do not leave the operator's seat if any part of the power unit, loader or attachment contacts electric lines.

OWNER SERVICE



WARNING

■ Do not operate this product until you have positive indication that this attachment is securely mounted to the loader. Failure to install lock pins or have the latching mechanism engaged could result in injury or death.

■ Power unit must be equipped with ROPS or ROPS cab and seat belt. Keep seat belt securely fastened. Falling off power unit can result in death from being run over or crushed. Keep foldable ROPS systems in “locked up” position at all times.

MAINTENANCE



WARNING

Always stop the tractor, set brake, shut off engine, remove key, and lower loader to ground before attempting to service. Never leave equipment unattended with engine running.



WARNING

Do not work under a raised loader unless it is securely blocked or held in position. Do not depend on the hydraulic system to hold loader and attachment in place.

Periodically check all bolts to make sure they are tight.

Check hydraulic hoses. Make sure they are not chafed or pinched. Replace any damaged hose.

Check hydraulic hoses and fittings for leaks. Repair any leaks immediately. Never use your hand to check for a hydraulic leak when system is under pressure.

Periodically lubricate the clamp arm pivot bushings.

Thoroughly clean the grease zerks before servicing. Dirt mixed with lubricant will rapidly wear parts and destroy bearings. Keep it clean.

At the end of the working season or when the Grapple Rake will not be used for a long period, it is good practice to clean off any dirt or grease that may have accumulated.

Replace any worn or damaged parts immediately. Do not use attachment with any damaged parts.

TRANSPORTING



CAUTION

When traveling on public roads, whether at night or during the day, use accessory light and devices for adequate warnings to operators of other vehicles. Comply with all federal, state and local laws.

Check visibility. If visibility is impaired, reduce speed or consider other means of transport.

Allow for additional length of loader on tractor while turning. Carry load low.

Select a safe ground travel speed when transporting from one area to another. When traveling on roadways, transport in such a way that faster moving vehicles may pass you safely.

When traveling over rough or hilly terrain or when making turns, slow down and use extra care.

Read all the safety warnings in the front of this manual and in the manual of tractor.

STORAGE

- Always store in a safe place away from children or livestock.
- Inspect the grapple rake for loose, damaged or worn parts and adjust or replace if needed.
- Storage location should be level and solid to make hitching and unhitching easy.
- Coat the exposed part of the hydraulic cylinder rod with grease for protection.
- Lower the parking stands on the back of the main frame and pin to secure. Be sure to raise the stand legs and pin in the raised position before using the grapple.
- You may also store the grapple rake with the clamps fully opened and then face down. This leaves the grapple in a stable position with the rods of the hydraulic cylinders retracted into the cylinders. See figure below.

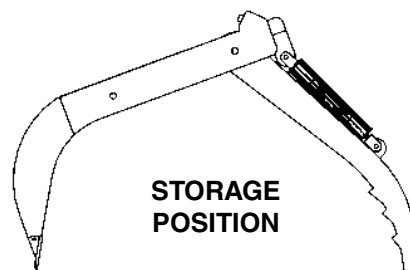

TROUBLE-SHOOTING GUIDE

PROBLEM	POSSIBLE CAUSE	POSSIBLE REMEDY
Grapple Rake clamp will not operate.	1. No or insufficient oil flow.	Remote hydraulic connection fittings not compatible. Check for proper fitting. Hydraulic system may not be supplying rated pressure. Consult your dealer. Hydraulic system may not be delivering its rated volume of oil due to wear. Hydraulic pump may need to be repaired. Hydraulic valve on tractor not engaged.
Grapple Rake is loose on loader.	1. Attachment not correct.	Grapple Rake mount may not be properly latched on tractor loader. Check lock pins.
Hydraulic hose failure.	1. Hydraulic relief pressure setting is very high and may cause hydraulic hose failure. 2. Hoses are worn or frayed. 3. Hose rating may be too low for hydraulic system pressure. 4. Hose is being pinched by movement of loader mount or loader linkage.	Check hydraulic system and adjust relief valve. Replace hose. Replace with higher rated hoses. Reroute hose and refasten.
Hydraulic oil overheats.	1. Hydraulic oil level in tractor may be low. 2. Hydraulic oil or oil filter in tractor may be dirty. 3. Hydraulic oil reservoir of tractor may be small.	Check and add oil. Change oil and filter according to power unit manufacturer's recommendations. Allow time for oil to cool down.
Tractor loader tilt cylinders won't pull back after tilting forward.	1. Loader too small for weight of material being handled. 2. Hydraulic system not operating at correct pressure.	Reduce amount of material handled. Check pressure and adjust or repair.

TROUBLE-SHOOTING GUIDE (continued)

PROBLEM	POSSIBLE CAUSE	POSSIBLE REMEDY
<p>Material slips from Grapple Rake grasp.</p>	<ol style="list-style-type: none"> 1. Clamp arms not positioned correctly on material. 2. Not firmly clamped by hydraulic cylinder. 3. Hydraulic system has leak – allowing clamping pressure to back off. 	<p>Reposition clamp arms.</p> <p>Operate hydraulic cylinder to clamp tighter.</p> <p>Find leak and repair (could be O-Ring in valve).</p>
<p>Excessive rear tractor tire slippage.</p>	<ol style="list-style-type: none"> 1. Tractor too small. 2. Insufficient traction. 	<p>Reduce amount handled.</p> <p>Add rear tire weights or add ballast in tire. Use tractor with FWDA.</p> <p>Attach heavy implement on rear of tractor for counter weight.</p>
<p>Bent lower main frame tines.</p>	<ol style="list-style-type: none"> 1. Improper operation. 	<p>Operator ramming into in-ground stumps or rocks – retrain operator.</p> <p>Operating in frozen ground – trying to loosen material too large to be handled.</p> <p>Turning while tines in ground.</p> <p>Mounted on too large of a tractor (over 35 hp).</p>

COMPACT TRACTOR FRONT LOADER GRAPPLE

Models CTMG-48JD & CTMG-48S Parts Drawing & List

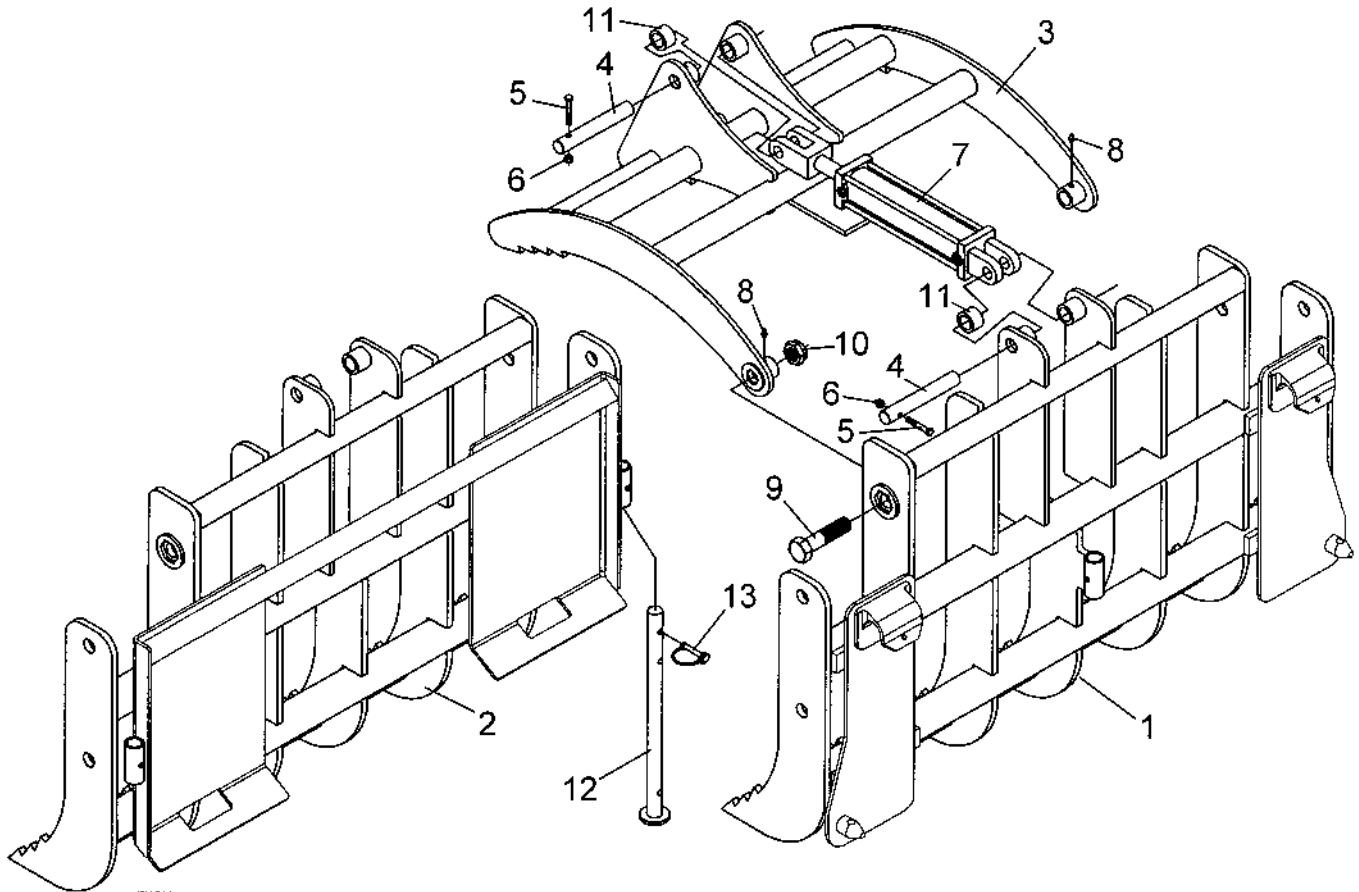

Ref. No.	Part No.	Description	No. Req'd.
1	811856	Mini-Grapple Main Frame (CTMG-48JD only)	1
2	811851	Mini-Grapple Main Frame (CTMG-48S only)	1
3	811735	Clamp Weldment	1
4	811744	Cylinder Pin	2
5	2503119	Bolt 5/16"-18NC x 2" Hex Head Gr. 5	2
6	2500046	Nut 5/16"-18NC Hex Nylock	2
7	2504230	Hydraulic Cylinder 2 x 8	1
8	2504049	Zerk, Drive 5/16"	2
9	2503309	Bolt 1"-8NC x 4" Hex Head Gr. 5	2
10	2500085	Nut 1"-8NC Hex Jam Nylock	2
11	814462	Spacer, Pin	2
12	343430	Stand Rod Weldment	Var.
13	590194	5/16" Lock Pin (AK-2907)	Var.
NS	101122	Safety Sign - Warning (Hi-Pressure)	1
NS	101288	Safety Sign - Warning (Crushing/Pinching)	1
NS	101289	Safety Sign - Warning (Avoid Injury)	1
NS	101295	Safety Sign - Warning (Crushing Hazard)	1

SAFETY REQUIREMENTS

AVOID ACCIDENTS BY FOLLOWING ALL OF THE SAFETY REQUIREMENTS LISTED BELOW.

- Machinery should be operated only by those who are responsible and are authorized to do so.
- Stop the engine, lower all equipment, lock the brakes, and remove the ignition key before dismounting from the tractor.
- Never stand between tractor and implement while tractor is being backed to hitch.
- Loose fitting clothing should not be worn, to avoid catching on various parts.
- Detach implement in area where children normally do not play.
- When performing adjustments or maintenance on an implement, first lower it to the ground or block it securely at a workable height.
- Only a qualified operator should be permitted on tractor when in operation; no riders allowed.
- Make certain everyone is in the clear before starting tractor or raising or lowering equipment.
- Operate the tractor and implement only while seated in the driver's seat.
- Reduce speed when transporting mounted implements to avoid bouncing and momentary loss of steering control.
- A heavy load can cause instability of the tractor. Use extreme care during road travel. Slow down on turns and watch out for bumps. Tractor may need front counterweights to counter-balance the weight of the implement.
- Reduce speed on hillsides or curves so there is no danger of tipping.
- Avoid driving too close to the edge of ditches or creeks.
- Do not transport implement on public roads without reflectors and slow moving vehicle emblem in daylight and with approved warning lights at night and other periods of poor visibility.
- Due to the width of some implements, use extra caution on highways, farm roads, and when approaching gates.
- Always be sure the implement is in the proper position for transport.
- Keep alert and watch the front as well as the rear when working with the implement.

**OWNER'S/
OPERATOR'S
MANUAL**

MODEL NO.'s

CTMG-48S

CTMG-48JD

APRIL 2016

COMPACT TRACTOR MINI GRAPPLE RAKE for Tractors 20-35 hp

**WHEN ORDERING REPAIR PARTS,
ALWAYS GIVE THE FOLLOWING INFORMATION:**

1. PART NUMBER
2. PART DESCRIPTION
3. MODEL NUMBER
4. NAME OF ITEM

**MAKE EVERY DAY
A HOLIDAY
FROM ACCIDENTS!**

WORKSAVER, INC.

P.O. BOX 100 LITCHFIELD, IL 62056-0100 (217) 324-5973
WEB: <http://www.worksaver.com> E-MAIL: sales@worksaver.com