

**OWNER'S/  
OPERATOR'S  
MANUAL**

**MODEL NO.'s**

**RB-1272**

**RB-1284**



**CAUTION**

For Safe Operation  
Read Rules And  
Instructions Carefully

SI NO LEEINGLES, PIDA AYUDA  
A AIGUIEN QUE SI LO LEA  
PARA QUE LE TRADUZCA LAS  
MEDIDAS DE SEGURIDAD.

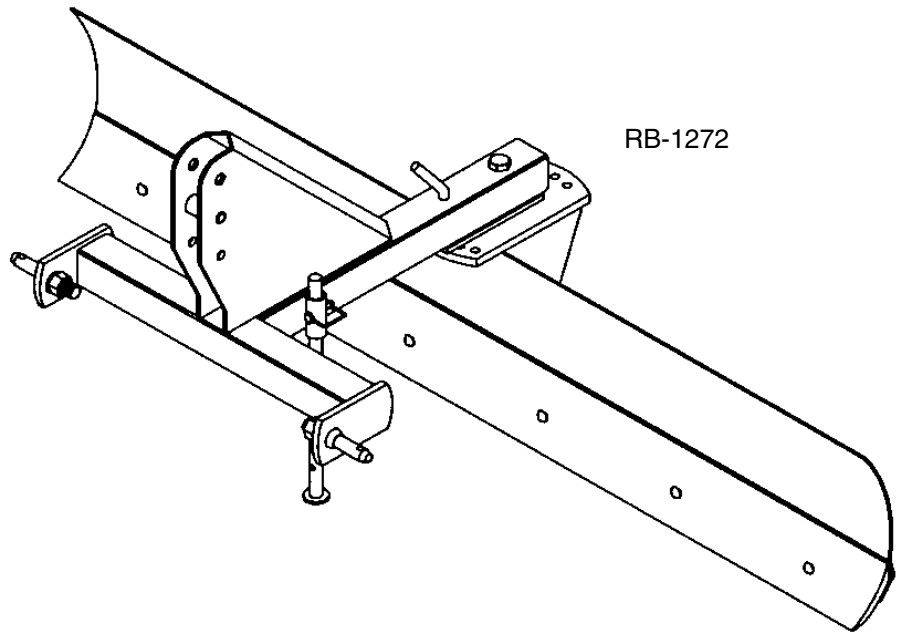

**3 PT. REAR  
MOUNTED BLADE**

For Cat. I 3 Pt. Hitch Tractors  
Models for up to 40 H.P.

**Safety Instructions  
Assembly & Mounting  
Operating Instructions**

**Maintenance  
Repair Parts**

 **CAUTION**

**THE FOLLOWING SAFETY PRECAUTIONS SHOULD BE THOROUGHLY UNDERSTOOD  
BEFORE ATTEMPTING TO BEGIN ASSEMBLING THIS MACHINE**

1. Select an area for assembly that is clean and free of any debris which might cause persons working on the assembly to trip.
2. Do not lift heavy parts or assemblies. Use crane, jack, tackle, fork trucks or other mechanical devices.
3. Preview the assembly instructions in your operator's manual before proceeding further.
4. If the assembly instructions call for parts or assemblies to be blocked up, use only blocking material that is in good condition and is capable of handling the weight of the assembly to be blocked. Also insure that the blocking material is on a clean, dry surface.
5. Never put hands, or any part of body, under blocked up assemblies if at all possible.
6. After completing assembly, thoroughly inspect the machine to be sure that all nuts, bolts, hydraulic fittings or any other fastened assemblies have been thoroughly tightened.
7. Before operating the machine, thoroughly read the operation section of your operator's manual.
8. Before operating, read the maintenance section of your operator's manual to be sure that any parts requiring lubrication, such as gearboxes, are full, to avoid any possible damage.
9. **Before operating equipment – If you have any questions regarding the proper assembly or operation, contact your dealer or representative.**

# TABLE OF CONTENTS

WARRANTY .....	2
SAFETY INFORMATION .....	3 - 5
SAFETY SIGNS .....	6
PREPARATION INSTRUCTIONS .....	7
OPERATING INSTRUCTIONS .....	9
OWNER MAINTENANCE .....	10
TROUBLE-SHOOTING GUIDE .....	11
PARTS LISTS .....	12 - 13

SI NO LEEINGLES, PIDA AYUDA A AIGUIEN QUE SI LO LEA PARA QUE LE TRADUZCA LAS MEDIDAS DE SEGURIDAD.

## STATEMENT OF POLICY

It is the policy of Worksaver, Inc. to improve its products where it is possible and practical to do so. Worksaver, Inc. reserves the right to make changes or improvements in design and construction at any time, without incurring the obligation to make these changes on previously manufactured units.

## TO THE OWNER:

Read this manual before using your 3 pt. Rear Blade. This manual is provided to give you the necessary operating and maintenance instructions for keeping your Loader Fork in top operating condition. Please read this manual thoroughly. Understand what each control is for and how to use it. Observe all safety signs on the machine and noted throughout the manual for safe operation of implement. Keep this manual handy for ready reference.

Like all mechanical products, it will require cleaning and upkeep.

Use only genuine Worksaver, Inc. service parts. Substitute parts will void the warranty and may not meet standards required for safe and satisfactory operation. Record the model and serial number of your Rear Blade here:

Model: \_\_\_\_\_ Serial Number: \_\_\_\_\_

---

---

## RETAIL CUSTOMER'S RESPONSIBILITY

**It is the Retail Customer and/or Operator's responsibility to read the Operator's Manual, to operate, lubricate, maintain, and store the product in accordance with all instructions and safety procedures. Failure of the operator to read the Operator's Manual is a misuse of this equipment.**

**It is the Retail Customer and/or Operator's responsibility to inspect the product and to have any part(s) repaired or replaced when continued operation would cause damage or excessive wear to other parts or cause a safety hazard.**

**It is the Retail Customer's responsibility to deliver the product to the authorized Worksaver Dealer, from whom he purchased it, for service or replacement of defective parts which are covered by warranty. Repairs to be submitted for warranty consideration must be made within forty-five (45) days of failure.**

**It is the Retail Customer's responsibility for any cost incurred by the Dealer for traveling to or hauling of the product for the purpose of performing a warranty obligation or inspection.**

# LIMITED WARRANTY

Worksaver warrants to the original purchaser of any new Rear 3 Pt. Blade, that the equipment be free from defects in material and workmanship for a period of one (1) year for non-commercial, state, and municipalities'. Use ninety (90) days for commercial use from date of retail sale.

Replacement or repair parts installed in the equipment covered by this warranty are warranted for ninety (90) days from the date of purchase of such part or to the expiration of the applicable new equipment warranty period, whichever occurs later.

Such parts shall be provided at no cost to the user during regular working hours. Worksaver reserves the right to inspect any equipment or parts which are claimed to have been defective in material or workmanship.

## SPECIAL WARRANTY PROVISION

Warranty shall only apply to defects in material and workmanship. In no case shall Worksaver, Inc. be liable to the purchaser for the bending or breakage of any part of the blade by abuse or misuse, such as striking hidden objects, grubbing stumps, or using tractors larger than the blades maximum horsepower rating whether intentional or unintentional.

## DISCLAIMER OF IMPLIED WARRANTIES & CONSEQUENTIAL DAMAGES

Worksaver's obligation under this warranty, to the extent allowed by law, is in lieu of all warranties, implied or expressed, including implied warranties of merchantability and fitness for a particular purpose and any liability for incidental and consequential damages with respect to the sale or use of the items warranted. Such incidental and consequential damages shall include but not be limited to: transportation charges other than normal freight charges; cost of installation other than cost approved by Worksaver; duty; taxes; charges for normal service or adjustments; loss of crops or any other loss of income; rental of substitute equipment, expenses due to loss, damage, detention or delay in the delivery of equipment or parts resulting from acts beyond the control of Worksaver.

## THIS WARRANTY SHALL NOT APPLY:

1. To vendor items which carry their own warranties, such as hydraulic cylinders, hoses, tires, and tubes.
2. If the unit has been subjected to misapplication, abuse, misuse, negligence, fire or other accident.
3. If parts not made or supplied by Worksaver have been used in connection with the unit, if, in sole judgement of Worksaver such use affects its performance, stability, or reliability.
4. If the unit has been altered or repaired outside of an authorized Worksaver dealership in a manner which, in the sole judgement of Worksaver affects its performance, stability or reliability.
5. To normal maintenance service and normal replacement items such as gearbox lubricant, hydraulic fluid, worn blades, or to normal deterioration of such things as belts and exterior finish, due to use or exposure.
6. To expendable or wear items such as teeth, chains, skid shoes, cutting edges, and other items that in the company's sole judgement is a wear item.

NO EMPLOYEE OR REPRESENTATIVE OF WORKSAVER IS AUTHORIZED TO CHANGE THIS WARRANTY IN ANY WAY OR GRANT ANY OTHER WARRANTY UNLESS SUCH CHANGE IS MADE IN WRITING AND SIGNED BY WORKSAVER'S SERVICE MANAGER, POST OFFICE BOX 100, LITCHFIELD, ILLINOIS 62056-0100.

# To the Owner/Operator/Dealer

All implements with moving parts are potentially hazardous. There is no substitute for a cautious, safe-minded operator who recognizes the potential hazards and follows reasonable safety practices. The manufacturer has designed this implement to be used with all its safety equipment properly attached to minimize the chance of accidents.

## BEFORE YOU START!!

**Read the safety messages on the implement and shown in your manual.  
Observe the rules of safety and common sense!**



**THIS SYMBOL MEANS**

- ATTENTION!
- BECOME ALERT!
- YOUR SAFETY IS INVOLVED!

THIS SAFETY ALERT SYMBOL IDENTIFIES IMPORTANT SAFETY WARNING MESSAGES. CAREFULLY READ EACH WARNING MESSAGE THAT FOLLOWS. FAILURE TO UNDERSTAND AND OBEY A SAFETY WARNING, OR RECOGNIZE A SAFETY HAZARD, COULD RESULT IN AN INJURY OR DEATH TO YOU OR OTHERS AROUND YOU. THE OPERATOR IS ULTIMATELY RESPONSIBLE FOR THE SAFETY OF HIMSELF, AS WELL AS OTHERS, IN THE OPERATING AREA OF THE TRACTOR AND ATTACHED EQUIPMENT.

---

## UNDERSTAND SIGNAL WORDS

Note the use of the signal words **DANGER**, **WARNING** and **CAUTION** with the safety messages. The appropriate signal word for each has been selected using the following guidelines:

**DANGER:** Indicates an imminently hazardous situation that, if not avoided, will result in death or serious injury. This signal word is to be limited to the most extreme situations typically for machine components which, for functional purposes, cannot be guarded.

**WARNING:** Indicates a potentially hazardous situation that, if not avoided, could result in death or serious injury, and includes hazards that are exposed when guards are removed. It may also be used to alert against unsafe practices.

**CAUTION:** Indicates a potentially hazardous situation that, if not avoided, may result in minor or moderate injury. It may also be used to alert against unsafe practices.

If you have questions not answered in this manual or require additional copies or the manual is damaged, please contact your dealer or the manufacturer directly.

---

## IMPORTANT SAFETY INFORMATION!

Read this manual, and the manual for your tractor, before assembly or operating, to acquaint yourself with the machines. It is the implement owner's responsibility, if this machine is used by any person other than yourself, is loaned or rented, to make certain that the operator, prior to operating:

1. Reads and understands the operator's manuals.
2. Is instructed in safe and proper use.



The use of this equipment is subject to certain hazards which cannot be protected against by mechanical means or product design. All operators of this equipment must read and understand this entire manual, paying particular attention to safety and operating instructions, prior to using. If there is something in this manual you do not understand, ask your supervisor, or your dealer, to explain it to you.

# SAFETY INSTRUCTIONS (continued)



Start tractor only when properly seated in the tractor seat. Starting a tractor in gear can result in injury or death. Do not mount or dismount the tractor while the tractor is moving. Mount or dismount the tractor only when the tractor and all moving parts are completely stopped.



Operate the tractor and/or implement controls only while properly seated in the tractor seat with the seat belt securely fastened around you. Inadvertent movement of the tractor or implement may cause serious injury or death.



Keep all helpers and bystanders fifty feet (50') from an operating power unit and attached equipment. Only properly trained people should operate this machine. It is recommended the tractor be equipped with a Rollover Protection System (ROPS) and a seat belt that is used. Always stop the tractor, set brake, shut off the engine, remove the ignition key, and lower loader and attachment to the ground before dismounting. Never leave equipment unattended with the engine running.



This equipment is dangerous to children and persons unfamiliar with its operation. The operator should be a responsible adult familiar with farm machinery and trained in this equipment's operations. **Do not allow persons to operate or assemble this unit until they have read this manual and have developed a thorough understanding of the safety precautions and of how it works.**



Only use a power unit equipped with a ROPS cab or rollover protective structure. Keep foldable ROPS systems in "locked up" position at all times. Keep seat belt fastened.



Always use two people to handle heavy, unwieldy components during assembly, installation, removal, or moving the implement.



Never place any part of your body where it would be in danger if movement should occur during assembly, installation, operation, maintaining, repairing, removal, or moving the implement.



A heavy load can cause instability of the tractor. Use extreme care during travel. Slow down on turns and watch out for bumps. The tractor may need front counter-weights to counter-balance the weight of the implement.



Never use alcoholic beverages or drugs which can hinder alertness or coordination while operating this equipment. Consult your doctor about operating this machine while taking prescription medications.





















Do not allow others to ride on the tractor with an operator. Riders are subject to injury such as being struck by foreign objects or being thrown off. Riders obstruct the operator's view resulting in unsafe operation. **Never allow anyone to ride on the implement!**



Before you operate the implement, check over all pins, bolts and connections to be sure all are securely in place. Replace any damaged or worn parts immediately.

# SAFETY INSTRUCTIONS (continued)

-  Never place yourself between the tractor and implement while implement is in operation.
-  Do not work under a raised implement unless it is securely blocked or held in position. Do not depend on the tractor hydraulic system to hold the implement in place.
-  Never allow children to operate or be around equipment.
-  Use stabilizer bars, adjustable sway chains, or sway blocks on your tractor lift arms to keep the implement from swinging side to side. Adjust as tightly as practical for best performance.
-  Keep alert and watch the front as well as the rear when working with the implement.
-  When maneuvering close to buildings or passing through narrow areas, be sure to allow sufficient clearance for the implement.
-  Do not operate close to ditches or creeks. Slow down when operating over rough ground.
-  Always be sure the implement is in the fully raised position when in transport.
-  When removing, changing the angle, or reversing the blade, be sure that your feet are never under the blade.
-  Use extreme caution when backfilling deep holes or trenches, or when working on slopes.
-  Avoid excessive speed during operation.
-  Make adjustments only when the implement is attached to the tractor.
-  When using the rear blade in a reverse position, use extra care. **Do not ram rear blade** into piles of dirt. Tractor lift arms and the rear blade are not built to take high impact loads in this position. **Ramming** backwards can also dislodge operator from seat and/or tractor controls, resulting in possible serious injury or death.
-  Always ease the tractor into the load. It may be necessary to reposition and take less “bite” on the material to move it safely.
-  Watch for and avoid hidden obstructions, i.e., buried pipes, rocks, concrete piers, uneven concrete slabs, stumps, etc., when operating.
-  Stop power unit and equipment immediately upon striking an obstruction. Turn off engine, remove key, inspect, and repair any damage before resuming operation.
-  Before leaving operator’s seat, lower lift arms and put attachment on the ground. Engage brake, stop engine, remove key, and unfasten seat belt.
-  Never perform service or maintenance with engine running.

# SAFETY SIGNS

---





**ATTENTION! BECOME ALERT! YOUR SAFETY IS INVOLVED!**  
**Replace Immediately If Damaged!**

**This SAFETY SIGN is located on the frame  
of your rear blade.  
Obey ALL Safety Warnings.**

***NOTE: If Safety Sign is missing or damaged, replace immediately.***

# CAUTION

Failure to follow safe operating practices can  
cause property damage and bodily injury.



1. Use tractor hitch sway bars to prevent side sway.
2. Never ram blade into dirt or snow piles with blade in reverse position. Ramming backwards can unseat operator from tractor or controls.
3. Keep fingers away from adjusting holes.

4. Reposition blade with tractor on level ground only to prevent blade from swinging or sliding into operator.
5. Watch for and avoid obstructions. Never hit mounds or ridges (especially ice and snow) at high speed as obstructions may be hidden.
6. Read other safety precautions in owner's manual.

Part #101033

---

## READ AND OBEY ALL SAFETY RULES

---

Use a clean, damp cloth to clean safety decals.

Avoid spraying too close to decals when using a pressure washer; high-pressure water can enter through very small scratches or under edges of decals causing them to peel or come off.

Replacement safety decals can be ordered free.

# INSTRUCTIONS

## TRACTOR REQUIREMENTS AND PREPARATION

The RB Series Rear Blades will fit most Category I tractors equipped with a standard 3 point hitch.

The RB-1272 and RB-1284 blades are rated for:  
Up to 40 hp two wheel drive tractors  
Up to 35 hp four wheel drive tractors

**NOTE:** The RB Series Blades will connect to Category I Quick Hitch.

Check the tractor's 3 point hydraulic lift system. It should operate up and down smoothly and hold its position when set. Refer to your tractor owner's manual or dealer for any adjustments necessary to put the 3 point hydraulic lift system in good working order. (I&T shop manuals will list most specifications and adjustment instructions – available from most farm equipment dealers.)

Tractor should be equipped with stabilizer bars, adjustable sway chains, or sway blocks to keep the implement from swinging side to side.

Smaller size tractors may need front counter weights to counter-balance the weight of the implement.

It is recommended that the tractor be equipped with a Rollover Protection System (ROPS) and a seat belt that is used.



### CAUTION

**Be sure your tractor is in good condition and properly equipped with counter weights. Read all the safety precautions and make sure all tractor operators are familiar with the safety rules of tractor operation.**



### WARNING

**Power unit must be equipped with ROPS or ROPS cab and seat belt. Keep seat belt securely fastened. Falling off power unit can result in death from being run over or crushed. Keep foldable ROPS systems in "locked up" position at all times.**

The operator is responsible for the safe operation of this equipment. The operator must be properly trained. Operators should be familiar with the tractor and attachment, and all safety practices before starting operation. Read the safety rules and safety signs on pages 3-6.

## ASSEMBLY AND MOUNTING

Preview the assembly instructions and the exploded view of the rear blade in your operator's manual and become familiar as to how the parts or assemblies go together.

Select an area for assembly that is clean and free from debris.

The two main subassemblies of the rear blade are heavy and awkward to handle. It is recommended that you have one or two helpers to complete the assembly.

Install lower link mounting pins in 3 point frame using lock washer and nut. Tighten all bolts and nuts.

Then attach pivot assembly to 3 point frame using bolt and washer. The bolt should be just loose enough for the moldboard assembly to pivot.

## CONNECTING REAR BLADE TO TRACTOR

The rear blade is compatible with Category 1, 3 point tractors equipped with side swing-type lower lift arms.

1. To avoid interference with the rear blade, adjust tractor drawbar to the shortest and highest position.
2. Attach the tractor's lower lift arms to the rear blade and secure in place with lock pin.
3. Tractor must be equipped with stabilizer bars, adjustable sway chains, or sway blocks to keep the implement from swinging side to side.

For Category 1 Quick Hitch application, order optional bushing kit part #862500 (one pair); place bushing over draw pin and fasten with roll pin. (RB Models only.)

4. Attach the tractor's top link to the top of the rear blade's mast and secure with the top link pin and retaining pin supplied with the top link.

For Quick Hitch application, the top center hitch hook will seat into welded 1 1/4" diameter pin. This pin does not interfere when unit is used with a standard 3 point hitch.



# INSTRUCTIONS (continued)

## IMPORTANT

■ **Make sure blade is at least 6" (15 cm) from tractor tires throughout complete range of 3 point hitch operation.**

Level the 3 point mount frame and moldboard with 3 point connecting links and top link. Adjusting the top link length will change the fore and aft pitch of the blade.

Lengthening the top link will cause the blade to contact the ground with a sharper pitch and feed itself into the ground more readily.

## ADJUSTMENTS

---

### ANGLING

Remove lock pin and adjustment pin assembly.

The blade may be set 15 degrees or 30 degrees to the left or right for forward grading.

For backfilling, the blade may be set 15 degrees to the left or right. Replace adjustment pin and lock pin.

### REVERSING

For most tractors, the blade may be rotated 360 degrees without unhooking from the tractor. To rotate without unhooking, remove lock pin and adjustment pin assembly. Rotate to desired position, replace pin assembly and secure with lock pin.

## GENERAL SAFETY

---

The designed and tested safety of this machine depends on it being operated within the limitations as explained in this manual. Be familiar with and follow all safety rules in the manual, on the blade and on the tractor.

The safe operation of this machine is the responsibility of the owner/operator. The operator should be familiar with the blade and tractor and all safety practices before starting operation. Read the safety rules.

Never let anyone stand between the rear of the tractor and the rear blade while the tractor is backing up to connect to the blade. Always stand to the side until tractor has come to a complete stop and the brakes set or the tractor shift placed in "PARK".



## CAUTION

Watch for and avoid hidden obstructions, i.e., buried pipes, rocks, concrete piers, or uneven slabs of concrete, when operating, or blade damage may occur. This is especially true when removing snow.

Stop tractor and implement immediately upon striking an obstruction. Turn off engine, remove key, inspect, and repair any damage before resuming operation.

Always wear relatively tight and belted clothing to avoid entanglement in moving parts. Wear sturdy, rough-soled work shoes and protective equipment for eyes, hair, hands, hearing, and head.



## WARNING

Power unit must be equipped with ROPS or ROPS cab and seat belt. Keep seat belt securely fastened. Falling off power unit can result in death from being run over or crushed. Keep foldable ROPS systems in "locked up" position at all times.

Never allow children or untrained persons to operate equipment.

---

✓ Keep children away from danger all day, every day.

✓ Please work, drive, play, and live each day with care and concern for your safety and that of your family and fellow citizens.

# INSTRUCTIONS (continued)

## OPERATION

---

Attaching the blade to the tractor increases the overall length of the working unit. Allow additional clearance for the blade to swing when turning.

Your rear blade can be used for all types of blade work, including casting, side ditching, leveling, grading, bulldozing, and snow removal.

**1. CASTING:** The blade should be angled horizontally – only enough to allow the material to slide along it easily. The vertical angle (tilt) of the blade must be set to suit conditions. This is controlled by the lift arm leveling assembly (turnbuckle) on the tractor 3 point hitch.

**2. SIDE DITCHING:** The horizontal angle should be at its sharpest. This is obtained by removing the shift pin and turning the moldboard so that the last hole in the circle plate is in line with the shift pin hole, then replace the shift pin.

The vertical angle of the blade (tilt) is obtained with the adjustable turnbuckles on the tractor 3 point hitch. For the sharpest angle, lengthen the center link on the tractor.

**3. LEVELING:** The blade should be straight across, i.e., 90° to the line of travel of the tractor, in other words, 0° horizontal angle.

There should be 0° vertical angle, i.e., the lift arms on the tractor 3 point hitch should be parallel to the ground.

The cutting pitch of the blade should be the opposite of that used in side ditching and casting, with the cutting edge behind the top edge of the moldboard. This adjustment is made with tractor center link.

**4. BULLDOZING:** When bulldozing, the blade is in reverse position. Depending on the job, the casting, side ditching, or leveling position may be used. Snow removal can also be done with the blade in this position (blade in reverse, cutting edge away from tractor).

**NOTE:** Most blades are damaged in this position – use extra care – DO NOT RAM blade into snow or dirt piles!



## WARNING

When using the rear blade in a reverse position use extra care – **DO NOT RAM REAR BLADE** into obstructions (including hard packed snow and dirt piles)! Tractor lift arms and the rear blade are not built to take high impact loads in this position. **RAMMING backwards** can also dislodge operator from seat and/or tractor controls, resulting in possible serious injury or death.

**5. GRADING:** Grading is a combination of casting, side ditching, and leveling. Snow removal can also be done with the blade in this position (cutting edge toward the tractor).

These suggestions are generalities; best results will be obtained after some experience.

**NOTE:** Do not load either end of the blade heavily. Try to balance the load on both ends of the blade.

## TRANSPORTING

---

Pay particular close attention to the Safety Messages regarding transport. Avoid unnecessary injuries and equipment damage by exercising cautious, conscientious travel procedures.

Attaching the blade to the tractor increases the overall length of the working unit. Allow additional clearance for the blade to swing when turning.

Raise the blade as high as possible for transporting. Always transport blade with blade centered on tractor. Never attempt road travel with blade offset into the traffic lane.

**OBEY ALL  
SAFETY WARNINGS!!**

# OWNER SERVICE

---

The information in this section is written for operators who possess basic mechanical skills. If you need help, your dealer has trained service technicians available. For your protection, read and follow the safety information in this manual.

## **WARNING**

**NEVER GO UNDERNEATH EQUIPMENT. Never place any part of the body underneath equipment or between moveable parts even when the engine has been turned off. Hydraulic system leak down, hydraulic system failures, mechanical failures, or movement of control levers can cause equipment to drop or rotate unexpectedly and cause severe injury or death.**

- Service work does not require going underneath.
- Read Manual for service instructions or have service performed by a qualified dealer.

## **WARNING**

**Keep all persons away from operator control area while performing adjustments, service, or maintenance.**

**Before dismantling power unit or performing any service or maintenance, follow these steps: disengage power to equipment, lower the 3 point hitch and all raised components to the ground, operate valve levers to release any hydraulic pressure, set parking brake, stop engine, remove key, and unfasten seat belt.**

## **OPTIONS**

---

The optional skid shoes provide cutting height adjustment to reduce the chance of blade or surface damage during snow removal on gravel or loose stone driveways. Order 343435 Model SK-5 Skid Shoes.

## **MAINTENANCE**

---

Inspect the blade for loose, damaged or worn parts and adjust or replace if needed.

Repaint parts where paint is worn or scratched to prevent rust.

Check all bolts and nuts to be sure they are tight.

## **REPLACING CUTTING EDGE**

All rear blade models use 1/2" x 6" (12.7 x 152 mm) cutting edges. They are reversible.

To service the rear blade when attached to the tractor, it must be blocked up off the ground.

1. Raise the rear blade and lower the parking stand.
2. Place a 4" x 4" block under the parking stand. Then lower the rear blade so the parking stand rests securely on the block. (RB Models only.)
3. Place two smaller blocks under the cutting edge so when the cutting edge is loose from the blade it doesn't fall directly on the ground (these blocks will also support the cutting edge when bolting it back on the blade).

**NOTE:** Do not block the machine any higher than necessary to remove cutting edge.

4. Refer to the Parts Drawings/Schematics on page 12 for proper parts identification. Remove the hex nuts and plow bolts that are securing the cutting edge to the moldboard. Turn the cutting edge over and use the new edge, or replace it if both edges have been used.
5. Attach the cutting edge to the rear blade and secure with plow bolts and hex nuts previously removed.

## **STORING SAFELY**

---

- Always store blade in a clean, dry location away from children and livestock.
- Storage location should be level and solid to make hitching and unhitching easy.

# TROUBLE-SHOOTING GUIDE

---

<b>PROBLEM</b>	<b>POSSIBLE CAUSE</b>	<b>POSSIBLE REMEDY</b>
<b>Blade will not penetrate soil.</b>	<ol style="list-style-type: none"><li>1. Cutting edge dull.</li><li>2. Blade set too straight.</li><li>3. Soil too hard.</li></ol>	<p>Replace cutting edge.</p> <p>Increase 3 pt. hitch toplink length.</p> <p>Loosen soil with scarifiers or disk. Wait for rain.</p>
<b>Moldboard digging in too much.</b>	<ol style="list-style-type: none"><li>1. Blade pitch excessive.</li><li>2. Soft ground.</li></ol>	<p>Adjust toplink (shorten).</p> <p>Install skid shoes. Wait for dryer soil.</p>
<b>3 Pt. hitch frame bent.</b>	<ol style="list-style-type: none"><li>1. Hitting hidden objects in backfill position or ramming backwards into hard piles of snow or soil.</li><li>2. Using too large of tractor or one that is heavily weighted and has four wheel drive.</li></ol>	<p>Use slow speed when in unknown soil conditions. Always backfill at slow speed.</p> <p>Preferably use tractor of recommended horsepower. Slow down and use extra care.</p>
<b>Bent moldboard.</b>	<ol style="list-style-type: none"><li>1. Hitting hidden objects.</li><li>2. Using too large of tractor or one that is heavily weighted and has four wheel drive.</li><li>3. Hitting end of moldboard on stumps, concrete curb, or corner of building.</li></ol>	<p>Know soil conditions. Use slow speed when soil conditions unknown.</p> <p>Preferably use tractor of recommended horsepower. Slow down and use extra care.</p> <p>Have operator use care when driving close to obstacles.</p>
<b>Unable to hold level grade.</b>	<ol style="list-style-type: none"><li>1. Tractor draft control lifting blade.</li><li>2. Soil too hard.</li></ol>	<p>Set tractor draft control.</p> <p>Loosen soil with scarifiers or disk.</p>

## REAR BLADE PARTS (Models RB-1272 & RB-1284)

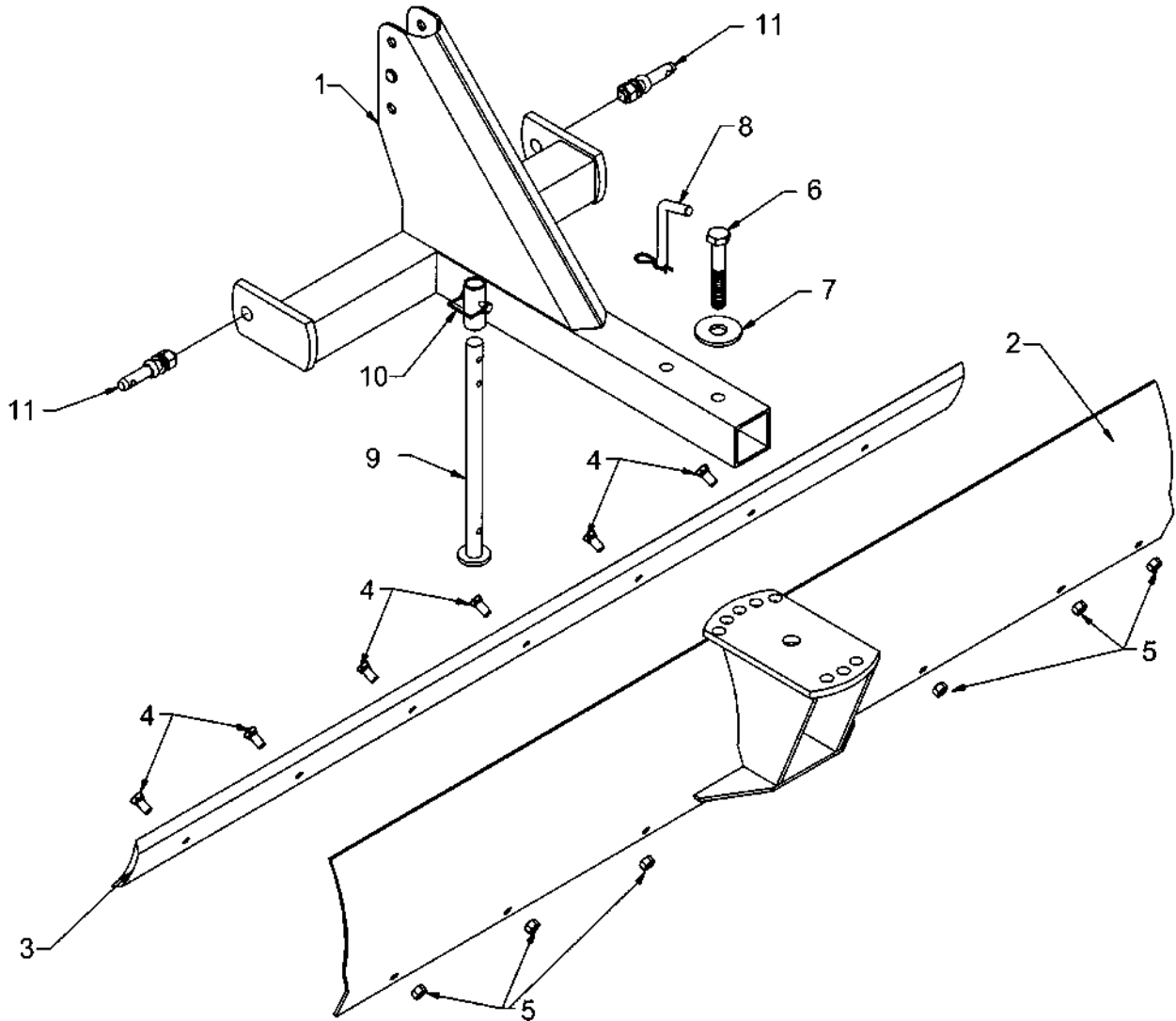

Ref. No.	Part No.	Description	No. Req'd.
1	343410	Blade 3pt. Mount Weldment	1
	346706	Moldboard Assembly (RB-1272) (Includes Items 2 Thru 5)	1
	346716	Moldboard Assembly (RB-1284) (Includes Items 2 Thru 5)	1
2	346710	Moldboard Weldment (RB-1272)	1
	346719	Moldboard Weldment (RB-1284)	1
3	350405	Cutting Edge, 1/2 x 6 x 71 1/2	1
	346731	Cutting Edge, 1/2 x 6 x 83 1/2	1
4	2503045	Bolt, Plow 5/8-11NC x 1 1/2 Gr. 5	Var.
5	2500094	Nut, 5/8-11NC Hex Toplock Gr. 5	Var.
6	2503310	Bolt, Hex 1-8NC x 5 Gr. 5	1
7	2501001	Washer, 1" Medium Flat	1
8	343185	Pin, 1/2 x 4 w/Clip	1
9	343430	Stand Tube Weldment (RB2060L)	1
10	590194	Lock Pin 5/16 (AK-2907)	1
11	590108	Draw Pin Cat. I (AK-578)	2
NS	101033	Safety Sign-Caution (Blades)	1
NS	101264	Safety Sign-Notice (40H.P.)RB-1272	1
NS	101265	Safety Sign-Notice (40H.P.)RB-1284	1

# REAR BLADE OPTIONS

(For RB-1272 & RB-1284 Models)

## SK-5 SKID SHOES PARTS

The optional skid shoes provide cutting height adjustment to reduce the chance of blade causing surface damage during snow removal. This option is very helpful when plowing gravel or loose stone driveways.

### SKID SHOE INSTALLATION

Attach the skid shoe mounting bracket to the outer cutting edge holes from each end of the moldboard.

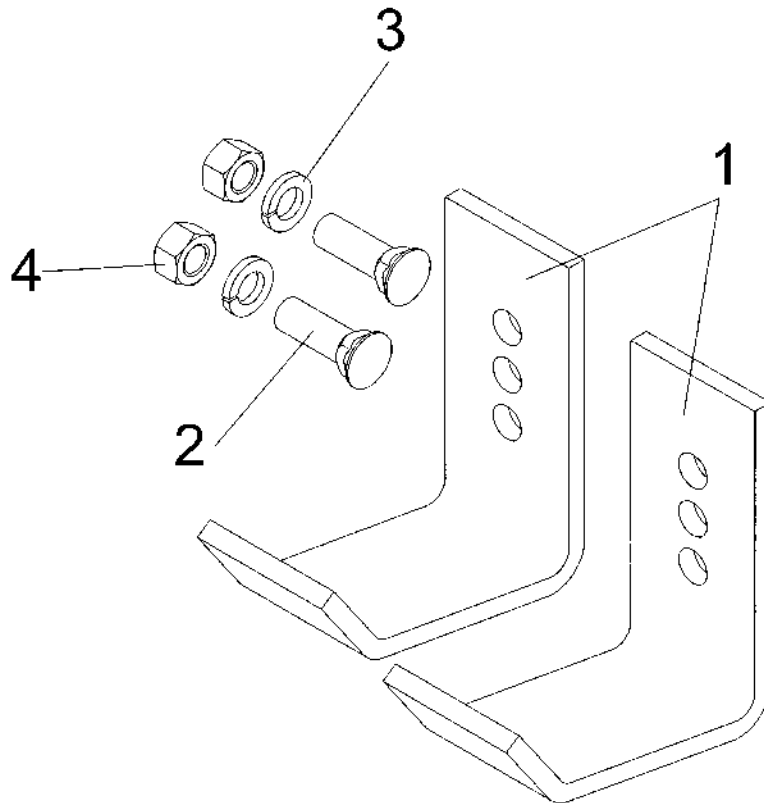

ITEM	PART No.	DESCRIPTION	QTY
	343435	Skid Shoe (Kit)	1
1	343436	Skid Shoe	2
2	2503179	Plow Bolt, 5/8-11 x 2 G5	2
3	2502007	Washer, $\frac{5}{8}$ " Spring Lock	2
4	2500013	Nut, Hex 5/8-11NC	2



# **SAFETY REQUIREMENTS**

**AVOID ACCIDENTS BY FOLLOWING ALL OF THE SAFETY REQUIREMENTS LISTED BELOW.**

- Machinery should be operated only by those who are responsible and are authorized to do so.
- Stop the engine, lower all equipment, lock the brakes, and remove the ignition key before dismounting from the tractor.
- Never stand between tractor and implement while tractor is being backed to hitch.
- Loose fitting clothing should not be worn, to avoid catching on various parts.
- Detach implement in area where children normally do not play.
- When performing adjustments or maintenance on an implement, first lower it to the ground or block it securely at a workable height.
- Only a qualified operator should be permitted on tractor when in operation; no riders allowed.
- Make certain everyone is in the clear before starting tractor or raising or lowering equipment.
- Operate the tractor and implement only while seated in the driver's seat.
- Reduce speed when transporting mounted implements to avoid bouncing and momentary loss of steering control.
- A heavy load can cause instability of the tractor. Use extreme care during road travel. Slow down on turns and watch out for bumps. Tractor may need front counterweights to counter-balance the weight of the implement.
- Reduce speed on hillsides or curves so there is no danger of tipping.
- Avoid driving too close to the edge of ditches or creeks.
- Do not transport implement on public roads without reflectors and slow moving vehicle emblem in daylight and with approved warning lights at night and other periods of poor visibility.
- Due to the width of some implements, use extra caution on highways, farm roads, and when approaching gates.
- Always be sure the implement is in the proper position for transport.
- Keep alert and watch the front as well as the rear when working with the implement.

## **OWNER'S/ OPERATOR'S MANUAL**

### **MODEL NO.'s**

**RB-1272**

**RB-1284**

**SI NO LEEINGLES, PIDA AYUDA  
A AIGUIEN QUE SI LO LEA  
PARA QUE LE TRADUZCA LAS  
MEDIDAS DE SEGURIDAD.**

FEBRUARY 2015

## **3 PT. REAR MOUNTED BLADE**

For Cat. I 3 Pt. Hitch Tractors  
Models for up to 40 H.P.

**WHEN ORDERING REPAIR PARTS,  
ALWAYS GIVE THE FOLLOWING INFORMATION:**

1. PART NUMBER
2. PART DESCRIPTION
3. MODEL NUMBER
4. NAME OF ITEM

**MAKE EVERY DAY  
A HOLIDAY  
FROM ACCIDENTS!**

**WORKSAVER, INC.**

P.O. BOX 100 LITCHFIELD, IL 62056-0100 (217) 324-5973  
WEB: <http://www.worksaver.com> E-MAIL: [sales@worksaver.com](mailto:sales@worksaver.com)