

OWNER'S/ OPERATOR'S MANUAL

MODEL NO.'s

MCR-6

MCR-7

LRHD-6

LRHD-7

LRHD-8

CAUTION

For Safe Operation
Read Rules And
Instructions Carefully

SI NO LEEINGLES, PIDA AYUDA
A AIGUIEN QUE SI LO LEA
PARA QUE LE TRADUZCA LAS
MEDIDAS DE SEGURIDAD.

LRHD-7

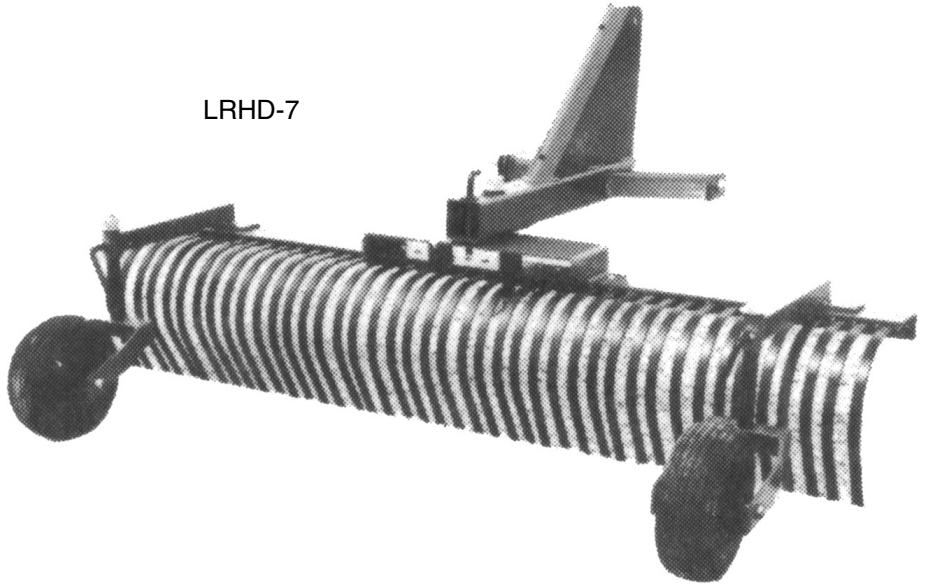

(Rake shown with optional gauge wheels)

3 PT. LANDSCAPE RAKE

Safety Instructions

Tractor Preparation

Operating Instructions

Assembly & Mounting

Maintenance

Repair Parts

CAUTION

**THE FOLLOWING SAFETY PRECAUTIONS SHOULD BE THOROUGHLY UNDERSTOOD
BEFORE ATTEMPTING TO BEGIN ASSEMBLING THIS MACHINE**

1. Select an area for assembly that is clean and free of any debris which might cause persons working on the assembly to trip.
2. Do not lift heavy parts or assemblies. Use crane, jack, tackle, fork trucks or other mechanical devices.
3. Preview the assembly instructions in your operator's manual before proceeding further.
4. If the assembly instructions call for parts or assemblies to be blocked up, use only blocking material that is in good condition and is capable of handling the weight of the assembly to be blocked. Also insure that the blocking material is on a clean, dry surface.
5. Never put hands, or any part of body, under blocked up assemblies if at all possible.
6. After completing assembly, thoroughly inspect the machine to be sure that all nuts, bolts, hydraulic fittings or any other fastened assemblies have been thoroughly tightened.
7. Before operating the machine, thoroughly read the operation section of your operator's manual.
8. Before operating, read the maintenance section of your operator's manual to be sure that any parts requiring lubrication, such as gearboxes, are full, to avoid any possible damage.
9. **Before operating equipment – If you have any questions regarding the proper assembly or operation, contact your dealer or representative.**

TABLE OF CONTENTS

WARRANTY	2
SAFETY INFORMATION	3
SAFETY SIGNS	6
PREPARATION INSTRUCTIONS	7
ASSEMBLY	7
OPERATING INSTRUCTIONS	9
SERVICE INSTRUCTIONS	10
TROUBLE-SHOOTING	11
PARTS DRAWINGS & LISTS	12-14

SI NO LEEINGLES, PIDA AYUDA A AIGUIEN QUE SI LO LEA PARA QUE LE TRADUZCA LAS MEDIDAS DE SEGURIDAD.

STATEMENT OF POLICY

It is the policy of Worksaver, Inc. to improve its products where it is possible and practical to do so. Worksaver, Inc. reserves the right to make changes or improvements in design and construction at any time, without incurring the obligation to make these changes on previously manufactured units.

TO THE OWNER:

Read this manual before using your Landscape Rake. This manual is provided to give you the necessary operating and maintenance instructions for keeping your Landscape Rake in top operating condition. Please read this manual thoroughly. Understand what each control is for and how to use it. Observe all safety signs on the machine and noted throughout the manual for safe operation of implement. Keep this manual handy for ready reference.

Like all mechanical products, it will require cleaning and upkeep.

Use only genuine Worksaver, Inc. service parts. Substitute parts will void the warranty and may not meet standards required for safe and satisfactory operation. Record the model and serial number of your Landscape Rake here:

Model: _____ Serial Number: _____

RETAIL CUSTOMER'S RESPONSIBILITY

It is the Retail Customer and/or Operator's responsibility to read the Operator's Manual, to operate, lubricate, maintain, and store the product in accordance with all instructions and safety procedures. Failure of the operator to read the Operator's Manual is a misuse of this equipment.

It is the Retail Customer and/or Operator's responsibility to inspect the product and to have any part(s) repaired or replaced when continued operation would cause damage or excessive wear to other parts or cause a safety hazard.

It is the Retail Customer's responsibility to deliver the product to the authorized Worksaver Dealer, from whom he purchased it, for service or replacement of defective parts which are covered by warranty. Repairs to be submitted for warranty consideration must be made within forty-five (45) days of failure.

It is the Retail Customer's responsibility for any cost incurred by the Dealer for traveling to or hauling of the product for the purpose of performing a warranty obligation or inspection.

LIMITED WARRANTY



Worksaver warrants to the original purchaser of any new 3 Pt. Landscape Rake, that the equipment be free from defects in material and workmanship for a period of one (1) year for non-commercial, state, and municipalities. Use sixty (60) days for commercial use from date of retail sale.

Replacement or repair parts installed in the equipment covered by this warranty are warranted for ninety (90) days from the date of purchase of such part or to the expiration of the applicable new equipment warranty period, whichever occurs later.

Such parts shall be provided at no cost to the user during regular working hours. Worksaver reserves the right to inspect any equipment or parts which are claimed to have been defective in material or workmanship.

DISCLAIMER OF IMPLIED WARRANTIES & CONSEQUENTIAL DAMAGES

Worksaver's obligation under this warranty, to the extent allowed by law, is in lieu of all warranties, implied or expressed, including implied warranties of merchantability and fitness for a particular purpose and any liability for incidental and consequential damages with respect to the sale or use of the items warranted. Such incidental and consequential damages shall include but not be limited to: transportation charges other than normal freight charges; cost of installation other than cost approved by Worksaver; duty; taxes; charges for normal service or adjustments; loss of crops or any other loss of income; rental of substitute equipment, expenses due to loss, damage, detention or delay in the delivery of equipment or parts resulting from acts beyond the control of Worksaver.

THIS WARRANTY SHALL NOT APPLY:

1. To vendor items which carry their own warranties, such as hydraulic motors, tires, and tubes.
2. If the unit has been subjected to misapplication, abuse, misuse, negligence, fire or other accident.
3. If parts not made or supplied by Worksaver have been used in connection with the unit, if, in sole judgement of Worksaver such use affects its performance, stability, or reliability.
4. If the unit has been altered or repaired outside of an authorized Worksaver dealership in a manner which, in the sole judgement of Worksaver affects its performance, stability or reliability.
5. To normal maintenance service and normal replacement items such as gearbox lubricant, hydraulic fluid, worn tines, or to normal deterioration of such things as belts and exterior finish, due to use or exposure.
6. To expendable or wear items such as tines, chains, sprockets, belts, springs and other items that in the company's sole judgement is a wear item.

NO EMPLOYEE OR REPRESENTATIVE OF WORKSAVER IS AUTHORIZED TO CHANGE THIS WARRANTY IN ANY WAY OR GRANT ANY OTHER WARRANTY UNLESS SUCH CHANGE IS MADE IN WRITING AND SIGNED BY WORKSAVER'S SERVICE MANAGER, POST OFFICE BOX 100, LITCHFIELD, ILLINOIS 62056-0100.



To the Owner/Operator/Dealer

All implements with moving parts are potentially hazardous. There is no substitute for a cautious, safe-minded operator who recognizes the potential hazards and follows reasonable safety practices. The manufacturer has designed this implement to be used with all its safety equipment properly attached to minimize the chance of accidents.

BEFORE YOU START!!

**Read the safety messages on the implement and shown in your manual.
Observe the rules of safety and common sense!**





THIS SYMBOL MEANS

- ATTENTION!
- BECOME ALERT!
- YOUR SAFETY IS INVOLVED!

THIS SAFETY ALERT SYMBOL IDENTIFIES IMPORTANT SAFETY WARNING MESSAGES. CAREFULLY READ EACH WARNING MESSAGE THAT FOLLOWS. FAILURE TO UNDERSTAND AND OBEY A SAFETY WARNING, OR RECOGNIZE A SAFETY HAZARD, COULD RESULT IN AN INJURY OR DEATH TO YOU OR OTHERS AROUND YOU. THE OPERATOR IS ULTIMATELY RESPONSIBLE FOR THE SAFETY OF HIMSELF, AS WELL AS OTHERS, IN THE OPERATING AREA OF THE TRACTOR AND EQUIPMENT.

UNDERSTAND SIGNAL WORDS

 **DANGER** Indicates an imminently hazardous situation that, if not avoided, WILL result in DEATH OR VERY SERIOUS INJURY.

 **WARNING** Indicates a imminently hazardous situation that, if not avoided, COULD result in DEATH OR SERIOUS INJURY.

 **CAUTION** Indicates a imminently hazardous situation that, if not avoided, MAY result in MINOR INJURY.

NOTE: *Identifies points of particular interest for more efficient and convenient operation or repair.*

Important Safety Information!

Read this manual, and the manual for your tractor, before assembly or operating, to acquaint yourself with the machine. It is the equipment owner's responsibility, if this equipment is used by any person other than yourself, is loaned or rented, to make certain that the operator, prior to operating:

1. Reads and understands the operator's manuals.
2. Is instructed in safe and proper use.

 The use of this equipment is subject to certain hazards which cannot be protected against by mechanical means or product design. All operators of this equipment must read and understand this entire manual, paying particular attention to safety and operating instructions, prior to using. If there is something in this manual you do not understand, ask your supervisor, or your dealer, to explain it to you.

SAFETY INSTRUCTIONS (continued)



Keep all helpers and bystanders fifty feet (50') from operating equipment. Only properly trained people should operate this tractor and attached implement. It is recommended the tractor be equipped with a Rollover Protection System (ROPS) and a seat belt that is used. Always stop the tractor, set brake, shut off the tractor engine, remove the tractor key, and lower implement to the ground before dismounting tractor. Never leave equipment unattended with the tractor running.



All equipment is potentially hazardous. There is no substitute for a cautious, safe-minded operator who recognizes potential hazards and follows reasonable safety practices.



Start tractor only when properly seated in the tractor seat. Starting a tractor in gear can result in injury or death. Do not mount or dismount the tractor while the tractor is moving. Mount or dismount the tractor only when the tractor and all moving parts are completely stopped.



Operate the tractor and/or implement controls only while properly seated in the tractor seat with the seat belt securely fastened around you. Inadvertent movement of the tractor or implement may cause serious injury or death.



Only use a power unit equipped with a ROPS cab or rollover protective structure. Keep foldable ROPS systems in "locked up" position at all times. Keep seat belt fastened.



BEFORE leaving the tractor seat, lower the implement, set the parking brake and/or set the tractor transmission in parking gear, disengage the PTO, stop the engine, remove the key, and wait for all moving parts to stop. Place the tractor shift lever into a low range or parking gear to prevent the tractor from rolling. Never dismount a tractor that is moving or while the engine is running. Operate the tractor controls from the tractor seat only.



Never leave the tractor and implement unattended while the implement is in the lifted position. Accidental operation of lifting lever or a hydraulic failure may cause sudden drop of unit with injury or death by crushing.



Never use alcoholic beverages or drugs which can hinder alertness or coordination while operating equipment. Consult your doctor about operating tractor and implement while taking prescription medications.



Do not allow children or others to ride on the tractor with an operator. Riders are subject to injury such as being struck by foreign objects or being thrown off. Riders obstruct the operator's view resulting in unsafe operation. **Never allow anyone to ride on the implement!**



Never allow children to play on or around tractor or implement. Children can slip or fall off the equipment and be injured or killed. Inadvertent contact with controls can cause the implement to shift or fall crushing themselves or others.



Do not allow anyone who is not familiar with the safety rules and operation instructions to use this equipment.



Do not allow others to ride on the tractor with an operator. Riders are subject to injury such as being struck by foreign objects or being thrown off. Riders obstruct the operator's view resulting in unsafe operation. **Never allow anyone to ride on the implement!**





















A heavy load can cause instability of the tractor. Use extreme care during travel. Slow down on turns and watch out for bumps. The tractor may need front counter-weights to counter-balance the weight of the implement.



Keep alert and watch the rear as well as the front when working with the attached implements.

SAFETY INSTRUCTIONS (continued)

-  Never allow children to operate or be around equipment.
-  Use stabilizer bars, adjustable sway chains, or sway blocks on your tractor lift arms to keep the implement from swinging side to side. Adjust as tightly as practical for best performance.
-  Keep alert and watch the front as well as the rear when working with the implement.
-  When maneuvering close to buildings or passing through narrow areas, be sure to allow sufficient clearance for the implement.
-  Do not operate close to ditches or creeks. Slow down when operating over rough ground.
-  Always be sure the implement is in the fully raised position when in transport.
-  When removing, changing the angle, or reversing the rake, be sure that your feet are never under the rake.
-  Use extreme caution when backfilling deep holes or trenches.
-  Be careful to avoid catching the rake on stumps or other immovable objects.
-  Use care when working on slopes.
-  Avoid excessive speed during operation.
-  Make adjustments only when the implement is attached to the tractor.
-  When using the rake in a reverse position, use extra care. **Do not ram rake** into piles of dirt. Tractor lift arms and the rake are not built to take high impact loads in this position. **Ramming** backwards can also dislodge operator from seat and/or tractor controls, resulting in possible serious injury or death.
-  Always ease the tractor into the load. It may be necessary to reposition and take less “bite” on the material to move it safely.
-  Operating spring steel rake tines may suddenly fling rocks and clods. Keep all bystanders 50 feet away and operator must wear safety glasses.
-  Watch for and avoid hidden obstructions, i.e., buried pipes, rocks, concrete piers, uneven concrete slabs, stumps, etc., when operating.
-  Stop power unit and equipment immediately upon striking an obstruction. Turn off engine, remove key, inspect, and repair any damage before resuming operation.
-  Before leaving operator’s seat, lower lift arms and put attachment on the ground. Engage brake, stop engine, remove key, and remove seat belt.
-  Never perform service or maintenance with engine running.

SAFETY SIGNS

CAUTION

Failure to follow safe operating practices can cause property damage and bodily injury.

- Read operating instructions and safety precautions in manual.
- Use caution when using rake in reverse position. Striking an obstruction can unseat operator from tractor or controls.
- Keep fingers away from adjusting holes.

101148

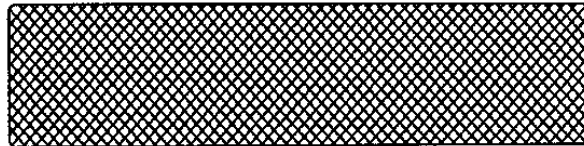

Red Reflector #101260

BE CAREFUL!

Use a clean, damp cloth to clean safety decals. Avoid spraying too close to decals when using a pressure washer; high-pressure water can enter through very small scratches or under edges of decals causing them to peel or come off.

REMEMBER:

If Safety Signs have been damaged, removed, become illegible or parts replaced without Signs, new Safety Signs must be applied. New Safety Signs are available from your authorized distributor or factory.

REPLACING SAFETY SIGNS

1. Clean the area of application with nonflammable solvent.
2. Wash the same area with soap and water.
3. Allow the surface to fully dry.
4. Remove the backing from the safety sign exposing the adhesive surface.
5. Apply the safety sign to the location shown in the parts diagram.
6. Smooth out any bubbles.

Helpful Hints: (1) Decals adhere to a warm surface better than a cold surface. (2) Applying heat (from a hair dryer) will greatly improve your ability to remove a damaged decal before preparing the surface for installation of a new one.

INSTRUCTIONS

TRACTOR REQUIREMENTS AND PREPARATION

The MCR and LRHD Series Landscape Rakes will fit most Category I tractors equipped with a standard 3 point hitch.

Check the tractor's 3 point hydraulic lift system. It should operate up and down smoothly and hold its position when set. Refer to your tractor owner's manual or dealer for any adjustments necessary to put the 3 point hydraulic lift system in good working order. (I&T shop manuals will list most specifications and adjustment instructions – available from most farm equipment dealers.)

Tractor should be equipped with stabilizer bars, adjustable sway chains, or sway blocks to keep the implement from swinging side to side.

Smaller size tractors may need front counter weights to counter-balance the weight of the implement.



WARNING

Power unit must be equipped with ROPS or ROPS cab and seat belt. Keep seat belt securely fastened. Falling off power unit can result in death from being run over or crushed. Keep foldable ROPS systems in “locked up” position at all times.



CAUTION

Be sure your tractor and loader is in good condition. Read all the safety precautions and make sure all equipment operators are familiar with the safety rules of operation.

The operator is responsible for the safe operation of this equipment. The operator must be properly trained. Operators should be familiar with the tractor and attachment, and all safety practices before starting operation. Read the safety rules and safety signs on pages 3-6.

PACKAGING

The landscape rake is shipped as two bundles:

1. Main Frame with pull pins, bolts and nuts.
2. Rake Tine Bar Assembly (Teeth installed).

ASSEMBLY AND MOUNTING

Preview the assembly instructions and the exploded view of the landscape rake in your operator's manual and become familiar as to how the parts or assemblies go together.

Select an area for assembly that is clean and free from debris.

The two main subassemblies of the landscape rake are heavy and awkward to handle. It is recommended that you have one or two helpers to complete the assembly.

1. On the MCR models, assemble the “A” frame as shown in the exploded parts view (pg. 12).
2. It is suggested that you mount the main frame on the 3 point hitch of your tractor before assembling the landscape rake as follows:
 - a. Lower the 3 point hitch on your tractor to facilitate mounting of the main frame of the rake to the tractor.
 - b. Insert the lift arm pins on the main frame into the ball sockets in the lift arms of the tractor 3 point hitch. Pin in place with linchpins (not furnished).
 - c. Attach the mast of the main frame to the tractor by installing the tractor center (or top) link with a top link pin (not furnished).

NOTE: Use stabilizer bars, adjustable sway chains, or sway blocks on your tractor lift arms to keep the landscape rake from swinging side to side. An anti-sway device is a **must** if operating the landscape rake in a reverse (pushing) position.

3. Install the rake tine bar assembly to the mounting frame and retain with 1” bolt, flat washer and locknut. The locknut should be just loose enough for the rake assembly to pivot.

INSTRUCTIONS (continued)

ASSEMBLY (continued)

FOR MODEL LRHD RAKES

Place jack stands or suitable blocking under tinebar so center pivot bolt and 3 pt. mount can be installed.

Place 3 pt. frame assembly on top of the tinebar and align 1 inch pivot hole with center hole on tine bar.

Install 1 inch pivot bolt and flat washer. Tighten bolt so 3 pt. mount will swing but without excessive looseness.

Place 3 pt. frame in desired position and install angle shift pin.

Place parking stand in position to support landscape rake.

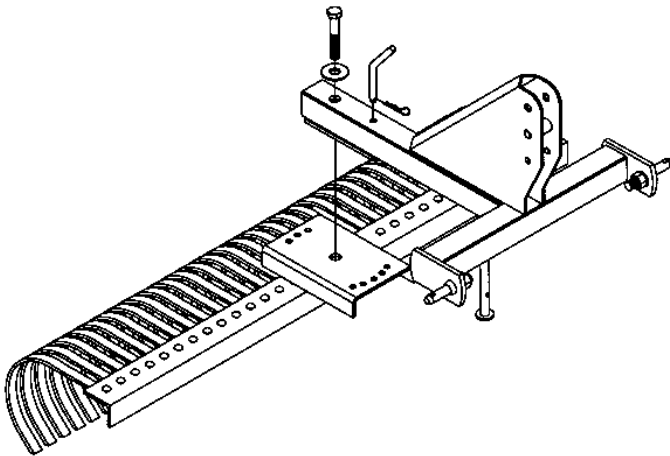

GAUGE WHEEL INSTALLATION

DUAL WHEEL PACKAGE

(Recommended for rakes above 6' in width and all MCR and LRHD Series rakes)

Refer to the parts illustration and install the gauge wheel arms approximately one foot in from each end of the rake using longer carriage bolts provided. Grease the wheels upon initial assembly.

Set up gauge wheels to the desired height using the spacers and washers provided. Lock caster wheel spindle in place with linch pin.

CONNECTING LANDSCAPE RAKE TO TRACTOR

ALL MODELS

The landscape rake is compatible with Category 1, 3 point tractors equipped with side swing-type lower lift arms and some Category 0 tractors.

1. To avoid interference with the landscape rake, adjust tractor drawbar to the shortest and highest position.
2. Attach the tractor's lower lift arms to the landscape rake and secure in place with lock pin.

For Category 0 Hitch application, order optional pull pin kit part #590331 (one pair); replace the Category 1 pins with the Category 0 pins. Make sure the Category 0 pins are on the inside.

3. Tractor must be equipped with stabilizer bars, adjustable sway chains, or sway blocks to keep the implement from swinging side to side.
4. Attach the tractor's top link to the top of the landscape rake's mast and secure with the top link pin and retaining pin supplied with the top link.

IMPORTANT

■ Make sure rake is at least 6" (15 cm) from tractor tires throughout complete range of 3 point hitch operation.

Level the A-frame and tinebar with 3 point connecting links and top link. Adjusting the top link length will change the fore and aft pitch of the teeth.

Lengthening the top link will cause the teeth to contact the ground with a sharper pitch and be more aggressive.

You may need to adjust the optional gauge wheels after adjusting pitch to maintain the desired working depth.

FOR MODEL LRHD RAKES ONLY

For Category 1 Quick Hitch application, order optional bushing kit part #862500 (one pair); place bushing over draw pin and fasten with roll pin.

For Quick Hitch application, the top center hitch hook will seat into welded 1 1/4" diameter pin. This pin does not interfere when unit is used with a standard 3 point hitch.

OPERATION

OPERATION

The operator is responsible for the safe operation of this equipment. The operator must be properly trained. Operators should be familiar with the equipment, the tractor, and all safety practices before starting operation. Read the safety rules and safety decals on page 3 through page 6.

The landscape rake is designed for a wide range of applications: loosening, leveling, and clearing soil or debris.

The rake may be angled to windrow material to the side for removal.



WARNING

Power unit must be equipped with ROPS or ROPS cab and seat belt. Keep seat belt securely fastened. Falling off power unit can result in death from being run over or crushed. Keep foldable ROPS systems in “locked up” position at all times.



WARNING

When using the rake in a reverse position, use extra care – DO NOT RAM RAKE into dirt or packed snow piles! Tractor lift arms and the rake are not built to take high impact loads in this position. RAMMING backwards can also dislodge operator from seat and/or tractor controls, resulting in possible serious injury.

GRADING

Adjust the 3 point hitch upper link so that the frame of the landscape rake is parallel with the ground. If gauge wheels are used, adjust them for the amount of cut you want to take, usually about 1". Set the rake angle adjustment as desired – straight for grading or angled for a windrowing effect. It is recommended to operate the rake at a slow speed (max. 3 mph) to give ample time for fine material to flow through the tines.

ANGLE GRADING

The rake should be angled horizontally only enough to allow the material to slide along it easily. The angle (tilt) of the rake must be set to suit conditions. This is controlled by the lift arm leveling assembly (turnbuckle) on the tractor 3 point hitch.

LEVELING

The rake should be straight across, i.e., 90° to the line of travel of the tractor, in other words 0° horizontal angle.

There should be 0° vertical angle, i.e., the lift arms on the tractor 3 point hitch should be parallel to the ground.

The use of gauge wheels will make the leveling operation much easier and improve the quality of the job.

When using the rake with gauge wheels, you may need to adjust the gauge wheels after adjusting pitch to maintain the desired working depth.

REVERSE OPERATION

Depending on the job, the angle grading or leveling position may be used. For heavy work, use a regular 3 point rear blade.

NOTE: Most rakes and blades are damaged in this position – use extra care – DO NOT RAM into obstructions (including hard packed dirt piles)!

RAKING

Vegetative trash and clods or rocks may be raked into piles or into windrows for easier pickup. DO NOT overload rake – remove large rocks, roots, or limbs by other means.

INCORPORATING SEED

Seed is best incorporated by making two passes in diagonal directions. Consult your seed supplier or reference book for the recommended seed depth. Set the rake straight and operate the rake at two times the recommended seed depth. Grass seed, for example, should be covered approximately 1/4". Operate the rake at 1/2" penetration and make two passes in diagonal directions. The use of gauge wheels will provide much better depth control and improve the quality of the job.

These suggestions are generalities; best results will be obtained after some experience.

NOTE: Do not load either end of the landscape rake heavily. Try to balance the load on both ends of the landscape rake.

OWNER SERVICE

TRANSPORTING

Pay particular close attention to the Safety Messages regarding transport. Avoid unnecessary injuries and equipment damage by exercising cautious, conscientious travel procedures.

Attaching the landscape rake to the tractor increases the overall length of the working unit. Allow additional clearance for the landscape rake to swing when turning.

Always place the rake straight across (90° to line of travel) for transport.

Raise the landscape rake as high as possible for transporting.

MAINTENANCE

The information in this section is written for operators who possess basic mechanical skills. If you need help, your dealer has trained service technicians available. For your protection, read and follow the safety information in this manual.

Inspect the landscape rake for loose, damaged or worn parts and adjust or replace if needed.

Repaint parts where paint is worn or scratched to prevent rust.

Check all bolts and nuts to be sure they are tight.

Periodically grease the gauge wheel assemblies.

REPLACING RAKE TEETH

To service the landscape rake when attached to the tractor, it must be blocked up off the ground.

1. Place two blocks under the tinebar. Lower the tinebar to rest securely on the blocks.
2. Refer to parts drawing, pages 12, 13, and 14. Remove the nuts and bolts from damaged teeth. Loosen the other bolts holding the same tooth support plate. Remove the damaged teeth.
3. Insert the new teeth and secure with the bolts and hex nuts previously removed.

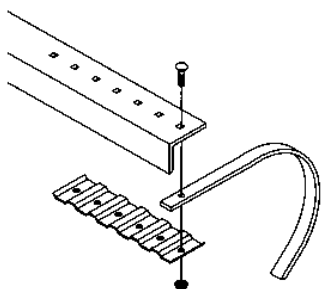

WARNING

NEVER GO UNDERNEATH EQUIPMENT. Never place any part of the body underneath equipment or between moveable parts even when the engine has been turned off. Hydraulic system leak down, hydraulic system failures, mechanical failures, or movement of control levers can cause equipment to drop or rotate unexpectedly and cause severe injury or death.

- Service work does not require going underneath.
- Read Manual for service instructions or have service performed by a qualified dealer.

WARNING

Keep all persons away from operator control area while performing adjustments, service, or maintenance.

Before dismounting power unit or performing any service or maintenance, follow these steps: disengage power to equipment, lower the 3 point hitch and all raised components to the ground, operate valve levers to release any hydraulic pressure, set parking brake, stop engine, remove key, and unfasten seat belt.

STORAGE

- At the end of the working season or when the landscape rake will not be used for a long period, it is good practice to clean off any dirt that may have accumulated.
- Inspect the landscape rake for loose, damaged or worn parts and adjust or replace if needed.
- Storage location should be level and solid to make hitching and unhitching easy.
- Always store in a safe place away from children or livestock.

TROUBLE-SHOOTING GUIDE

PROBLEM	POSSIBLE CAUSE	POSSIBLE REMEDY
Rake will not penetrate soil.	<ol style="list-style-type: none">1. Tinebar set too straight.2. Soil too hard.	<p>Increase 3 pt. hitch toplink length.</p> <p>Loosen soil with scarifiers or disk.</p> <p>Wait for rain.</p>
Rake teeth digging in too much.	<ol style="list-style-type: none">1. Tinebar pitch excessive.2. Soft ground.	<p>Adjust toplink (shorten).</p> <p>Install gauge wheels.</p> <p>Wait for dryer soil.</p>
3 Pt. hitch frame bent.	<ol style="list-style-type: none">1. Hitting hidden objects in backfill position or ramming backwards into hard piles of soil.2. Using too large of tractor.	<p>Use slow speed when in unknown soil conditions.</p> <p>Always backfill at slow speed.</p> <p>Preferably use tractor of recommended horsepower.</p> <p>Slow down and use extra care.</p>
Bent tinebar or bent teeth.	<ol style="list-style-type: none">1. Hitting hidden objects.2. Using too large of tractor or one that is heavily weighted and has four wheel drive.3. Hitting end of tinebar on stumps, concrete curb, or corner of building.	<p>Know soil conditions. Use slow speed when soil conditions unknown.</p> <p>Preferably use tractor of recommended horsepower.</p> <p>Slow down and use extra care.</p> <p>Have operator use care when driving close to obstacles.</p>
Unable to hold level grade.	<ol style="list-style-type: none">1. Tractor draft control lifting blade.2. Soil too hard.3. Uneven ground.	<p>Set tractor draft control.</p> <p>Loosen soil with scarifiers or disk.</p> <p>Install gauge wheels.</p>

MCR LANDSCAPE RAKE PARTS LIST

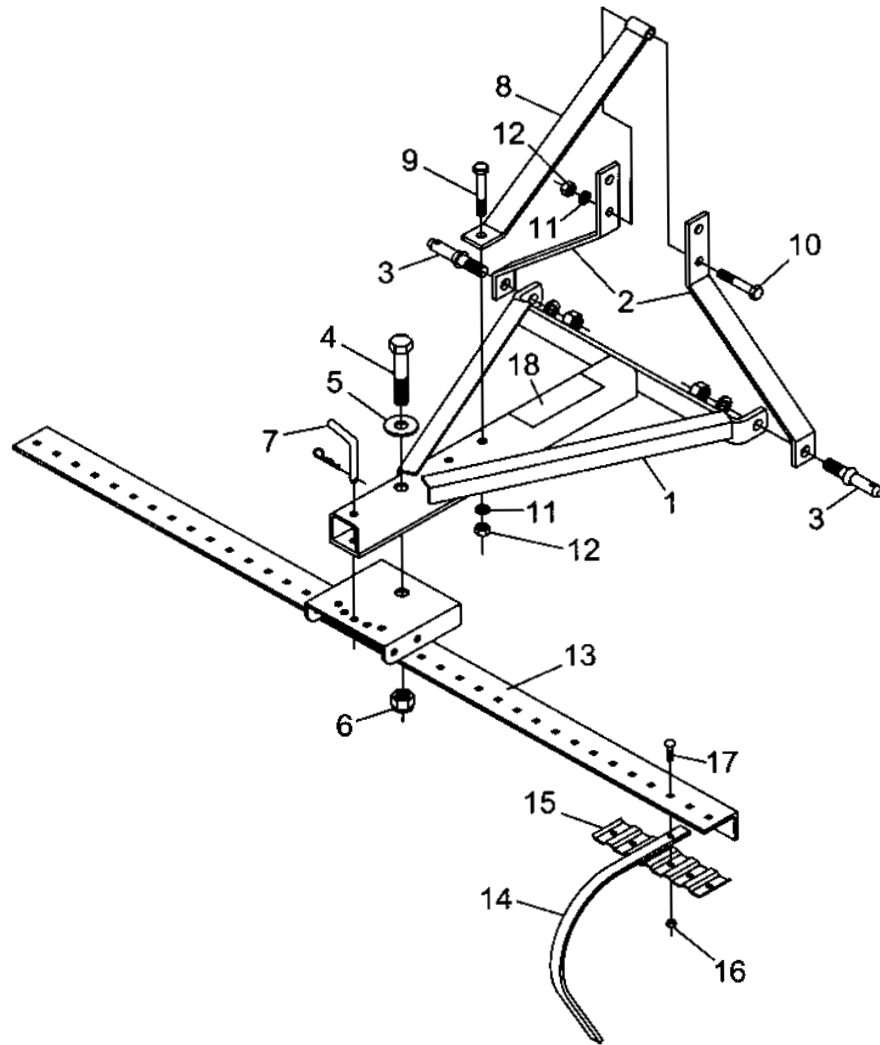

Ref. No.	Part No.	Description	No. Req'd.
1	345140	3 Pt. Mount Weldment	1
2	345147	Toplink Side Bar	2
3	590108	Draw Pin (AK-578)	2
4	2503028	Bolt 1"-8NC x 5" Hex Head Gr.2	1
5	2501001	Washer 1" Flat	1
6	2500045	Nut 1"-8NC Hex Nylock	1
7	343185	Shift Pin (1/2" x 4" w/Hair Clip Pin)	1
8	345145	Toplink Brace Weldment	1
9	2503066	Bolt 5/8"-11NC x 4" Hex Head Gr.2	1
10	2503049	Bolt 5/8"-11NC x 3 1/2" Hex Head Gr.2	1
11	2502007	Washer 5/8" Springlock	2
12	2500013	Nut 5/8"-11NC Full Hex	2
13	341901	Tinebar Weldment (MCR-6)	1
	341907	Tinebar Weldment (MCR-7)	1
14	341704	Rake Tooth (MCR-6)	36
		Rake Tooth (MCR-7)	42
15	341705	Tooth Support (MCR-6)	6
		Tooth Support (MCR-7)	7
16	2500081	Nut 3/8"-16NC Hex Whiz Flange (MCR-6)	36
		Nut 3/8"-16NC Hex Whiz Flange (MCR-7)	42
17	2503103	Bolt 3/8"-16NC x 1 1/2" Carriage Head Gr.2 (MCR-6)	36
		Bolt 3/8"-16NC x 1 1/2" Carriage Head Gr.2 (MCR-7)	42
18	101148	Safety Sign - Caution (Safe Operation)	1

LRHD LANDSCAPE RAKE PARTS LIST

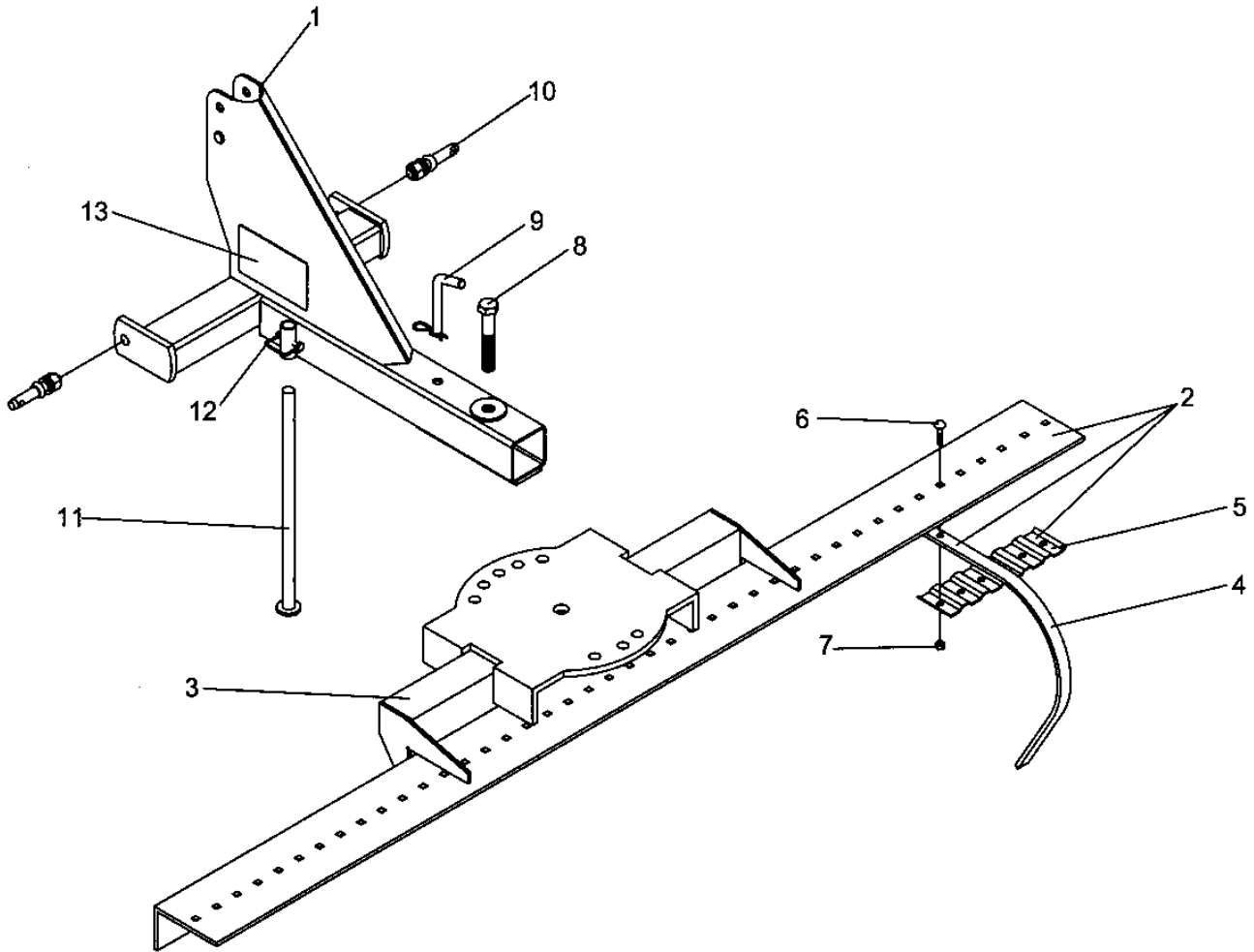

Ref. No.	Part No.	Description	No. Req'd.
1	343510	Mount, 3 Pt. Weldment	1
2	343625	LRHD-6 Tinebar Assembly	1
	343635	LRHD-7 Tinebar Assembly	1
	343645	LRHD-8 Tinebar Assembly	1
3	343626	LRHD-6 Tinebar Weldment	1
	343636	LRHD-7 Tinebar Weldment	1
	343646	LRHD-8 Tinebar Weldment	1
4	341704	Rake Tooth	Var.
5	341705	Tooth Support	Var.
6	2503103	Bolt, Carriage 3/8"-16NC x 1 1/2" Gr.2	Var.
7	2500081	Nut, Hex 3/8"-16NC Whiz Flange	Var.
8	2503312	Bolt, Hex 1"-8NC x 10" Gr.8	1
9	350030	Adjustment Pin	1
10	590108	Draw Pin (AK-578)	2
11	343571	Stand Tube Weldment	1
12	590194	Lock Pin 5/16" (AK-2907)	1
13	101148	Safety Sign - Caution (Safe Operating)	1

DGW-20 GAUGE WHEEL PARTS LIST (OPTIONAL)

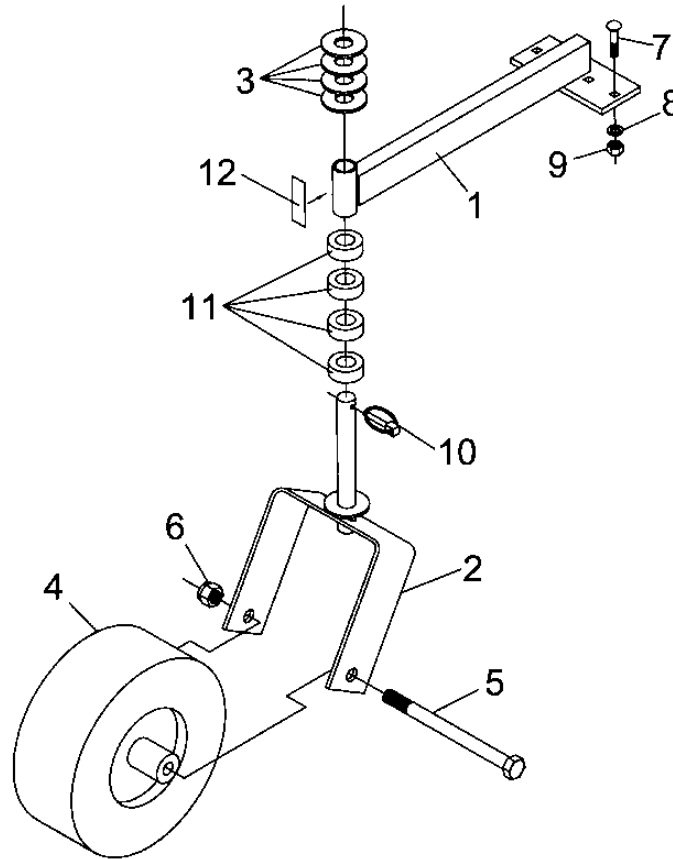

Ref. No.	Part No.	Description	No. Req'd.
	341775	Optional Gauge Wheel Kit (Pair)	1
	341749	Gauge Wheel Assembly (One Wheel)	2
1	341778	Wheel Support Arm	2
2	341779	Wheel Mount Weldment	2
3	2501001	Washer 1" Flat	8
4	341772	Wheel Assembly (13.00 x 5.00)	2
5	2503188	Bolt 3/4" - 10NC x 9 1/2" Hex Head Gr.2	2
6	2500037	Nut 3/4" - 10NC Hex Nylock	2
7	2503189	Bolt 3/8" - 16NC x 2" Carriage Head Gr.2	8
8	2502008	Washer 3/8" Springlock	8
9	2500004	Nut 3/8" - 16NC Full Hex	8
10	590034	Linch Pin 1/4" (AK-61)	2
11	650974	Height Adjustment Bushing	8
12	101262	Red Reflective Tape (1" x 3")	2

SAFETY REQUIREMENTS

AVOID ACCIDENTS BY FOLLOWING ALL OF THE SAFETY REQUIREMENTS LISTED BELOW.

- Machinery should be operated only by those who are responsible and are authorized to do so.
- Stop the engine, lower all equipment, lock the brakes, and remove the ignition key before dismounting from the tractor.
- Never stand between tractor and implement while tractor is being backed to hitch.
- Loose fitting clothing should not be worn, to avoid catching on various parts.
- Detach implement in area where children normally do not play.
- When performing adjustments or maintenance on an implement, first lower it to the ground or block it securely at a workable height.
- Only a qualified operator should be permitted on tractor when in operation; no riders allowed.
- Make certain everyone is in the clear before starting tractor or raising or lowering equipment.
- Operate the tractor and implement only while seated in the driver's seat.
- Reduce speed when transporting mounted implements to avoid bouncing and momentary loss of steering control.
- A heavy load can cause instability of the tractor. Use extreme care during road travel. Slow down on turns and watch out for bumps. Tractor may need front counterweights to counter-balance the weight of the implement.
- Reduce speed on hillsides or curves so there is no danger of tipping.
- Avoid driving too close to the edge of ditches or creeks.
- Do not transport implement on public roads without reflectors and slow moving vehicle emblem in daylight and with approved warning lights at night and other periods of poor visibility.
- Due to the width of some implements, use extra caution on highways, farm roads, and when approaching gates.
- Always be sure the implement is in the proper position for transport.
- Keep alert and watch the front as well as the rear when working with the implement.

OWNER'S/ OPERATOR'S MANUAL

MODEL NO.'s

MCR-6

MCR-7

LRHD-6

LRHD-7

LRHD-8

MAY 2019

3 PT. LANDSCAPE RAKE

MCR Series – Cat. I – up to 40 hp

LRHD Series – Cat. I – up to 50 hp

**WHEN ORDERING REPAIR PARTS,
ALWAYS GIVE THE FOLLOWING INFORMATION:**

1. PART NUMBER
2. PART DESCRIPTION
3. MODEL NUMBER
4. NAME OF ITEM

**MAKE EVERY DAY
A HOLIDAY FROM ACCIDENTS**

WORKSAVER, INC.

P.O. BOX 100 LITCHFIELD, IL 62056-0100 (217) 324-5973
WEB: <http://www.worksaver.com> E-MAIL: sales@worksaver.com