

**OWNER'S/  
OPERATOR'S  
MANUAL**

**MODEL NO.  
SSGB-8B**

**⚠ CAUTION**

For Safe Operation  
Read Rules And  
Instructions Carefully

SINO LEEINGLES, PIDA AYUDA  
A AIGUIEN QUE SI LO LEA  
PARA QUE LE TRADUZCA LAS  
MEDIDAS DE SEGURIDAD.

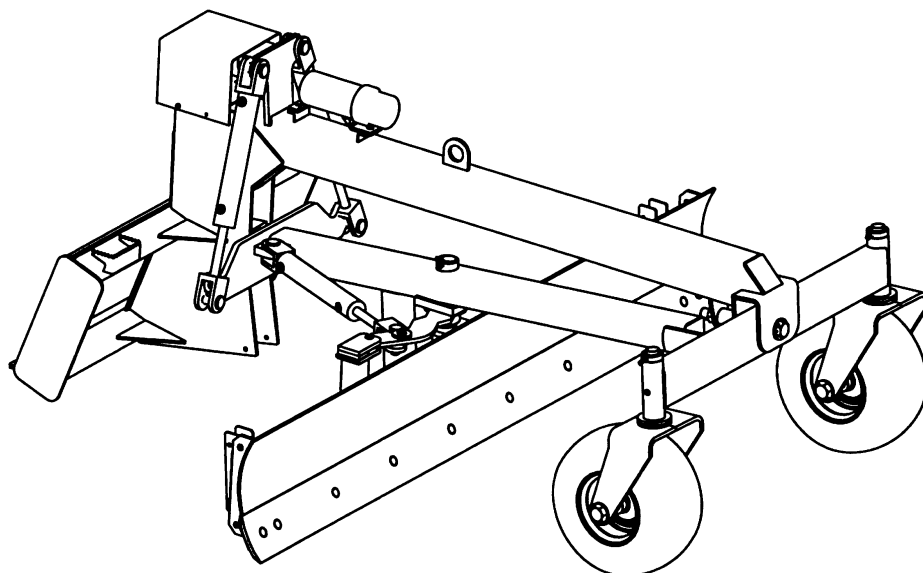

**SKID STEER MOUNTED  
GRADER BLADE**

**Safety Instructions  
Tractor Preparation  
Operating Instructions**

**Assembly & Mounting  
Maintenance  
Repair Parts**

**⚠ CAUTION ⚠**

**THE FOLLOWING SAFETY PRECAUTIONS SHOULD BE THOROUGHLY UNDERSTOOD  
BEFORE ATTEMPTING TO BEGIN ASSEMBLING THIS MACHINE**

1. Select an area for assembly that is clean and free of any debris which might cause persons working on the assembly to trip.
2. Do not lift heavy parts or assemblies. Use crane, jack, tackle, fork trucks or other mechanical devices.
3. Preview the assembly instructions in your operator's manual before proceeding further.
4. If the assembly instructions call for parts or assemblies to be blocked up, use only blocking material that is in good condition and is capable of handling the weight of the assembly to be blocked. Also insure that the blocking material is on a clean, dry surface.
5. Never put hands, or any part of body, under blocked up assemblies if at all possible.
6. After completing assembly, thoroughly inspect the machine to be sure that all nuts, bolts, hydraulic fittings or any other fastened assemblies have been thoroughly tightened.
7. Before operating the machine, thoroughly read the operation section of your operator's manual.
8. Before operating, read the maintenance section of your operator's manual to be sure that any parts requiring lubrication, such as gearboxes, are full, to avoid any possible damage.
9. **Before operating equipment – If you have any questions regarding the proper assembly or operation, contact your dealer or representative.**



# TABLE OF CONTENTS

WARRANTY .....	2
SAFETY INFORMATION .....	3
SAFETY SIGNS .....	11 - 12
PREPARATION INSTRUCTIONS .....	13 - 14
OPERATING INSTRUCTIONS .....	15 - 16
SERVICE & MAINTENANCE .....	17 - 18
TROUBLE-SHOOTING .....	19 - 20
PARTS LISTS .....	21 - 24
WIRING & ELECTRICAL SCHEMATIC .....	25 - 26
END PLATE OPTION .....	27
LASER POLE OPTION .....	28
SPECIFICATIONS .....	29
BOLT TORQUE CHART .....	30

SINO LEEINGLES, PIDA AYUDA A AIGUIEN QUE SI LO LEA PARA QUE LE TRADUZCA LAS MEDIDAS DE SEGURIDAD.

## STATEMENT OF POLICY

It is the policy of Worksaver, Inc. to improve its products where it is possible and practical to do so. Worksaver, Inc. reserves the right to make changes or improvements in design and construction at any time, without incurring the obligation to make these changes on previously manufactured units.

## TO THE OWNER:

Read this manual before using your Grader Blade. This manual is provided to give you the necessary operating and maintenance instructions for keeping your Grader Blade in top operating condition. Please read this manual thoroughly. Understand what each control is for and how to use it. Observe all safety signs on the machine and noted throughout the manual for safe operation of implement. Keep this manual handy for ready reference.

Like all mechanical products, it will require cleaning and upkeep. Lubricate the Grader Blade as specified.

Use only genuine Worksaver, Inc. service parts. Substitute parts will void the warranty and may not meet standards required for safe and satisfactory operation. Record the model and serial number of your Grader Blade here:

Model: \_\_\_\_\_ Serial Number: \_\_\_\_\_

## RETAIL CUSTOMER'S RESPONSIBILITY

**It is the Retail Customer and/or Operator's responsibility to read the Operator's Manual, to operate, lubricate, maintain, and store the product in accordance with all instructions and safety procedures. Failure of the operator to read the Operator's Manual is a misuse of this equipment.**

**It is the Retail Customer and/or Operator's responsibility to inspect the product and to have any part(s) repaired or replaced when continued operation would cause damage or excessive wear to other parts or cause a safety hazard.**

**It is the Retail Customer's responsibility to deliver the product to the authorized Worksaver Dealer, from whom he purchased it, for service or replacement of defective parts which are covered by warranty. Repairs to be submitted for warranty consideration must be made within forty-five (45) days of failure.**

**It is the Retail Customer's responsibility for any cost incurred by the Dealer for traveling to or hauling of the product for the purpose of performing a warranty obligation or inspection.**

# LIMITED WARRANTY

Worksaver warrants to the original purchaser of any new Grader Blade Model SSGB-8B, that the equipment be free from defects in material and workmanship for a period of TWELVE (12) MONTHS COMMENCING ON THE DATE OF DELIVERY OF THE PRODUCT TO THE ORIGINAL PURCHASER. This warranty will apply if notified to Worksaver, Inc. within thirty (30) days after such defect is discovered.

The warranty registration must be completed and returned to Worksaver, Inc.

Replacement or repair parts installed in the equipment covered by this warranty are warranted for ninety (90) days from the date of purchase of such part or to the expiration of the applicable new equipment warranty period, whichever occurs later.

Such parts shall be provided at no cost to the user during regular working hours. Worksaver reserves the right to inspect any equipment or parts which are claimed to have been defective in material or workmanship.

This warranty is extended solely to the original purchaser of the product. Should the original purchaser sell or otherwise transfer this product to a third party, this warranty does not transfer to the third party purchaser in any way. There are no third party beneficiaries of this warranty.

## DISCLAIMER OF IMPLIED WARRANTIES & CONSEQUENTIAL DAMAGES

Worksaver shall not be liable for any incident or consequential losses, damages or expenses, arising directly or indirectly from the product, whether such claim is based upon breach of contract, breach of warranty, negligence, strict liability in tort or any other legal theory.

Worksaver's obligation under this warranty, to the extent allowed by law, is in lieu of all warranties, implied or expressed, including implied warranties of merchantability and fitness for a particular purpose and any liability for incidental and consequential damages with respect to the sale or use of the items warranted. Such incidental and consequential damages shall include but not be limited to: transportation charges other than normal freight charges; cost of installation other than cost approved by Worksaver; duty; taxes; charges for normal service or adjustments; loss of crops or any other loss of income; rental of substitute equipment, expenses due to loss, damage, detention or delay in the delivery of equipment or parts resulting from acts beyond the control of Worksaver.

## THIS WARRANTY SHALL NOT APPLY:

1. To vendor items which carry their own warranties, such as hydraulic cylinders, tires, and laser control systems.
2. If the unit has been subjected to misapplication, abuse, misuse, negligence, fire or other accident.
3. If parts not made or supplied by Worksaver have been used in connection with the unit, if, in sole judgement of Worksaver such use affects its performance, stability, or reliability.
4. If the unit has been altered or repaired outside of an authorized Worksaver dealership in a manner which, in the sole judgement of Worksaver affects its performance, stability or reliability.
5. To normal maintenance service and normal replacement items such as gearbox lubricant, hydraulic fluid, worn blades, or to normal deterioration of such things as hoses and exterior finish, due to use or exposure.
6. To expendable or wear items such as cutting edge, plow bolts, springs and other items that in the company's sole judgement is a wear item.

NO EMPLOYEE OR REPRESENTATIVE OF WORKSAVER IS AUTHORIZED TO CHANGE THIS WARRANTY IN ANY WAY OR GRANT ANY OTHER WARRANTY UNLESS SUCH CHANGE IS MADE IN WRITING AND SIGNED BY WORKSAVER'S SERVICE MANAGER, POST OFFICE BOX 100, LITCHFIELD, ILLINOIS 62056-0100.

**This warranty is subject to the warranty registration being submitted within sixty (60) days after purchase.** For warranty services, contact your selling dealer.

# To the Owner/Operator/Dealer

All implements with moving parts are potentially hazardous. There is no substitute for a cautious, safe-minded operator who recognizes the potential hazards and follows reasonable safety practices. The manufacturer has designed this implement to be used with all its safety equipment properly attached to minimize the chance of accidents.

## BEFORE YOU START!!

**Read the safety messages on the implement and shown in your manual.  
Observe the rules of safety and common sense!**



### THIS SYMBOL MEANS

- ATTENTION!
- BECOME ALERT!
- YOUR SAFETY IS INVOLVED!

THIS SAFETY ALERT SYMBOL IDENTIFIES IMPORTANT SAFETY WARNING MESSAGES. CAREFULLY READ EACH WARNING MESSAGE THAT FOLLOWS. FAILURE TO UNDERSTAND AND OBEY A SAFETY WARNING, OR RECOGNIZE A SAFETY HAZARD, COULD RESULT IN AN INJURY OR DEATH TO YOU OR OTHERS AROUND YOU. THE OPERATOR IS ULTIMATELY RESPONSIBLE FOR THE SAFETY OF HIMSELF, AS WELL AS OTHERS, IN THE OPERATING AREA OF THE SKID STEER AND ATTACHED EQUIPMENT.

---

## UNDERSTAND SIGNAL WORDS

Note the use of the signal words **DANGER**, **WARNING** and **CAUTION** with the safety messages. The appropriate signal word for each has been selected using the following guidelines:

**DANGER:** Indicates an imminently hazardous situation that, if not avoided, will result in death or serious injury. This signal word is to be limited to the most extreme situations typically for machine components which, for functional purposes, cannot be guarded.

**WARNING:** Indicates a potentially hazardous situation that, if not avoided, could result in death or serious injury, and includes hazards that are exposed when guards are removed. It may also be used to alert against unsafe practices.

**CAUTION:** Indicates a potentially hazardous situation that, if not avoided, may result in minor or moderate injury. It may also be used to alert against unsafe practices.

If you have questions not answered in this manual or require additional copies or the manual is damaged, please contact your dealer or the manufacturer directly.

---

## IMPORTANT SAFETY INFORMATION!

Working with unfamiliar equipment can lead to careless injuries. Read this manual, and the manual for your tractor, before assembly or operating, to acquaint yourself with the machines. It is the implement owner's responsibility, if this machine is used by any person other than yourself, is loaned or rented, to make certain that the operator, prior to operating:

1. Reads and understands the operator's manuals.
2. Is instructed in safe and proper use.













The use of this equipment is subject to certain hazards which cannot be protected against by mechanical means or product design. All operators of this equipment must read and understand this entire manual, paying particular attention to safety and operating instructions, prior to using. If there is something in this manual you do not understand, ask your supervisor, or your dealer, to explain it to you.

# SAFETY INSTRUCTIONS (continued)



## EQUIPMENT SAFETY GUIDELINES

-  Safety of the operator is one of the main concerns in designing and developing a new piece of equipment. Designers and manufacturers build in as many safety features as possible. However, every year many accidents occur which could have been avoided by a few seconds of thought and a more careful approach to handling equipment. You, the operator, can avoid many accidents by observing the following precautions in this section. To avoid personal injury, study the following precautions and insist those working with you, or for you, follow them.
  
-  In order to provide a better view, certain photographs or illustrations in this manual may show an assembly with a safety shield removed. However, equipment should never be operated in this condition. Keep all shields in place. If shield removal becomes necessary for repairs, replace the shield prior to use.
  
-  Replace any CAUTION, WARNING, DANGER or instruction safety sign that is not readable or is missing. Location of such safety signs is indicated in this booklet.
  
-  Never use alcoholic beverages or drugs which can hinder alertness or coordination while operating this equipment. Consult your doctor about operating this machine while taking prescription medications.
  
-  Review the safety instructions with all users annually.
  
-  This equipment is dangerous to children and persons unfamiliar with its operation. The operator should be a responsible adult familiar with farm machinery and trained in this equipment's operations. **Do not allow persons to operate or assemble this unit until they have read this manual and have developed a thorough understanding of the safety precautions and of how it works.**
  
-  Do not paint over, remove or deface any safety signs or warning signs on your equipment. Observe all safety signs and practice the instruction on them.
  
-  Never exceed the limits of a piece of machinery. If its ability to do a job, or to do so safely, is in question – **DON'T TRY IT.**
  
-  Do not modify the equipment in any way. Unauthorized modification may impair the function and/or safety and could affect the life of the equipment.
  
-  In addition to the design and configuration of this implement, including Safety Signs and Safety Equipment, hazard control and accident prevention are dependent upon the awareness, concern, prudence, and proper training of personnel involved in the operation, transport, maintenance, and storage of the machine. Refer also to Safety Messages and Operation Instructions in each of the appropriate sections of the Skid Steer and Attachment Manuals. Pay close attention to the Safety Signs affixed to the Skid Steer and the Attachment.

# SAFETY INSTRUCTIONS (continued)



## SAFETY SIGNS



Keep safety signs clean and legible at all times.



Replace safety signs that are missing or have become illegible.



Replaced parts that displayed a safety sign should also display the current sign.



Safety signs are available from your Distributor or Dealer Parts Department or the factory.

### **How to Install Safety Signs:**



Be sure that the installation area is clean and dry. Be sure temperature is above 50°F (10°C).



Decide on the exact position before you remove the backing paper.



Remove the smallest portion of the split backing paper. Align the sign over the specified area and carefully press the small portion with the exposed sticky backing in place.



Slowly peel back the remaining paper and carefully smooth the remaining portion of the sign in place. Small air pockets can be pierced with a pin and smoothed out using the piece of sign backing paper.



## SAFETY TRAINING



Safety is a primary concern in the design and manufacture of our products. Unfortunately, our efforts to provide safe equipment can be wiped out by a single careless act of an operator. It is the operator's responsibility to read and understand ALL Safety and Operating instructions in the manual and to follow these. Accidents can be avoided.

In addition to the design and configuration of equipment, hazard control and accident prevention are dependent upon the awareness, concern, prudence and proper training of personnel involved in the operation, transport, maintenance and storage of equipment.



Working with unfamiliar equipment can lead to careless injuries. Read this manual, and the manual for your skid steer, before assembly or operating, to acquaint yourself with the machines. It is the owner's responsibility, if this machine is used by any person other than yourself, is loaned or rented, to make certain that the operator, prior to operating:

1. Reads and understands the operator's manuals.
2. Is instructed in safe and proper use.



Know your controls and how to stop skid steer, engine, and attachment quickly in an emergency. Read this manual and the one provided with your skid steer.



Train all new personnel and review instructions frequently with existing workers. A person who has not read and understood all operating and safety instructions is not qualified to operate the machine. An untrained operator exposes himself and bystanders to possible serious injury or death.







Do not allow children to operate this machine.

# SAFETY INSTRUCTIONS (continued)









## STARTING AND STOPPING SAFETY

-  Be certain the skid steer is in neutral or park position before starting engine.
-  Do not leave the skid steer or the attachment unattended with the engine running.
-  Grader blade operating power is supplied from skid steer hydraulic system. Refer to your skid steer manual for hydraulic engagement and disengagement instructions. Know how to stop skid steer and grader controls quickly in case of an emergency.
-  Grader blade should be on the ground before engaging hydraulic power and be sure that no one is near the machine. When engaging hydraulic system, the RPM should always be low.
-  Take all possible precautions when leaving unit unattended: Disengage hydraulic power, set parking brake, stop engine and remove key from ignition. Park in level area.



## OPERATIONAL SAFETY

-  The use of this equipment is subject to certain hazards which cannot be protected against by mechanical means or product design. All operators of this equipment must read and understand this entire manual, paying particular attention to safety and operating instructions, prior to using. If there is something in this manual you do not understand, ask your supervisor, or your dealer, to explain it to you.
-  Most accidents occur because of neglect or carelessness. Keep all helpers and bystanders at least twenty (20) feet from an operating grader. Only properly trained people should operate this machine.
-  Avoid uneven and rough terrain. DO NOT operate near drop off, ditches, or embankments. Unit can suddenly turn over if a wheel is over the edge of a cliff or ditch, or if an edge caves in.
-  Do not walk or work under a raised skid steer attachment unless it is securely blocked or held in position. Do not depend on the hydraulic system to hold the skid steer attachment in place.
-  A heavy load can cause instability of the skid steer. Use extreme care during travel. Slow down on turns and watch out for bumps. The skid steer may need additional counter-weights to counter-balance the weight of the grader blade attachment.
-  Never use alcoholic beverages or drugs which can hinder alertness or coordination while operating this equipment. Consult your doctor about operating this machine while taking prescription medications.
-  Never permit any person other than the operator to ride or board the skid steer or grader blade attachment at any time. ALLOW NO RIDERS!



# SAFETY INSTRUCTIONS (continued)



## OPERATIONAL SAFETY (continued)



Before you operate the grader blade, check over all pins, bolts and connections to be sure all are securely in place. Replace any damaged or worn parts immediately.



Consult local utility companies to make certain there are no buried gas lines, electrical cables, etc., in the work area before beginning operation.



Use extreme care and maintain minimum ground speed when transporting on hillside, over rough ground and when operating close to ditches or fences. Be careful when turning sharp corners.



Avoid sudden starts and stops while traveling up or downhill. Avoid parking on a slope.



Always drive down slopes; never across the face. Avoid operation on steep slopes. Slow down on sharp turns and slopes to prevent tipping and/or loss of control. Avoid slopes when surface is wet, slippery grass or soil. Be careful when changing directions on slopes. Do not start or stop suddenly on slopes.



Keep work area clear of all debris. Debris could damage the unit. Never assume an area is clear. ALWAYS CHECK.



Inspect the entire machine periodically as indicated in the Maintenance Section of this manual. Look for loose fasteners, worn or broken parts and/or shields. Make sure all pins have cotter pins and washers. Serious injury may occur from not maintaining this machine in good working order.



Most accidents occur because of neglect or carelessness. Keep all helpers and bystanders at a safe distance. Make sure children are out of work area and under watchful care of a responsible adult.



Beware of low electrical wires if grader blade attachment is raised with skid steer loader. Serious injury or death can result if contact is made. Beware of lift clearance when raising grader blade to maximum height.



Keep alert and watch the rear as well as the front when working with the grader blade. Watch for traffic when operating along streets or curbs.













When maneuvering close to buildings or passing through narrow areas, be sure to allow sufficient clearance for the skid steer and attachment. Drive slowly.

# SAFETY INSTRUCTIONS (continued)



## OPERATIONAL SAFETY (continued)

-  Operate grader blade from operator's seat only. Remain at controls until operating cycle is complete.
  
-  Stop skid steer loader gradually when lowering or lifting loads. Operate skid steer and grader blade controls smoothly, avoid jerky operation.
  
-  Allow for additional length of loader arms and attachment on skid steer while turning.
  
-  Be sure that people, livestock, or pets are not standing near the machine while operating.
  
-  Avoid excessive speed during operation.
  
-  Do not lift or carry anyone on loader or in bucket or on attachment. Do not use grader blade for a work platform.
  
-  ALWAYS lower loader and grader blade attachment to the ground or block securely before performing any maintenance work.
  
-  Stay alert for holes, rocks and roots in the terrain and other hidden hazards. Keep away from drop-offs.
  
-  Use extra care when loading or unloading grader blade onto trailer or truck. NEVER secure rods or linkages on unit that could be damaged when transporting.
  
-  Before operating equipment: if you have any questions regarding the proper assembly or operation, contact your dealer or representative.

# SAFETY INSTRUCTIONS (continued)



## MAINTENANCE SAFETY



Before working on this machine, drive to a level area, relieve hydraulic pressure, lower implement (or if working underneath, raise and block securely), shut off the engine, set the brakes, and remove the ignition keys. Relieve hydraulic pressure prior to doing any maintenance.



Never work under equipment unless it is blocked securely. Never depend on hydraulic system to keep implement in raised position.



Keep all persons away from operator control area while performing adjustments, service, or maintenance.



Make sure there is plenty of ventilation. Never operate the engine of the vehicle in a closed building. The exhaust fumes may cause asphyxiation.



Always use personal protection devices such as eye, hand and hearing protectors, when performing any service or maintenance.



Never use your hands to locate a hydraulic leak on attachments. Use a small piece of cardboard or wood. Hydraulic fluid escaping under pressure can penetrate the skin.

Openings in the skin and minor cuts are susceptible to infection from hydraulic fluid. If injured by escaping hydraulic fluid, see a doctor at once. Gangrene and death can result. Without immediate medical treatment, serious infection and reactions can occur.



Periodically tighten all bolts, nuts and screws and check that all cotter pins are properly installed to ensure unit is in a safe condition.



When completing a maintenance or service function, make sure all safety shields and devices are installed before placing unit in service.



Always use two people to handle heavy, unwieldy components during assembly, installation, removal, or moving the grader blade attachment













Check to ensure all safety signs are installed and in good condition. (See safety sign section for location drawing.)

**Good maintenance is your responsibility. Poor maintenance is an invitation to trouble.**

# SAFETY INSTRUCTIONS (continued)





## TRANSPORT SAFETY

-  Comply with state and local laws governing highway safety and movement of machinery on public roads.
-  The use of flashing amber lights is acceptable in most localities. However, some localities prohibit their use. Local laws should be checked for all highway lighting and marking requirements.
-  Always be sure the attachment is in the proper raised position for transport.
-  If grader unit is loaded on a truck or trailer for transport, make sure unit is securely tied down. NEVER tie to rods or linkage parts that could be damaged.
-  Reduce speed when transporting mounted attachments to avoid bouncing and momentary loss of steering control.
-  Plan your route to avoid heavy traffic.
-  Do not drink and drive!
-  Watch for traffic when operating near or crossing roadways.
-  Never allow riders on either skid steer or attachment. Falling off can kill.
-  Be a safe and courteous driver. Always yield to oncoming traffic in all situations, including narrow bridges, intersections, etc.



## STORAGE SAFETY

-  Store the unit in an area away from human activity. Do not permit children to play on or around the stored unit.
-  Make sure all parked machines are on a hard, level surface and engage all safety devices. Storage location should be level and solid to make connecting and unconnecting to skid steer easy.
-  If blocking is used, make sure it is solid and secure before leaving area.

# SAFETY SIGNS

**⚠ WARNING**

TO AVOID SERIOUS INJURY OR DEATH:

- Read Operator's Manual before operating, servicing or repairing equipment. Follow all safety rules and instructions. (Manuals are available from your selling dealer.)
- Never allow riders.
- Keep bystanders away from equipment during operation.
- Operate from operator's seat only.
- Keep all shields in place and in good condition.
- Lower equipment to ground, stop engine, remove key and set brake before dismounting power unit.
- Never allow children or untrained persons to operate equipment.

FAILURE TO FOLLOW THESE INSTRUCTIONS CAN RESULT IN INJURY OR DEATH.

101289

**⚠ WARNING**

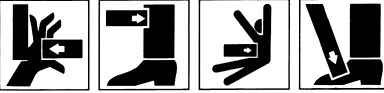

**CRUSHING AND PINCHING HAZARD**

- Be extremely careful with various parts of the machine. Pivoting blade can crush or pinch body parts.
- Operate controls from operator's seat only.
- Make sure parking brake is engaged before leaving operator's seat.
- Stand clear of machine while in operation or when it is being raised or lowered.

FAILURE TO FOLLOW THESE INSTRUCTIONS COULD RESULT IN SERIOUS INJURY OR DEATH.

101288

**⚠ WARNING**



**HIGH-PRESSURE FLUID HAZARD**

To prevent serious injury or death:

- Relieve pressure on system before repairing or adjusting or disconnecting.
- Wear proper hand and eye protection when searching for leaks. Use wood or cardboard instead of hands.
- Keep all components in good repair.

700



**⚠ CAUTION**

**NO STEP**

Enter from right side

**⚠ WARNING**

**Stand clear**

101027

**⚠ CAUTION**

When getting on and off unit:

- Always face unit.
- Use hand holds on skid steer and steps with at least three points of support.
- Always mount and dismount from this side.

101290

REMEMBER: If Safety Signs have been damaged, removed, become illegible or parts replaced without Signs, new Safety Signs must be applied. New Safety Signs are available from your authorized distributor or factory.

# SAFETY SIGN LOCATION

The types of safety signs and locations on the equipment are shown in the illustration below. Good safety requires that you familiarize yourself with various safety signs, the type of warning and the area, or particular function related to that area, that requires your SAFETY AWARENESS.

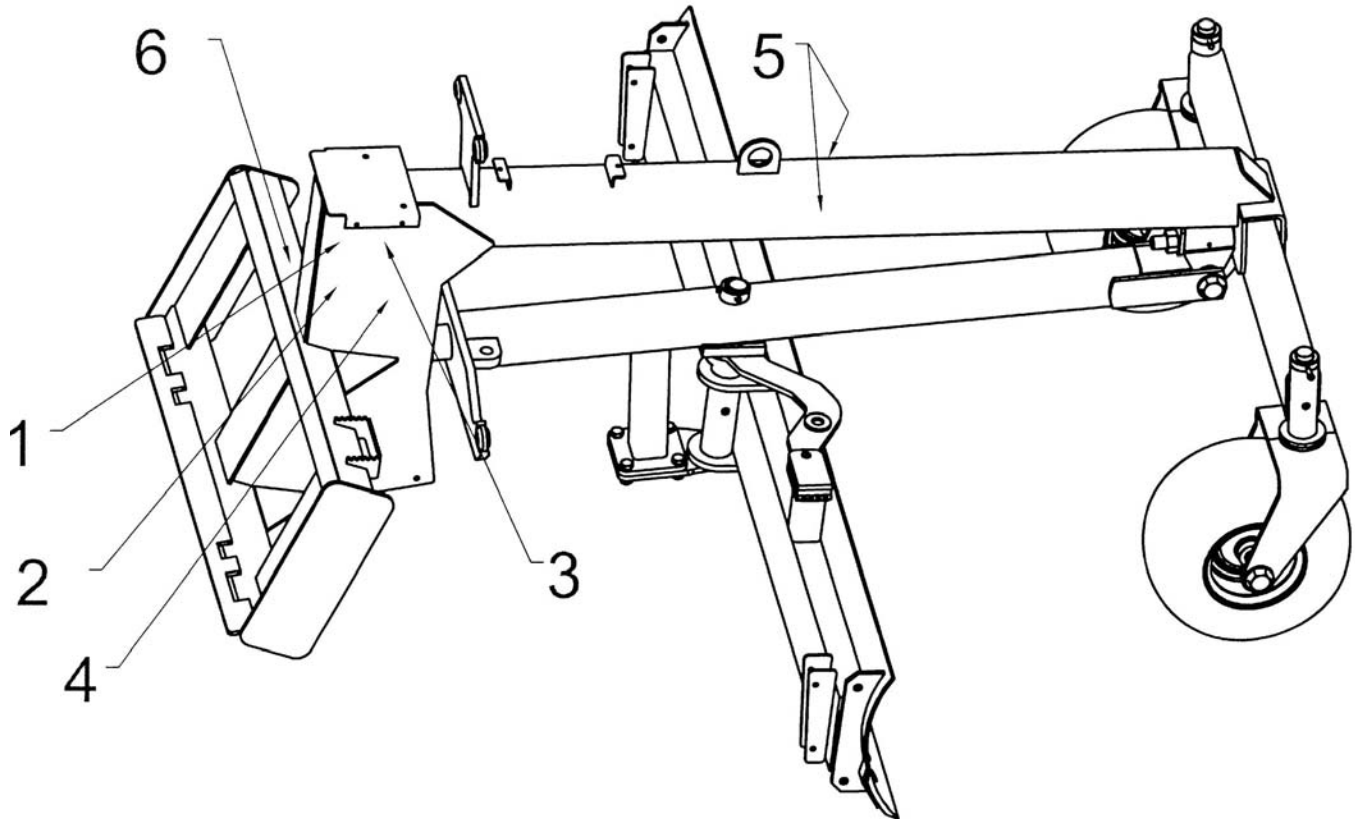

Ref. No.	Part No.	Description	No. Req'd.
1	101289	Safety Sign – Warning (Avoid Serious Injury)	1
2	101290	Safety Sign – Caution (Getting On and Off)	1
3	101288	Safety Sign – Warning (Crushing and Pinching)	1
4	101122	Safety Sign – Warning (High-Pressure Fluid)	1
5	101027	Safety Sign – Warning (Stand Clear)	2
6	101291	Safety Sign – Caution (No Step)	1

The model and serial number plate is located on the right side of the vertical part of the main frame.

The serial number is also stamped into the top cross tube of the skid steer mounting frame.

# INSTRUCTIONS

---

## SKID STEER REQUIREMENTS AND PREPARATION

---

The Model SSGB-8B Grader Blade is designed to fit skid steer units with the “Universal” style quick-attach loaders.

Remove the bucket from your Skid Steer unit. Check the loader arms and cylinders to make sure they are in good working order. Lubricate all loader pivot points. Check all bolts to make sure they are in place and tight.

Be sure the skid steer hydraulic oil and filter have been serviced according to the skid steer manufacturer’s recommendations.



**Be sure your skid steer is in good condition. Read all the safety precautions and make sure all skid steer operators are familiar with the safety rules of operation.**

Check the skid steer tires. The rear tires are used to operate the skid steer with the grader blade attachment and should have good tread. Adjust tire pressure to 50 psi (346 KN/m<sup>2</sup>). Keep tire valves capped.

If an optional laser control is used, see manual provided with laser unit for installation and operating instructions.

**NOTE:** Read section on hydraulic valve – page 16.

## ASSEMBLY

---

This unit is shipped almost completely assembled. Carefully follow instructions for final assembly.

Before attempting assembly check the following items. Having all the needed parts and equipment readily at hand will speed up your assembly task and will make the job as safe as possible.

- Check for fasteners and pins that were shipped with the grader blade. All hardware coming from the factory has been installed in the location where it will be used. If a part or fastener is temporarily removed for assembly reasons, remember where it goes. Keep the parts separated.
- Have a minimum of 2 people at hand during assembly.

Refer to the “exploded view” of the skid steer mounted grader blade on page 22 of this manual. Become familiar with the relationship of the various components and parts shown.

The caster wheel assemblies have been removed for shipping. Clean the vertical caster fork spindles and smear grease on the spindles before assembly. Fasten with the lock collar and make sure set screw bolt goes into countersunk hole in spindle. Then connect grease gun to grease zerk and apply until excess grease appears.

The hydraulic cylinder has been disconnected from the blade to allow a narrow shipping profile.

After the grader blade is attached to the skid steer, manually position the blade so the pin can connect the cylinder rod end to the shearpin arm of the blade.

## GRADER INSTALLATION / REMOVAL

---

### To install:

1. Read and understand skid steer manufacturer’s instructions for installing attachments.
2. Make sure attachment pins are in “unlock” position in skid steer mounting plate.
3. Line up skid steer and grader on level ground.
4. Tilt skid steer attachment mounting plate to fit grader mounting plate.
5. Move skid steer forward and raise skid steer mounting plate until it meets grader mounting plate with skid steer mounting plate tilted slightly forward.
6. Raise skid steer mounting plate until the grader blade leaves the ground.
7. Tilt skid steer mounting plate back to secure grader mounting plate.
8. Turn off skid steer and make sure auxiliary hydraulic controls are off (see skid steer manual).
9. Lock grader to skid steer. Flip the spring loaded latch pins to the “latch lock” position and check to see they are properly latched.

# INSTRUCTIONS (continued)

## GRADER INSTALLATION / REMOVAL (continued)

10. Attach the grader hydraulic hose with the female connector to the skid steer auxiliary hydraulic hose with male connector.

**IMPORTANT:** Make sure connectors are clean prior to installation.

11. Attach the grader hydraulic hose with the male connector to the skid steer auxiliary hydraulic hose with the female connector.

12. Route the hose to avoid pinching or chafing the hose. Use nylon ties or tape to fasten hose on loader arm to keep it in place. Make sure the hose routing and length is adequate for your particular make and model skid loader.



Escaping hydraulic fluid under pressure can penetrate the skin, causing serious injury.

**DO NOT** use your hand to check for leaks. Use a piece of cardboard or paper to search for leaks.

**Stop engine and relieve pressure before connecting or disconnecting lines.**

**Tighten all connections before starting engine or pressurizing lines.**

**If any fluid is injected into the skin, obtain medical attention immediately, or gangrene may result.**

13. Mount grader control panel to skid steer with hardware provided.

14. Connect black battery wire from grader to skid steer negative battery terminal. Connect red wire to skid steer positive battery terminal.

15. Test grader for proper hydraulic flow. Change position of auxiliary hydraulic control on skid steer if grader does not respond. (See skid steer operation manual).

**NOTE:** Grader has a check valve so hydraulic oil can only flow correctly.

### To Remove Grader From Skid Steer:

1. Turn off skid steer and make sure auxiliary hydraulic controls are off (see skid steer manual).

2. Disconnect battery wires from battery terminals, starting with the negative wire. Disconnect grader control panel box wiring.

3. Disconnect auxiliary hydraulic hoses. Cap all hoses.

4. Unlatch skid steer attachment pins from grader mounting plate.

5. Lower skid steer attachment mounting plate to the ground.

6. Tilt skid steer attachment mounting plate forward and back skid steer away from grader.

## GRADER BLADE CONTROL PANEL

The grader blade control panel is intended to mount vertically inside the skid steer for easy accessibility on the operator's left side.

The Grader has four control switches:

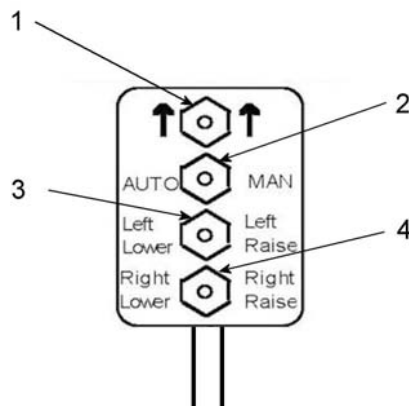

### Grader Blade Rotation Switch (1)

Press the rotation switch left to rotate the grader blade counterclockwise. Press the rotation switch right to rotate the grader blade clockwise.

### Laser Power Switch (2)

If unit is equipped with laser, press the laser power switch left to turn on. Press the laser power switch right to turn off.

### Left-Side Lift Switch (3)

Press the left-hand lift switch up to raise the left side of the grader blade. Press the left-hand lift switch down to lower the left side of the grader blade.

### Right-Side Lift Switch (4)

Press the right-hand lift switch up to raise the right side of the grader blade. Press the right-hand lift switch down to lower the right side of the grader blade.



# OPERATING INSTRUCTIONS

## PRE-OPERATION CHECKLIST

(OWNER/OPERATOR RESPONSIBILITY)

- \_\_\_ Review and follow safety rules and safety signs on pages 3 through 12.
- \_\_\_ Check that Grader Blade is properly and securely attached to skid steer.
- \_\_\_ Lubricate all grease fitting locations.
- \_\_\_ Check that all hardware is properly installed.
- \_\_\_ Check that no one enters the area of machine operation.
- \_\_\_ Know your controls and how to stop skid steer quickly in an emergency. **READ THIS MANUAL AND THE ONE PROVIDED WITH YOUR POWER UNIT.**
- \_\_\_ To avoid accident or injury, do not allow anyone to operate this equipment without proper instructions. Any person who operates this equipment must be instructed in and be capable of the safe operation of the skid steer, attachment and all controls.

## OPERATION

The operator is responsible for the safe operation of this equipment. The operator must be properly trained. Operators should be familiar with the attachment, skid steer and all safety practices before starting operation.

Make sure all operators have read the Owner's/Operator's Manual and are familiar with the instructions and the safety rules of operation.

All reference to left, right, front, or rear are given from the operator's position, facing the direction of forward travel.

**NOTE: Watch for and avoid hidden obstructions, i.e., buried pipes, rocks, concrete piers, or uneven slabs of concrete, when operating, or blade damage may occur.**

**NOTE: Stop skid steer and implement immediately upon striking an obstruction. Turn off engine, remove key, inspect, and repair any damage before resuming operation.**

## TO GRADE

1. Activate auxiliary control in skid steer (see skid steer manufacturer's operation manual).
2. Raise grader blade using the left and right-side lift switches.
3. Position loader arms on the skid steer to the frame stops.
4. Tilt attachment plate forward raising the front tires of the skid steer off the ground approximately 4"-5".
5. Adjust the grader blade downward to meet desired grade.
6. To raise blade height while grading, tilt attachment plate forward.
7. To lower blade height while grading, tilt attachment plate backward.
8. Angle blade to direct flow of material as desired.

## Tips For Operation

For best grading:

1. Start grading at perimeter of work area with blade angled to left or right.
2. Once end of first path is reached, spin around to next path, keeping blade at same angle.
3. Once end of second path is reached, double back to push excess material into next grading path. Follow this procedure, keeping blade at same angle, until grading is complete.

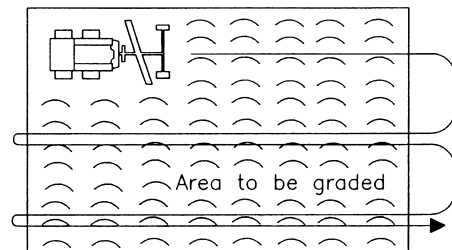

## TO LEVEL

To level an area, install the optional end plates on each end of the grader blade moldboard.

Set the blade angle at 90° to forward travel.

The optional end plates will keep excess material from leaving a ridge at the end of the moldboard and carry the material to fill in any low spots.

To order optional end plates, order #811980.

# OPERATING INSTRUCTIONS (continued)

## HYDRAULIC VALVES

---

The Model SSGB-8B grader blade is equipped with a proportional current (PC) type hydraulic valve. This valve provides smoother movement with the hydraulic cylinders.

**NOTE:** To interface with a Leica laser system, please order 2507020 Optional Laser Interface Junction Box Kit from dealer. Hydraulic valve can be integrated with other brands of laser systems; check with your laser supplier for which models are compatible. The Trimble® Model GCR-1SM Laser receiver is not compatible with the proportional current valve.

## SHEARPIN PROTECTION

---

There is an arm (part #811981) that connects the moldboard weldment of the grader to the hydraulic cylinder that angles the blade assembly.

This arm is connected to the moldboard weldment by a 5/16" X 2 1/2" standard clevis pin (part #2504244 – pkg. of 10).

These pins are available from the grader manufacturer. In an emergency, you may use a 5/16" X 2 1/2" long Grade 2 bolt. **DO NOT USE anything harder than a Grade 2 bolt!** Use of a hard bolt may result in damage to the machine.

## TRANSPORTING

---



**When traveling on public roads, whether at night or during the day, use accessory light and devices for adequate warnings to operators of other vehicles. Comply with all federal, state and local laws.**

### When Travelling To Another Work Area:

1. Tilt adjustment plate backward to place the front tires of the skid steer back on the ground.
2. Lift loader arms off the frame stops.
3. Raise grader blade.
4. Drive to new work area.

Check visibility. If visibility is impaired, reduce speed or consider other means of transport.

Allow for additional length of loader and attachment on skid steer while turning.

Select a safe ground travel speed when transporting from one area to another. When traveling on roadways, transport in such a way that faster moving vehicles may pass you safely.

When traveling over rough or hilly terrain or when making turns, slow down and use extra care.

Read all the safety warnings in the front of this manual and in the manual of skid steer.

### Transporting Unit On Truck Or Trailer:

The unit may be lifted and moved by a crane.

1. Disconnect grader from skid steer unit.
2. Secure crane hook to lift lug located on top of main frame.
3. Lift the entire unit off the ground and carefully load on truck or trailer.

If transporting unit on a trailer, tie down the unit by the torsion tube and the mounting plate.

Use extra care when loading for unloading unit onto trailer or truck.

NEVER secure rods or linkages on unit that could be damaged when securing grader to transport vehicle.

# OWNER SERVICE

## MAINTENANCE

The information in this section is written for operators who possess basic mechanical skills. If you need help, your dealer has trained service technicians available. For your protection, read and follow the safety information in this manual.

### **WARNING!**

**NEVER GO UNDERNEATH EQUIPMENT. Never place any part of the body underneath equipment or between moveable parts even when the engine has been turned off. Hydraulic system leak down, hydraulic system failures, mechanical failures, or movement of control levers can cause equipment to drop or rotate unexpectedly and cause severe injury or death.**

- **Read Manual for service instructions or have service performed by a qualified dealer.**

### **WARNING!**

**Keep all persons away from operator control area while performing adjustments, service, or maintenance.**

**Before dismantling power unit or performing any service or maintenance, follow these steps: disengage power to equipment, lower all raised components to the ground, operate valve levers to release any hydraulic pressure, set parking brake, stop engine, remove key, and unfasten seat belt. Never leave equipment unattended with engine running.**

Check hydraulic hoses and fittings for leaks. Repair any leaks immediately. Never use your hand to check for a hydraulic leak when system is under pressure.

Thoroughly clean the grease zerks before servicing. Dirt mixed with lubricant will rapidly wear parts. Keep it clean.

Periodically check all bolts to make sure they are tight.

Check hydraulic hoses. Make sure they are not chafed or pinched. Replace any damaged hose.

Replace any worn or damaged parts immediately. Do not use attachment with any damaged parts.

Replace safety signs and instruction decals if damaged or missing.

## Replacing Cutting Edge

The grader blade uses a 1/2" x 6" (12.7 x 152 mm) cutting edge. It is reversible.

1. Raise the blade.
2. Place a 4" x 4" block under the lower moldboard support. Then lower the blade so the lower moldboard support rests securely on the block.
3. Place two smaller blocks under the cutting edge so when the cutting edge is loose from the blade it doesn't fall directly on the ground (these blocks will also support the cutting edge when bolting it back on the blade).

**NOTE:** Do not block the machine any higher than necessary to remove cutting edge.

4. Refer to the Parts Drawings/Schematics on pages 21 and 22 for proper parts identification. Remove the hex nuts and plow bolts that are securing the cutting edge to the moldboard. Turn the cutting edge over and use the new edge, or replace it if both edges have been used.
5. Attach the cutting edge to the blade and secure with plow bolts and hex nuts previously removed.
6. Torque plow bolts to specifications given in Bolt Torque Chart, page 30.

## MAINTENANCE SCHEDULE

	Before Each Use	Every 100 Hours	Before Storage
Grease Unit	●		●
Clean Unit	●		●
Check Tire Pressure	●		●
Check Hydraulic Lines		●	

# SERVICE INSTRUCTIONS (continued)

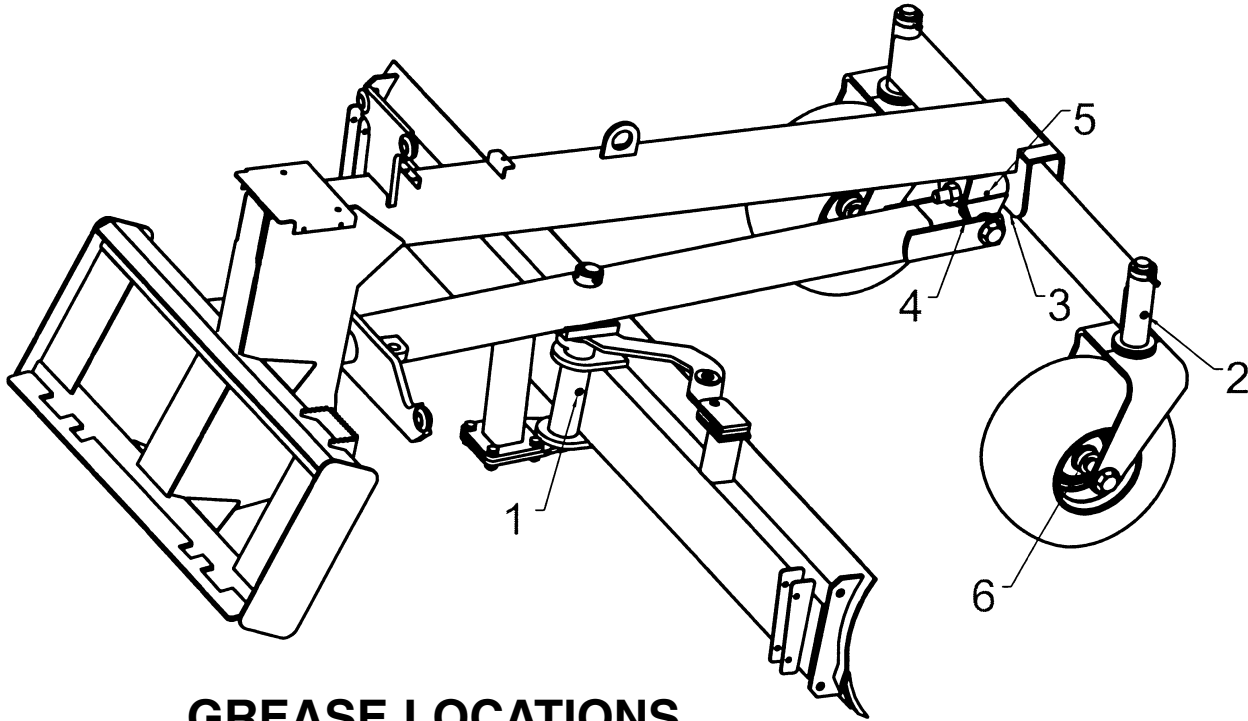

## GREASE LOCATIONS

### GRADER LUBRICATION

Thoroughly clean the grease zerks before servicing. Dirt mixed with lubricant will rapidly wear parts. Keep it clean.

Use a lithium grease of No. 2 consistency with a MOLY (molybdenum disulfide) additive for all locations.

Lubricate the following points:

1. Blade Pivot Spindle
2. Caster Pivot Spindles
3. Front Axle Pivot
4. Torsion Beam Pivot (Vertical)
5. Torsion Beam Pivot (Tilt)
6. Caster Wheel Hubs

### CHECK TIRE PRESSURE

Adjust the tire pressure for all tires to 50 psi (346 KN/m<sup>2</sup>). Keep tire valves capped.

### CHECK HYDRAULIC LINES

Check the hydraulic lines every 100 operating hours.

Inspect hoses for wear, cracks, loose connections, leaks, etc. Repair hoses as needed.

**IMPORTANT:** Moving hydraulic hoses should be replaced every two years or as wear dictates.

### STORAGE

- At the end of the working season or when the Grader Blade will not be used for a long period, it is good practice to clean off any dirt or grease that may have accumulated.
- Inspect the Grader Blade for loose, damaged or worn parts and adjust or replace if needed.
- Always store in a clean, dry location away from children and livestock.
- Storage location should be level and solid to make hitching and unhitching easy.
- Grease the unit.
- Check and adjust the tire pressure.
- Place plastic caps on the hydraulic hose ends.
- Check all bolts, nuts, screws and tighten.
- Touch up all areas where paint has been removed.
- Cover the unit to keep it clean.
- Coat hydraulic cylinder rods with lithium based grease.

# TROUBLE-SHOOTING GUIDE

---

<b>PROBLEM</b>	<b>POSSIBLE CAUSE</b>	<b>POSSIBLE REMEDY</b>
<b>Grader does not sit properly on skid steer attachment plate.</b>	<ol style="list-style-type: none"> <li>1. Obstruction between grader and attachment plate.</li> </ol>	<ol style="list-style-type: none"> <li>1. Check to see that the attachment plate is free of foreign obstacles. Make sure attachment plate pins are fully retracted.</li> </ol>
<b>Grader blade inoperative.</b>	<ol style="list-style-type: none"> <li>1. Auxiliary hydraulic hoses not connected.</li> <li>2. Auxiliary hydraulics not engaged.</li> <li>3. Skid steer auxiliary hydraulic control lever or pedal is operated in wrong direction (check valve only allows correct flow direction).</li> <li>4. No electric power to valve.</li> <li>5. Blown fuse.</li> </ol>	<ol style="list-style-type: none"> <li>1. Connect hoses. See <i>Grader Installation/Removal</i>.</li> <li>2. Turn on auxiliary hydraulics.</li> <li>3. Change direction of auxiliary hydraulic control (refer to skid steer operation manual).</li> <li>4. Check electrical connections.</li> <li>5. Check fuse in wire harness. Replace if necessary.</li> </ol>
<b>Shearpin arm and/or plate weldment bent.</b>	<ol style="list-style-type: none"> <li>1. Hard bolt or shearpin installed.</li> </ol>	<ol style="list-style-type: none"> <li>1. Use only factory 5/16" X 2 1/2" standard shearpins or Grade 2 bolt.</li> </ol>
<b>Electric controls don't match grader blade movement.</b>	<ol style="list-style-type: none"> <li>1. Electrical connections incorrect.</li> <li>2. Broken wire.</li> </ol>	<ol style="list-style-type: none"> <li>1. Refer to wiring diagram and laser manual.</li> <li>2. Check wiring harness and switch connections.</li> </ol>
<b>Laser system problem.</b>	<ol style="list-style-type: none"> <li>1. See laser owner's manual.</li> </ol>	

# TROUBLE-SHOOTING GUIDE (continued)

PROBLEM	POSSIBLE CAUSE	POSSIBLE REMEDY
<b>Hydraulic oil overheats.</b>	<ol style="list-style-type: none"> <li>1. Oil level low.</li> <li>2. Dirty filters.</li> <li>3. Reservoir of power unit too small.</li> </ol>	<ol style="list-style-type: none"> <li>1. Check oil level in power unit reservoir.</li> <li>2. Change oil and filters in power unit per manufacturer's recommendations.</li> <li>3. Allow time for oil to cool down.</li> </ol>
<b>Hydraulic hose failure.</b>	<ol style="list-style-type: none"> <li>1. Hose being pinched.</li> <li>2. Hoses worn or frayed.</li> <li>3. Hydraulic relief pressure on power unit too high.</li> </ol>	<ol style="list-style-type: none"> <li>1. Reroute hose and fasten out of harms way.</li> <li>2. Replace hose.</li> <li>3. Adjust relief pressure (if possible) or change power unit.</li> </ol>
<b>Blade will not penetrate soil.</b>	<ol style="list-style-type: none"> <li>1. Cutting edge dull.</li> <li>2. Soil too hard.</li> </ol>	<ol style="list-style-type: none"> <li>1. Replace cutting edge.</li> <li>2. Loosen soil with scarifiers or disk. Wait for rain.</li> </ol>
<b>Grader blade moldboard shear pin shears excessively.</b>	<ol style="list-style-type: none"> <li>1. Hitting hidden objects.</li> <li>2. Hitting end of moldboard on stumps, concrete curb, or corner of building.</li> <li>3. Do not load either end of the blade heavily. Try to balance the load on both ends of the blade.</li> </ol>	<ol style="list-style-type: none"> <li>1. Know soil conditions. Use slow speed when soil conditions unknown. Always check work area.</li> <li>2. Have operator use care when driving close to obstacles.</li> <li>3. Retrain operator.</li> </ol>
<b>Unable to hold level grade.</b>	<ol style="list-style-type: none"> <li>1. Soil too hard.</li> <li>2. Skid steer loader arms leaking up.</li> <li>3. Possible laser control problem.</li> </ol>	<ol style="list-style-type: none"> <li>1. Loosen soil with scarifiers or disk.</li> <li>2. Check seals in loader arm lift cylinders and valve.</li> <li>3. See if problem persists with laser control off and check laser manual.</li> </ol>

# SSGB-8B GRADER BLADE HYDRAULIC DIAGRAM & PARTS LIST

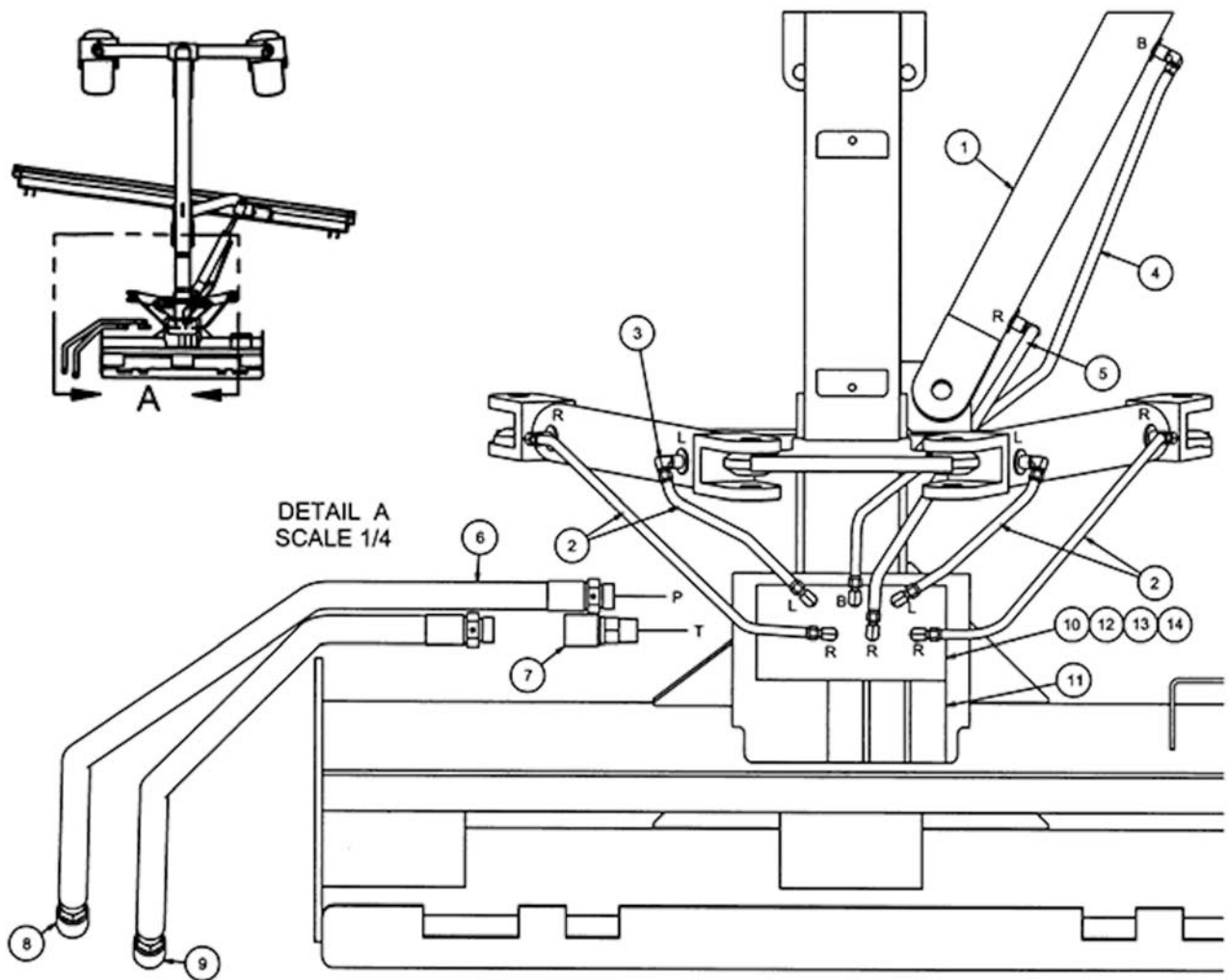

## Parts List

Item	Qty.	Part Number	Description
1	3	2505663	Hydraulic Cylinder 2 x 12
	1	2504239	Seal Kit (for 2 x 12 Hydraulic Cylinder)
2	4	2505692	Hose, Hydraulic 1/4" x 23"
3	12	2505696	Adapter, Hyd. 90 Deg. Adj. Elbow 7/16"
4	1	2505694	Hose, Hydraulic 1/4" x 51"
5	1	2505693	Hose, Hydraulic 1/4" x 47"
6	2	2505695	Hose, Hydraulic 3/4" x 65"
7	1	2505691	Check Valve, SAE 12 (1-1/16"-12UN)
8	1	2505661	Coupler, Flat Face, 1/2"NPT Female
9	1	2505662	Coupler, Flat Face, 1/2"NPT Male
10	1	2505714	Hydraulic Valve
11	6	2505730	Replacement Coil, 12V DC
12	3	2503011	Bolt, 1/4"-20NC x 1" Hex Head Gr.2
13	3	2502008	Washer, 3/8" Spring Lock
14	3	2505731	Replacement Spool Cartridge

# SSGB-8B GRADER BLADE PARTS DRAWING

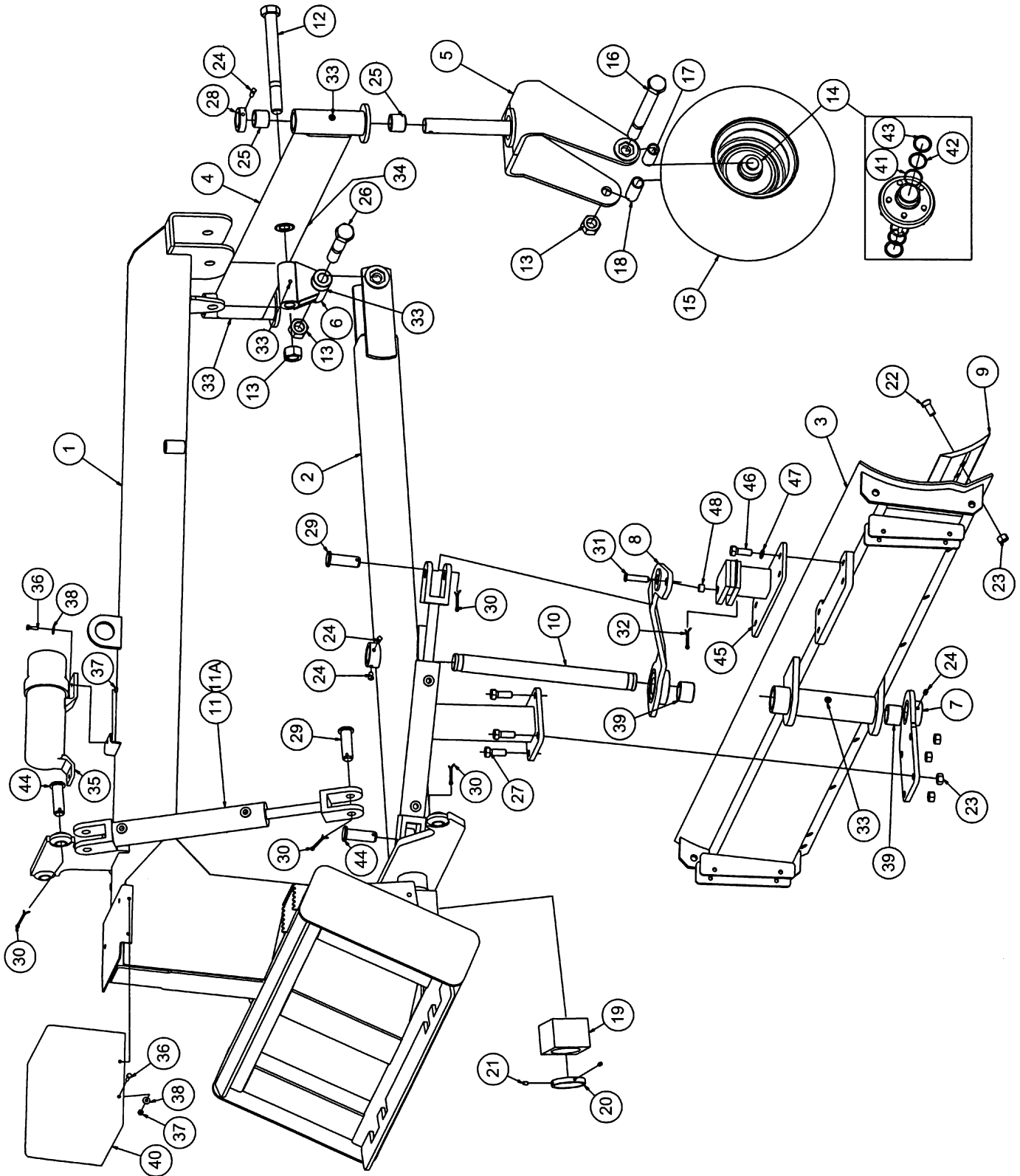



# GRADER BLADE PARTS LIST

Ref. No.	Part No.	Description	No. Req'd.
1	811905	Main Frame Weldment	1
2	811920	Torsion Tube Weldment	1
3	811931	Moldboard Weldment 8 Ft.	1
4	811941	Front Axle Weldment	1
5	811955	Caster Fork Weldment	2
6	811960	Torsion Tube Pivot Weldment	1
7	811951	Shaft Support Plate Weldment	1
8	811981	Arm Weldment, Moldboard Position	1
9	350105	Cutting Edge 8 Ft.	1
10	811990	Shaft, Blade Pivot	1
11	2505663	Hydraulic Cylinder 2 x 12	3
11A	2504239	Seal Kit (for 2 x 12 Hydraulic Cylinder)	1
12	2503322	Bolt 1"-8NC x 11" Hex Head Gr.5	1
13	2500045	Nut 1"-8NC Hex Nylock	4
14	811976	Hub Assembly, 5 Bolt w/ Bearings and Seal	2
15	811977	Wheel and Tire Assembly	2
16	2503321	Bolt 1"-8NC x 12" Hex Head Gr.5	2
17	811979	Spacer, Wheel (3.25 Lg.)	2
18	811978	Spacer, Wheel (2.75 Lg.)	2
19	811935	Slide Block (UHMW)	1
20	811993	Ring w/Set Screw Holes	1
21	2503057	Set Screw 5/16"-18NC x 1/2"	2
22	2503045	Bolt 5/8"-11NC x 1-1/2" Plow Head Gr.5	10
23	2500094	Nut, 5/8"-11NC Hex Toplock Gr.5	14
24	2503056	Set Screw, Sq. Head 3/8" x 1/2"	5
25	2505033	Spring Bushing, 1.75 x 1.50 x 1.50	4
26	811946	Bolt, Modified Hex 1"-8NC x 6-5/8" Gr.5 (Special)	1
27	2503175	Bolt, 5/8"-11NC x 1-3/4" Hex Head Gr.5	4
28	2504237	Set Collar, 1.50 ID	2
29	863070	Hydraulic Cylinder Pin 1" Dia. X 3-1/4"	3
30	2504121	Cotter Pin 3/16" x 1-1/2"	6
31	2504244	Shear Pin 5/16" x 2-1/2" w/Clips (Pkg. of 10) (Clevis Pin)	1
32	590185	Clip, Hair Pin - Replacement only	1
33	2504049	Drive Zerk, 5/16"	5
34	2504188	Grease Zerk, 1/8"NPT x 2-3/4"	1
35	2504225	Manual Holder, Plastic	1
36	2503116	Bolt, 1/4"-20NC x 1" Hex Head Gr.2	6
37	2500008	Nut, 1/4"-20NC Whiz Flange Hex	6
38	2501006	Washer, 1/4" Medium Flat	6
39	2505037	Spring Bushing, 2.00 x 1.75 x 1.50	2
40	811950	Cover, Hydraulic Valve	1
41	2505038	Cup, Timken # L44610	4
42	2505039	Cone, Timken # L44643	4
43	2505040	Seal, Reliable # SL-122-1	4
44	863068	Hydraulic Cylinder Pin 1" Dia. X 2-1/2"	3
45	811985	Shear Plate Weldment	1
46	2503154	Bolt, 5/8"-11NC x 1-1/2" Hex Head Gr.5	4
47	2502007	Washer, 5/8" Springlock	4
48	811997	Bushing, Shear Pin	3

# SSGB-8B GRADER BLADE WIRING DIAGRAM & PARTS LIST

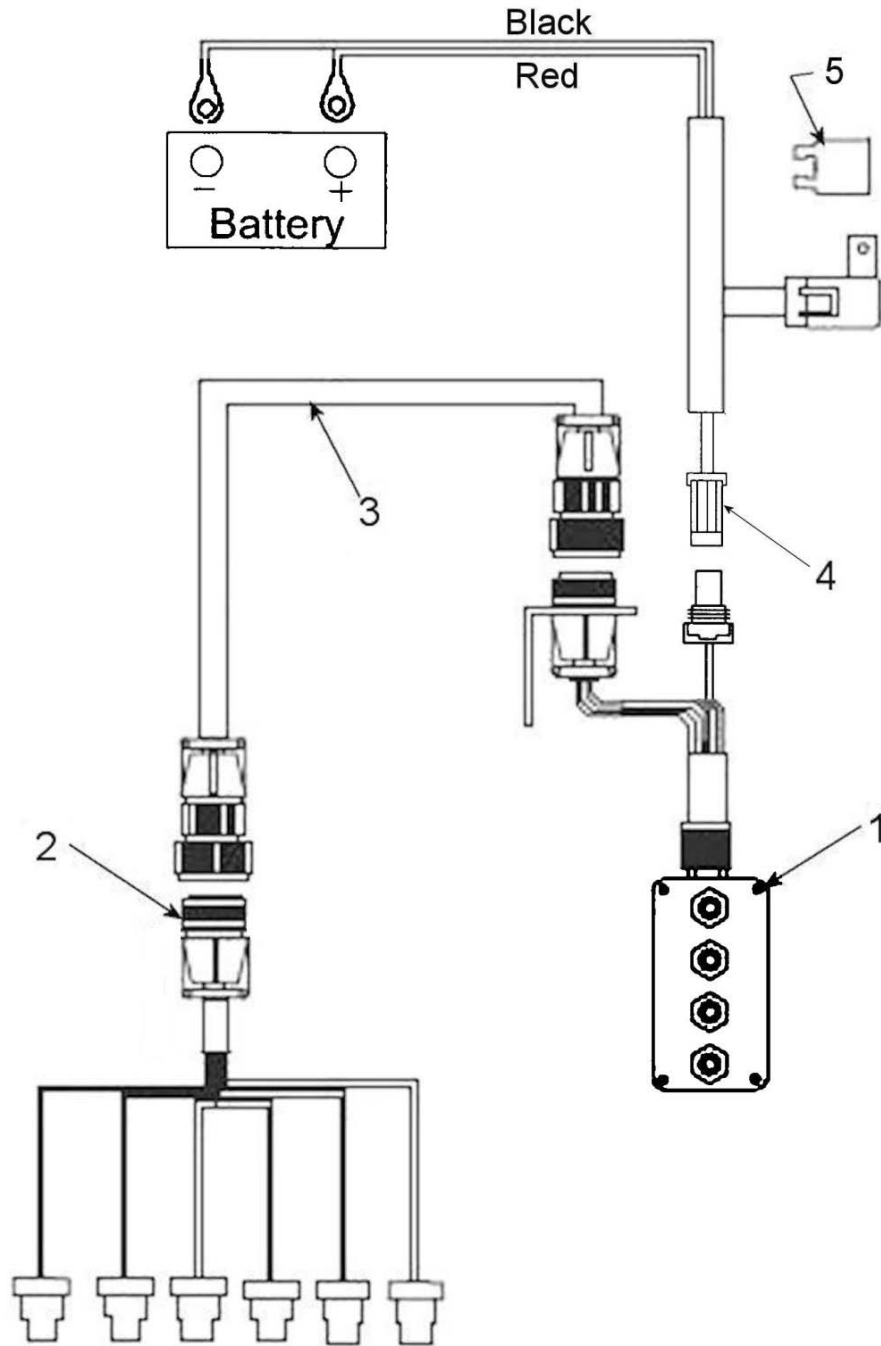

Item No.	Part No.	Description
1	2507019	Remote Control Switch Box
2	2507021	Hydraulic Valve Cable Harness
3	2507022	Interface Cable Harness Extension
4	Incl. in Item 1	Battery Cable Harness
5	Incl. in Item 1	10 Amp Fuse

# SSGB-8B GRADER BLADE WIRING CONNECTION INSTRUCTIONS

Hydraulic  
Solenoid  
Valve

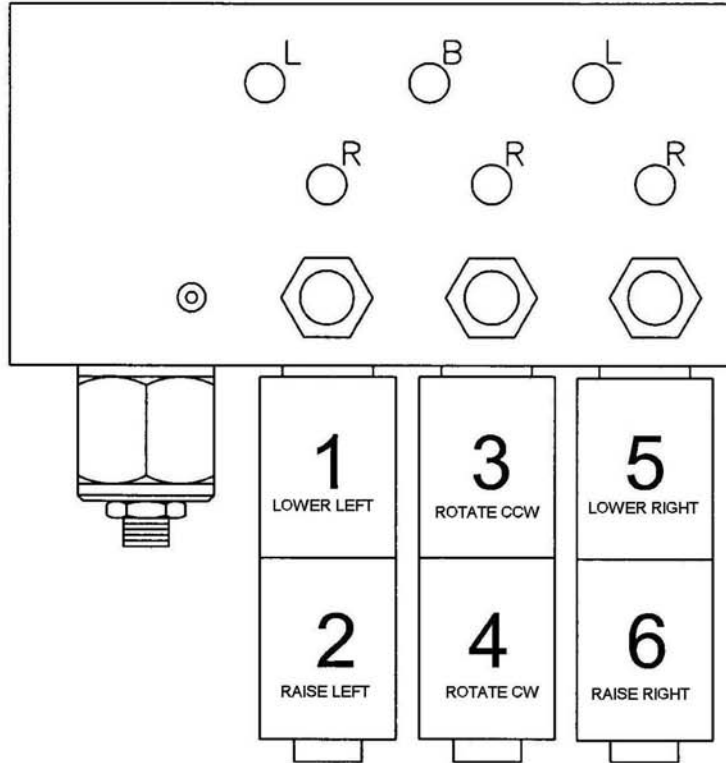

Electric Valve  
Harness

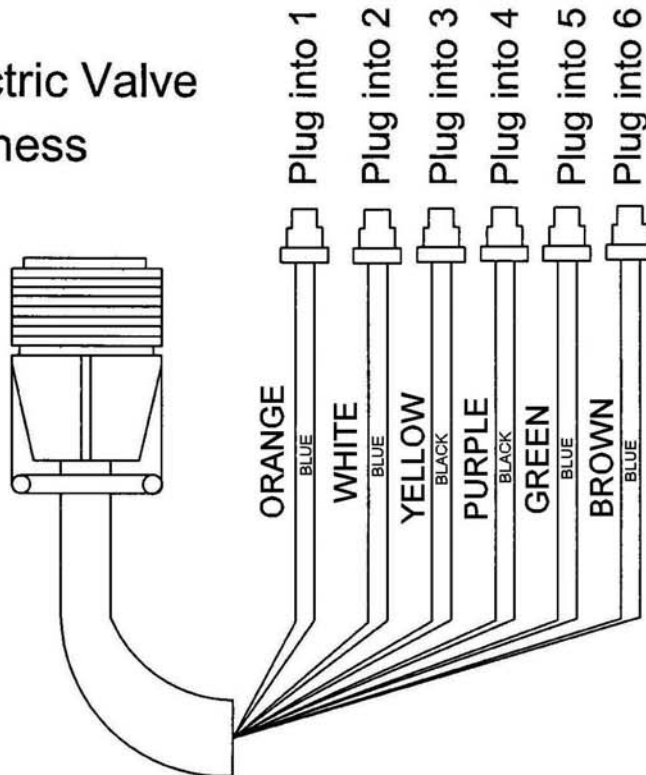

# SSGB-8B GRADER BLADE ELECTRICAL SCHEMATIC

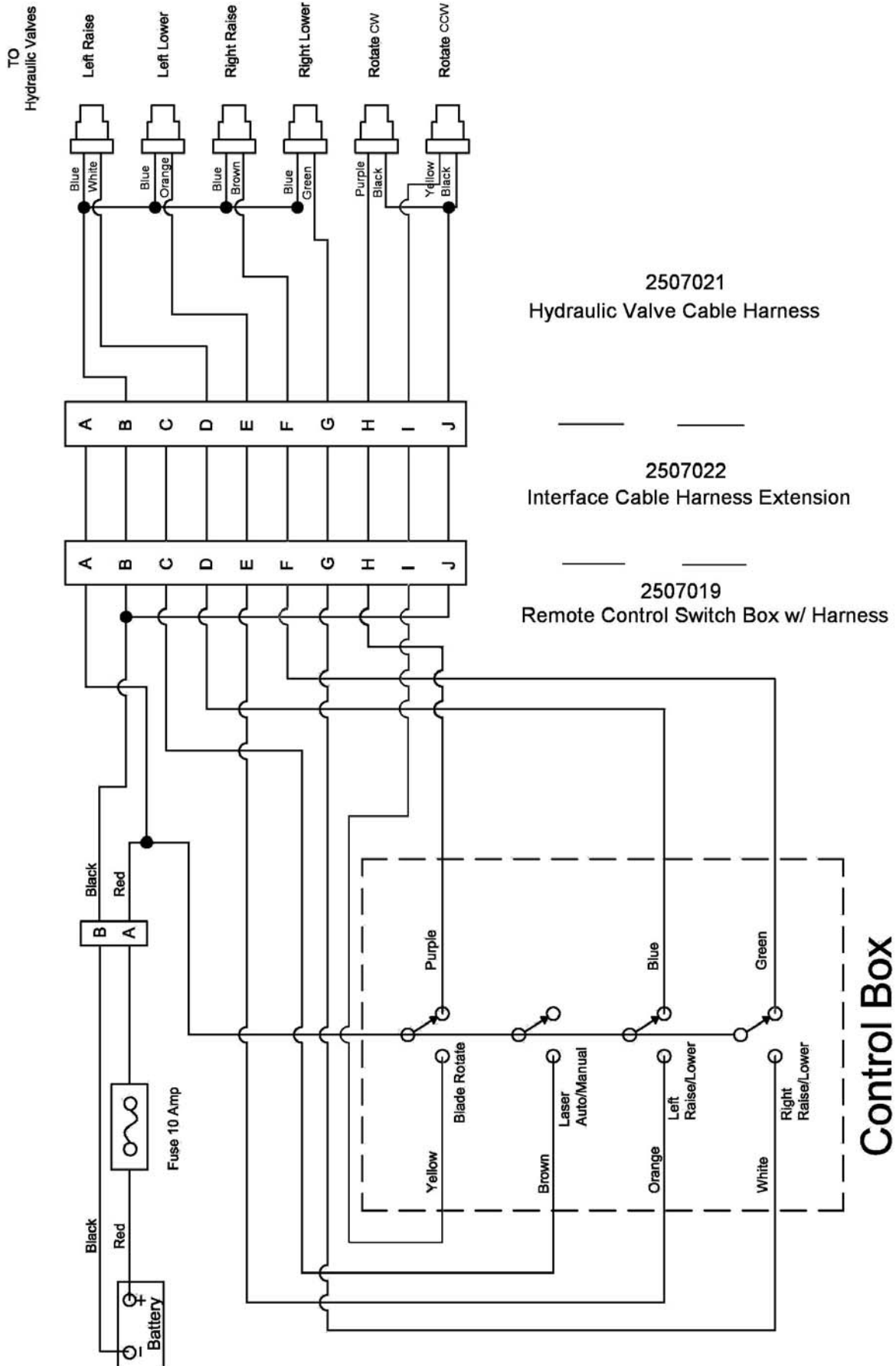

# SSGB-8B GRADER BLADE OPTIONAL END PLATE KIT PARTS DRAWING & LIST

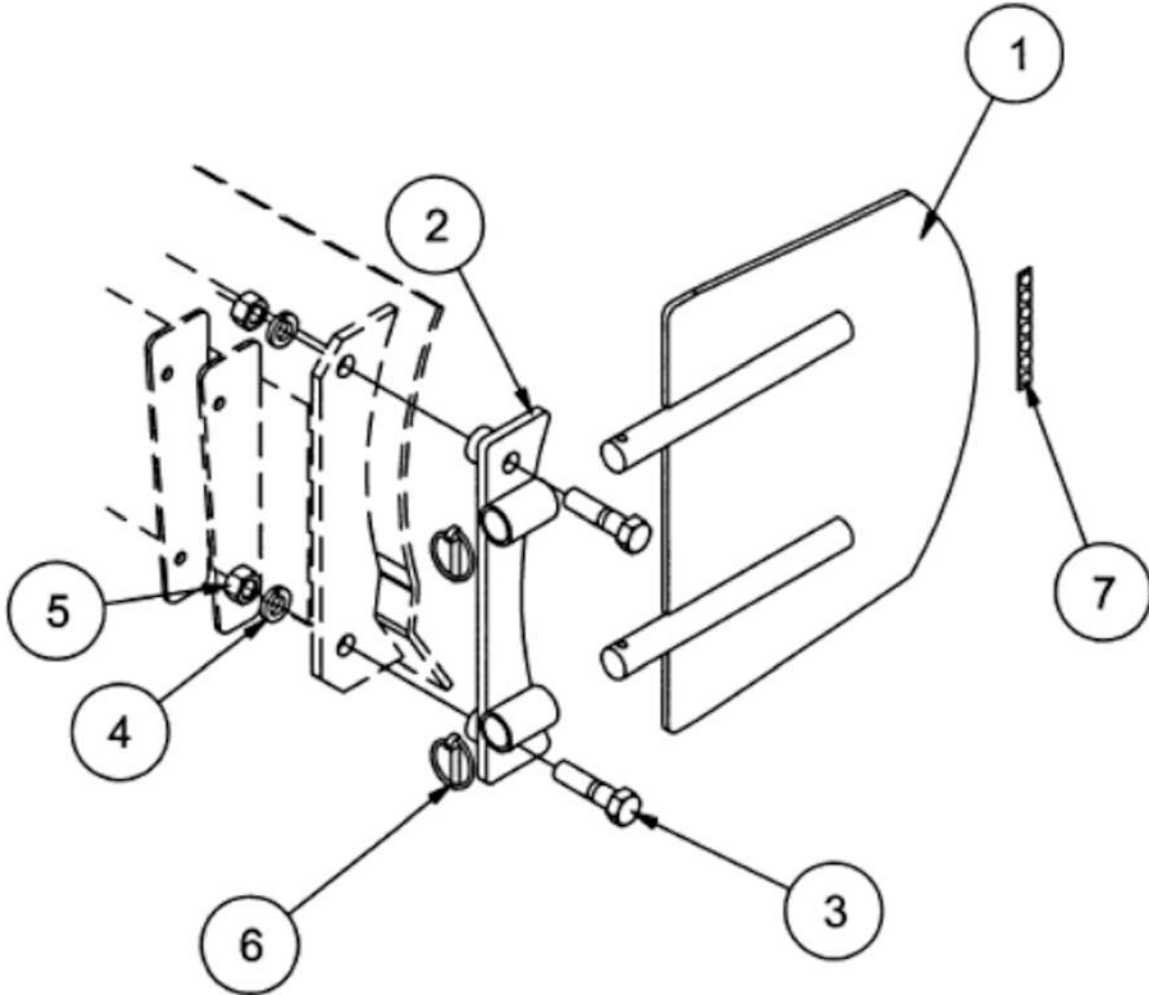

Optional End Plate Kit Part No. 811980			
Item	Qty.	Part Number	Description
1	2	811971	Endplate Weldment
2	2	811968	Endplate Bracket
3	4	2503088	Bolt, 5/8"-11NC x 2-1/2" Hex Head Gr.5
4	4	2502007	Washer 5/8" Spring Lock
5	4	2500013	Nut 5/8"-11NC Ful Hex
6	4	590034	Ak-61 Linchpin 1/4"
7	1	812009	Strip of Rubber Bumpers

# SSGB-8B GRADER BLADE OPTIONAL LASER POLE KIT PARTS DRAWING & LIST

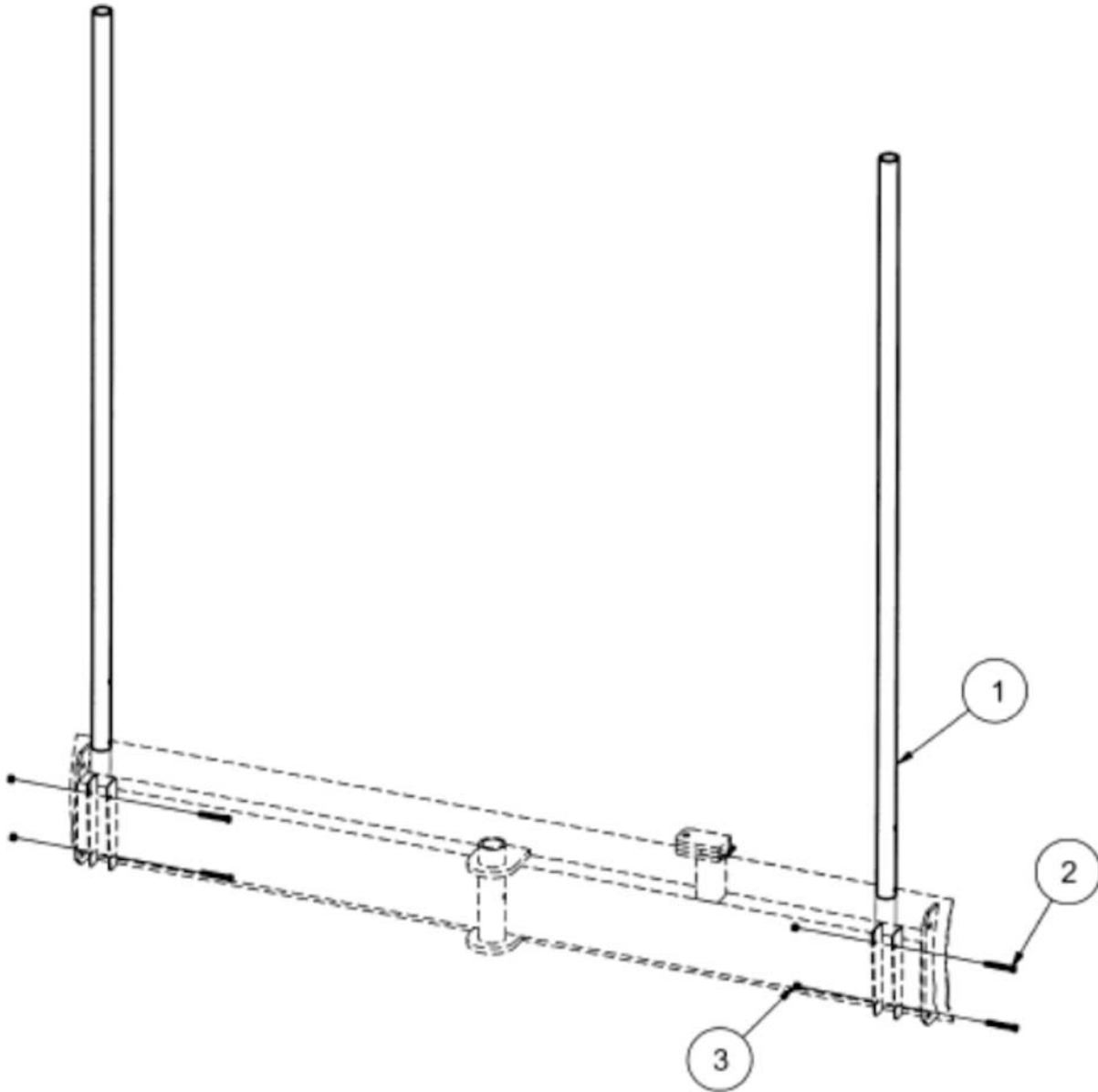

Laser Pole Kit Part No. 812110			
Item	Qty.	Part Number	Description
1	2	811995	Laser Pole
2	4	2503072	Bolt, Hex 3/8"-16NC x 3" Gr.5
3	4	2500081	Nut, Hex 3/8"-16NC Whiz Flange

# SKID STEER GRADER BLADE SPECIFICATIONS

Item .....	#811940
Model .....	SSGB-8B
<hr/>	
Overall Height .....	46.5"
Overall Length .....	98"
Overall Width .....	95.5"
<hr/>	
Shipping Weight .....	1385 Lbs.
Operating Weight .....	1195 Lbs.
<hr/>	
Skid Steer Connection .....	Universal Skid Steer
<hr/>	
Moldboard Width .....	95.5"
Moldboard Height .....	15" with Cutting Edge
Moldboard Width, Fully Angled .....	85"
Moldboard Rotation Left & Right .....	25 Degrees
Moldboard Tilt Up or Down .....	25 Degrees
<hr/>	
Reversible Moldboard Cutting Edge .....	1/2" X 6" Double Bevel
Moldboard Shear Pin Protection .....	5/16" Diameter Shear Pin (soft)
<hr/>	
3 Hydraulic Cylinders .....	2" Bore X 12" Stroke (3500 psi)
Flat-Faced Couplers Included .....	1/2" Body – Connect Under Pressure
<hr/>	
Grader Control Valve .....	Electric Solenoid Operated
In-Cab Remote Control .....	Standard
<hr/>	
Recommended Min. Skid Steer H.P. ....	45 H.P.
Wheel Bearings .....	Greasable Tapered Roller
Tire Size .....	18.5 X 8.5 - 8

---



---

## OPTIONS

End Plate Kit (Pair) .....	#811980
Laser Pole Kit (Pair) .....	#812110
Leica Laser Interface Junction Box Kit .....	#2507020
Laser Control Kit .....	Contact Dealer

# BOLT TORQUE CHART

Always tighten hardware to these values unless a different torque value or tightening procedure is listed for a specific application.

Fasteners must always be replaced with the same grade as specified in the manual parts list.

Always use the proper tool for tightening hardware: SAE for SAE hardware and Metric for metric hardware.

Make sure fastener threads are clean and you start thread engagement properly.

All torque values are given to specifications used on hardware defined by SAE J1701 & J1701M JUL96.

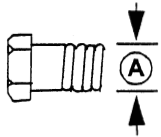

## SAE SERIES TORQUE CHART



SAE Bolt Head Identification



A Diameter (Inches)	Wrench Size	MARKING ON HEAD					
		SAE 2		SAE 5		SAE 8	
		lbs-ft	N-m	lbs-ft	N-m	lbs-ft	N-m
1/4"	7/16"	6	8	10	13	14	18
5/16"	1/2"	12	17	19	26	27	37
3/8"	9/16"	23	31	35	47	49	67
7/16"	5/8"	36	48	55	75	78	106
1/2"	3/4"	55	75	85	115	120	163
9/16"	13/16"	78	106	121	164	171	232
5/8"	15/16"	110	149	170	230	240	325
3/4"	1-1/8"	192	261	297	403	420	569
7/8"	1-5/16"	306	416	474	642	669	907
1"	1-1/2"	467	634	722	979	1020	1383

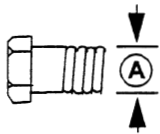

## METRIC SERIES TORQUE CHART



Metric Bolt Head Identification



A Diameter & Thread Pitch (Millimeters)	Wrench Size	COARSE THREAD				FINE THREAD				A Diameter & Thread Pitch (Millimeters)
		MARKING ON HEAD				MARKING ON HEAD				
		Metric 8.8		Metric 10.9		Metric 8.8		Metric 10.9		
		N-m	lbs-ft	N-m	lbs-ft	N-m	lbs-ft	N-m	lbs-ft	
6 x 1.0	10 mm	8	6	11	8	8	6	11	8	6 x 1.0
8 x 1.25	13 mm	20	15	27	20	21	16	29	22	8 x 1.0
10 x 1.5	16 mm	39	29	54	40	41	30	57	42	10 x 1.25
12 x 1.75	18 mm	68	50	94	70	75	55	103	76	12 x 1.25
14 x 2.0	21 mm	109	80	151	111	118	87	163	120	14 x 1.5
16 x 2.0	24 mm	169	125	234	173	181	133	250	184	16 x 1.5
18 x 2.5	27 mm	234	172	323	239	263	194	363	268	18 x 1.5
20 x 2.5	30 mm	330	244	457	337	367	270	507	374	20 x 1.5
22 x 2.5	34 mm	451	332	623	460	495	365	684	505	22 x 1.5
24 x 3.0	36 mm	571	421	790	583	623	459	861	635	24 x 2.0
30 x 3.0	46 mm	1175	867	1626	1199	1258	928	1740	1283	30 x 2.0

### Typical Washer Installations

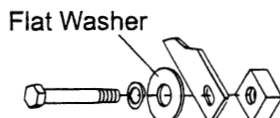
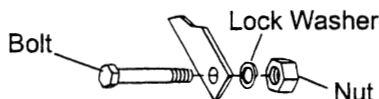

8/9/00









# **⚠ SAFETY PRECAUTIONS ⚠**

**MOST ACCIDENTS OCCUR BECAUSE OF NEGLIGENCE OR CARELESSNESS.  
AVOID NEEDLESS ACCIDENTS BY FOLLOWING ALL OF THE SAFETY PRECAUTIONS LISTED BELOW.**

- Machinery should be operated only by those who are responsible and are authorized to do so.
- Stop the engine, lower all equipment, lock the brakes, and remove the ignition key before dismounting from the skid steer.
- Never stand between skid steer and attachment while skid steer is being connected to the attachment.
- Loose fitting clothing should not be worn, to avoid catching on various parts.
- Detach attachment in area where children normally do not play.
- When performing adjustments or maintenance on an attachment, first lower it to the ground or block it securely at a workable height.
- Only a qualified operator should be permitted on skid steer when in operation; no riders allowed.
- Make certain everyone is in the clear before starting tractor or raising or lowering equipment.
- Operate the skid steer and attachment only while seated in the driver's seat.
- Reduce speed when transporting mounted attachments to avoid bouncing and momentary loss of steering control.
- A heavy load can cause instability of the skid steer. Use extreme care during road travel. Slow down on turns and watch out for bumps. Skid steer may need front counterweights to counter-balance the weight of the attachment.
- Reduce speed on hillsides or curves so there is no danger of tipping.
- Avoid driving too close to the edge of ditches or drop offs.
- Do not transport implement on public roads without reflectors and slow moving vehicle emblem in daylight and with approved warning lights at night and other periods of poor visibility.
- Keep work area clear of all debris. Never assume an area is clear. **ALWAYS CHECK.**
- Check to make certain there are no buried utilities in the work area before starting work.
- Keep alert and watch the front as well as the rear when working with the attachment.

**OWNER'S/  
OPERATOR'S  
MANUAL**

**MODEL NO.  
SSGB-8B**

OCTOBER 2015

## **SKID STEER MOUNTED GRADER BLADE**

**WHEN ORDERING REPAIR PARTS,  
ALWAYS GIVE THE FOLLOWING INFORMATION:**

1. PART NUMBER
2. PART DESCRIPTION
3. MODEL NUMBER
4. NAME OF ITEM

**MAKE EVERY DAY  
A HOLIDAY  
FROM ACCIDENTS!**

**WORKSAVER, INC.**

P.O. BOX 100 LITCHFIELD, IL 62056-0100 (217) 324-5973  
WEB: <http://www.worksaver.com> E-MAIL: [sales@worksaver.com](mailto:sales@worksaver.com)