

# OWNER'S/ OPERATOR'S MANUAL

**MODEL NO.  
SS-590**

## **CAUTION**

For Safe Operation  
Read Rules And  
Instructions Carefully

SI NO LEEINGLES, PIDA AYUDA  
A AIGUIEN QUE SI LO LEA  
PARA QUE LE TRADUZCA LAS  
MEDIDAS DE SEGURIDAD.

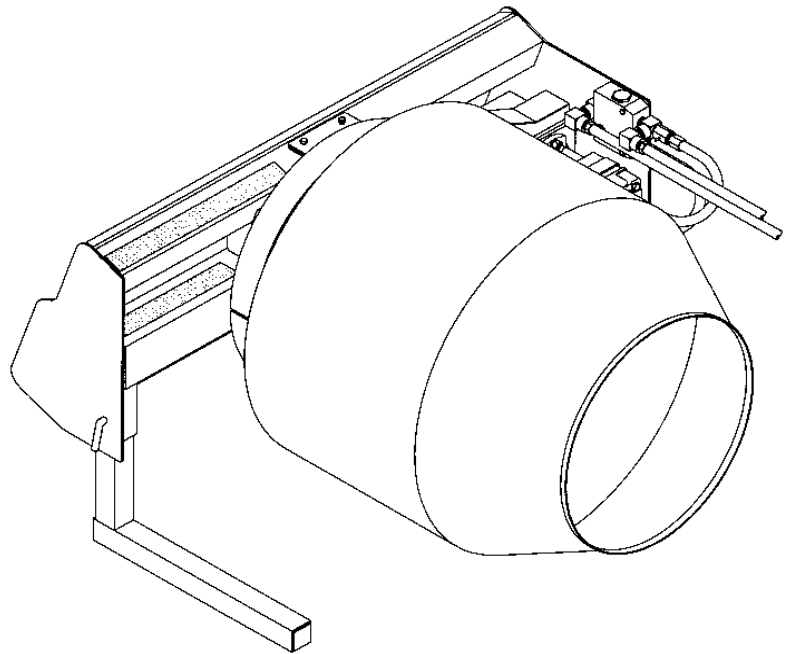

# SKID STEER MOUNTED HYDRAULIC MIXER

**Safety Instructions  
Tractor Preparation  
Operating Instructions**

**Assembly & Mounting  
Maintenance  
Repair Parts**

## **CAUTION**

**THE FOLLOWING SAFETY PRECAUTIONS SHOULD BE THOROUGHLY UNDERSTOOD  
BEFORE ATTEMPTING TO BEGIN ASSEMBLING THIS MACHINE**

1. Select an area for assembly that is clean and free of any debris which might cause persons working on the assembly to trip.
2. Do not lift heavy parts or assemblies. Use crane, jack, tackle, fork trucks or other mechanical devices.
3. Preview the assembly instructions in your operator's manual before proceeding further.
4. If the assembly instructions call for parts or assemblies to be blocked up, use only blocking material that is in good condition and is capable of handling the weight of the assembly to be blocked. Also insure that the blocking material is on a clean, dry surface.
5. Never put hands, or any part of body, under blocked up assemblies if at all possible.
6. After completing assembly, thoroughly inspect the machine to be sure that all nuts, bolts, hydraulic fittings or any other fastened assemblies have been thoroughly tightened.
7. Before operating the machine, thoroughly read the operation section of your operator's manual.
8. Before operating, read the maintenance section of your operator's manual to be sure that any parts requiring lubrication, such as gearboxes, are full, to avoid any possible damage.
9. **Before operating equipment – If you have any questions regarding the proper assembly or operation, contact your dealer or representative.**

# TABLE OF CONTENTS

WARRANTY .....	2
SAFETY INFORMATION .....	3
SAFETY SIGNS .....	11
PREPARATION INSTRUCTIONS .....	12
SKID STEER INSTRUCTIONS .....	13
OPERATING INSTRUCTIONS .....	14
MIX INSTRUCTIONS .....	15
TROUBLE-SHOOTING .....	16
PARTS LISTS .....	17 - 19
SPECIFICATIONS .....	20

SI NO LEEINGLES, PIDA AYUDA A AIGUIEN QUE SI LO LEA PARA QUE LE TRADUZCA LAS MEDIDAS DE SEGURIDAD.

## STATEMENT OF POLICY

It is the policy of Worksaver, Inc. to improve its products where it is possible and practical to do so. Worksaver, Inc. reserves the right to make changes or improvements in design and construction at any time, without incurring the obligation to make these changes on previously manufactured units.

## TO THE OWNER:

Read this manual before using your Hydraulic Mixer. This manual is provided to give you the necessary operating and maintenance instructions for keeping your Hydraulic Mixer in top operating condition. Please read this manual thoroughly. Understand what each control is for and how to use it. Observe all safety signs on the machine and noted throughout the manual for safe operation of implement. Keep this manual handy for ready reference.

Like all mechanical products, it will require cleaning and upkeep. Lubricate the Mixer as specified.

Use only genuine Worksaver, Inc. service parts. Substitute parts will void the warranty and may not meet standards required for safe and satisfactory operation. Record the model and serial number of your Mixer here:

Model: \_\_\_\_\_ Serial Number: \_\_\_\_\_

---

---

## RETAIL CUSTOMER'S RESPONSIBILITY

**It is the Retail Customer and/or Operator's responsibility to read the Operator's Manual, to operate, lubricate, maintain, and store the product in accordance with all instructions and safety procedures. Failure of the operator to read the Operator's Manual is a misuse of this equipment.**

**It is the Retail Customer and/or Operator's responsibility to inspect the product and to have any part(s) repaired or replaced when continued operation would cause damage or excessive wear to other parts or cause a safety hazard.**

**It is the Retail Customer's responsibility to deliver the product to the authorized Worksaver Dealer, from whom he purchased it, for service or replacement of defective parts which are covered by warranty. Repairs to be submitted for warranty consideration must be made within forty-five (45) days of failure.**

**It is the Retail Customer's responsibility for any cost incurred by the Dealer for traveling to or hauling of the product for the purpose of performing a warranty obligation or inspection.**

# LIMITED WARRANTY



Worksaver warrants to the original purchaser of any new Hydraulic Mixer Model 590, that the equipment be free from defects in material and workmanship for a period of six (6) months for non-commercial, state, and municipalities. Use sixty (60) days for commercial use from date of retail sale.

Replacement or repair parts installed in the equipment covered by this warranty are warranted for ninety (90) days from the date of purchase of such part or to the expiration of the applicable new equipment warranty period, whichever occurs later.

Such parts shall be provided at no cost to the user during regular working hours. Worksaver reserves the right to inspect any equipment or parts which are claimed to have been defective in material or workmanship.

## DISCLAIMER OF IMPLIED WARRANTIES & CONSEQUENTIAL DAMAGES

Worksaver's obligation under this warranty, to the extent allowed by law, is in lieu of all warranties, implied or expressed, including implied warranties of merchantability and fitness for a particular purpose and any liability for incidental and consequential damages with respect to the sale or use of the items warranted. Such incidental and consequential damages shall include but not be limited to: transportation charges other than normal freight charges; cost of installation other than cost approved by Worksaver; duty; taxes; charges for normal service or adjustments; loss of crops or any other loss of income; rental of substitute equipment, expenses due to loss, damage, detention or delay in the delivery of equipment or parts resulting from acts beyond the control of Worksaver.

## THIS WARRANTY SHALL NOT APPLY:

1. To vendor items which carry their own warranties, such as hydraulic motors, tires, and tubes.
2. If the unit has been subjected to misapplication, abuse, misuse, negligence, fire or other accident.
3. If parts not made or supplied by Worksaver have been used in connection with the unit, if, in sole judgement of Worksaver such use affects its performance, stability, or reliability.
4. If the unit has been altered or repaired outside of an authorized Worksaver dealership in a manner which, in the sole judgement of Worksaver affects its performance, stability or reliability.
5. To normal maintenance service and normal replacement items such as gearbox lubricant, hydraulic fluid, worn blades, or to normal deterioration of such things as belts and exterior finish, due to use or exposure.
6. To expendable or wear items such as mixer drum, paddles, springs and other items that in the company's sole judgement is a wear item.

NO EMPLOYEE OR REPRESENTATIVE OF WORKSAVER IS AUTHORIZED TO CHANGE THIS WARRANTY IN ANY WAY OR GRANT ANY OTHER WARRANTY UNLESS SUCH CHANGE IS MADE IN WRITING AND SIGNED BY WORKSAVER'S SERVICE MANAGER, POST OFFICE BOX 100, LITCHFIELD, ILLINOIS 62056-0100.



# To the Owner/Operator/Dealer

All implements with moving parts are potentially hazardous. There is no substitute for a cautious, safe-minded operator who recognizes the potential hazards and follows reasonable safety practices. The manufacturer has designed this implement to be used with all its safety equipment properly attached to minimize the chance of accidents.

## BEFORE YOU START!!

Read the safety messages on the implement and shown in your manual.  
Observe the rules of safety and common sense!



THIS SYMBOL MEANS

- ATTENTION!
- BECOME ALERT!
- YOUR SAFETY IS INVOLVED!

THIS SAFETY ALERT SYMBOL IDENTIFIES IMPORTANT SAFETY WARNING MESSAGES. CAREFULLY READ EACH WARNING MESSAGE THAT FOLLOWS. FAILURE TO UNDERSTAND AND OBEY A SAFETY WARNING, OR RECOGNIZE A SAFETY HAZARD, COULD RESULT IN AN INJURY OR DEATH TO YOU OR OTHERS AROUND YOU. THE OPERATOR IS ULTIMATELY RESPONSIBLE FOR THE SAFETY OF HIMSELF, AS WELL AS OTHERS, IN THE OPERATING AREA OF THE TRACTOR AND ATTACHED EQUIPMENT.

---

## UNDERSTAND SIGNAL WORDS

Note the use of the signal words **DANGER**, **WARNING** and **CAUTION** with the safety messages. The appropriate signal word for each has been selected using the following guidelines:

**DANGER:** Indicates an imminently hazardous situation that, if not avoided, will result in death or serious injury. This signal word is to be limited to the most extreme situations typically for machine components which, for functional purposes, cannot be guarded.

**WARNING:** Indicates a potentially hazardous situation that, if not avoided, could result in death or serious injury, and includes hazards that are exposed when guards are removed. It may also be used to alert against unsafe practices.

**CAUTION:** Indicates a potentially hazardous situation that, if not avoided, may result in minor or moderate injury. It may also be used to alert against unsafe practices.

If you have questions not answered in this manual or require additional copies or the manual is damaged, please contact your dealer or the manufacturer directly.

---

## IMPORTANT SAFETY INFORMATION!

Read this manual, and the manual for your tractor, before assembly or operating, to acquaint yourself with the machines. It is the implement owner's responsibility, if this machine is used by any person other than yourself, is loaned or rented, to make certain that the operator, prior to operating:

1. Reads and understands the operator's manuals.
2. Is instructed in safe and proper use.



The use of this equipment is subject to certain hazards which cannot be protected against by mechanical means or product design. All operators of this equipment must read and understand this entire manual, paying particular attention to safety and operating instructions, prior to using. If there is something in this manual you do not understand, ask your supervisor, or your dealer, to explain it to you.

# SAFETY INSTRUCTIONS (continued)



## EQUIPMENT SAFETY GUIDELINES



Safety of the operator is one of the main concerns in designing and developing a new piece of equipment. Designers and manufacturers build in as many safety features as possible. However, every year many accidents occur which could have been avoided by a few seconds of thought and a more careful approach to handling equipment. You, the operator, can avoid many accidents by observing the following precautions in this section. To avoid personal injury, study the following precautions and insist those working with you, or for you, follow them.



In order to provide a better view, certain photographs or illustrations in this manual may show an assembly with a safety shield removed. However, equipment should never be operated in this condition. Keep all shields in place. If shield removal becomes necessary for repairs, replace the shield prior to use.



Replace any CAUTION, WARNING, DANGER or instruction safety sign that is not readable or is missing. Location of such safety signs is indicated in this booklet.



Never use alcoholic beverages or drugs which can hinder alertness or coordination while operating this equipment. Consult your doctor about operating this machine while taking prescription medications.



Review the safety instructions with all users annually.



This equipment is dangerous to children and persons unfamiliar with its operation. The operator should be a responsible adult familiar with farm machinery and trained in this equipment's operations. **Do not allow persons to operate or assemble this unit until they have read this manual and have developed a thorough understanding of the safety precautions and of how it works.**



To prevent injury or death, use a power unit equipped with a Roll-Over Protective System (ROPS). Do not paint over, remove or deface any safety signs or warning signs on your equipment. Observe all safety signs and practice the instruction on them.



Never exceed the limits of a piece of machinery. If its ability to do a job, or to do so safely, is in question – **DON'T TRY IT.**



Do not modify the equipment in any way. Unauthorized modification may impair the function and/or safety and could affect the life of the equipment.



In addition to the design and configuration of this implement, including Safety Signs and Safety Equipment, hazard control and accident prevention are dependent upon the awareness, concern, prudence, and proper training of personnel involved in the operation, transport, maintenance, and storage of the machine. Refer also to Safety Messages and Operation Instructions in each of the appropriate sections of the power unit and implement manuals. Pay close attention to the Safety Signs affixed to the power unit and the implement.

# SAFETY INSTRUCTIONS (continued)



## SAFETY SIGNS

Keep safety signs clean and legible at all times.

Replace safety signs that are missing or have become illegible.

Replaced parts that displayed a safety sign should also display the current sign.

Safety signs are available from your Distributor or Dealer Parts Department or the factory.

### **How to Install Safety Signs:**

Be sure that the installation area is clean and dry. Be sure temperature is above 50°F (10°C).

Decide on the exact position before you remove the backing paper.

Remove the smallest portion of the split backing paper. Align the sign over the specified area and carefully press the small portion with the exposed sticky backing in place.

Slowly peel back the remaining paper and carefully smooth the remaining portion of the sign in place. Small air pockets can be pierced with a pin and smoothed out using the piece of sign backing paper.



## SAFETY TRAINING

 Safety is a primary concern in the design and manufacture of our products. Unfortunately, our efforts to provide safe equipment can be wiped out by a single careless act of an operator. It is the operator's responsibility to read and understand ALL Safety and Operating instructions in the manual and to follow these. Accidents can be avoided.

 In addition to the design and configuration of equipment, hazard control and accident prevention are dependent upon the awareness, concern, prudence and proper training of personnel involved in the operation, transport, maintenance and storage of equipment.

 Read this manual, and the manual for your skid steer, before assembly or operating, to acquaint yourself with the machines. It is the owner's responsibility, if this machine is used by any person other than yourself, is loaned or rented, to make certain that the operator, prior to operating:

1. Reads and understands the operator's manuals.
2. Is instructed in safe and proper use.

 Know your controls and how to stop skid steer, engine, and attachment quickly in an emergency. Read this manual and the one provided with your skid steer.

 Train all new personnel and review instructions frequently with existing workers. A person who has not read and understood all operating and safety instructions is not qualified to operate the machine. An untrained operator exposes himself and bystanders to possible serious injury or death.

 Do not allow children to operate this machine.

# SAFETY INSTRUCTIONS (continued)



## STARTING AND STOPPING SAFETY



Be certain the skid steer is in neutral or park position before starting engine.



Do not leave the skid steer and attachment unattended with the engine running.



Mixer operating power is supplied from skid steer hydraulic system. Refer to your skid steer manual for hydraulic engagement and disengagement instructions. Know how to stop skid steer and mixer quickly in case of an emergency.



Mixer should be lifted off the ground before engaging hydraulic power and be sure that no one is near the machine. When engaging hydraulic system, the RPM should always be low.



Take all possible precautions when leaving unit unattended: Disengage hydraulic power, set parking brake, stop engine and remove key from ignition. Park in level area.



## OPERATIONAL SAFETY



The use of this equipment is subject to certain hazards which cannot be protected against by mechanical means or product design. All operators of this equipment must read and understand this entire manual, paying particular attention to safety and operating instructions, prior to using. If there is something in this manual you do not understand, ask your supervisor, or your dealer, to explain it to you.



Keep all helpers and bystanders at least twenty (20) feet from an operating mixer. Only properly trained people should operate this machine.



Never place hands or body on mixer with mixer drum rotating or before you are sure all motion has stopped. Stay clear of all moving parts.



Do not walk or work under a raised mixer attachment unless it is securely blocked or held in position. Do not depend on the hydraulic system to hold the mixer attachment in place.



A heavy load can cause instability of the skid steer. Use extreme care during travel. Slow down on turns and watch out for bumps. The skid steer may need additional counter-weights to counter-balance the weight of the mixer.



Never use alcoholic beverages or drugs which can hinder alertness or coordination while operating this equipment. Consult your doctor about operating this machine while taking prescription medications.













Never permit any person other than the operator to ride or board the skid steer or mixer attachment at any time. **ALLOW NO RIDERS!**

# SAFETY INSTRUCTIONS (continued)



## OPERATIONAL SAFETY (continued)

-  Before you operate the mixer, check over all pins, bolts and connections to be sure all are securely in place. Replace any damaged or worn parts immediately.
  
-  Never place hands or hand held tools (shovel) into the mixer drum while it is turning. It could catch on the mixer paddles and whip around, possibly injuring the operator or helper.
  
-  Use extreme care and maintain minimum ground speed when transporting on hillside, over rough ground and when operating close to ditches or fences. Be careful when turning sharp corners.
  
-  Make certain that the work area around the machine is clear of debris and obstructions to prevent tripping and/or falling onto the machine.
  
-  DO NOT overreach while working with the mixer. Keep proper footing and balance at all times when loading or unloading the mixer.
  
-  Most accidents occur because of neglect or carelessness. Keep all helpers and bystanders at a safe distance. Keep all unauthorized and untrained people away from the machine at all time.
  
-  Always stop the power unit, set brake, shut off the engine, remove the ignition key, lower implement to the ground and allow rotating mixer drum to come to a complete stop before dismounting. Never leave equipment unattended with the power unit running. NEVER let the mixer run unattended even for a brief moment.
  
-  Take all possible precautions when leaving unit unattended: Disengage hydraulic power, set parking brake, stop engine and remove key from ignition. Park in level area.
  
-  Beware of low electrical wires when mixer is raised. Serious injury or death can result if contact is made. Beware of lift clearance when raising mixer to maximum height.
  
-  Keep alert and watch the rear as well as the front when working with the mixer.
  
-  When maneuvering close to buildings or passing through narrow areas, be sure to allow sufficient clearance for the skid steer and attachment. Drive slowly.



# SAFETY INSTRUCTIONS (continued)



## OPERATIONAL SAFETY (continued)



Operate loader from operator's seat only. Remain at controls until operating cycle is complete.



Stop loader gradually when lowering or lifting loads. Operate loader controls smoothly, avoid jerky operation.



Allow for additional length of loader arms and attachment on skid steer while turning.



Be sure that people, livestock, or pets are not standing near the machine while operating.



Avoid excessive speed during operation.



Always drive down slopes; never across the face. Avoid operation on steep slopes. Slow down on sharp turns and slopes to prevent tipping and/or loss of control. Avoid slopes when surface is wet, slippery grass or soil.



ALWAYS lower loader and mixer attachment to the ground or block securely before performing any maintenance work.



Stay alert for holes, rocks and roots in the terrain and other hidden hazards. Keep away from drop-offs.



Use extreme care and maintain minimum ground speed when transporting on hillside, over rough ground and when operating close to ditches or fences. Be careful when turning sharp corners.



Reduce speed on slopes and sharp turns to minimize tipping or loss of control. Be careful when changing directions on slopes. Do not start or stop suddenly on slopes. Avoid operation on steep slopes.



Before operating equipment: if you have any questions regarding the proper assembly or operation, contact your dealer or representative.

# SAFETY INSTRUCTIONS (continued)





## MAINTENANCE SAFETY

Good maintenance is your responsibility. Poor maintenance is an invitation to trouble.

 Keep all persons away from operator control area while performing adjustments, service, or maintenance.

 Inspect the entire machine periodically. Look for loose fasteners, worn or broken parts, and worn driveline parts and/or shields. Make sure all pins have cotter pins and washers. Serious injury may occur from not maintaining this machine in good working order.

 Before working on this machine, drive to a level area, relieve hydraulic pressure, lower implement (or if working underneath, raise and block securely), shut off the engine, set the brakes, and remove the ignition keys.

 Never work under equipment unless it is blocked securely. Never depend on hydraulic system to keep implement in raised position.

 Always use personal protection devices such as eye, hand and hearing protectors, when performing any service or maintenance.

 Periodically tighten all bolts, nuts and screws and check that all cotter pins are properly installed to ensure unit is in a safe condition.

 When completing a maintenance or service function, make sure all safety shields and devices are installed before placing unit in service.

 Always use two people to handle heavy, unwieldy components during assembly, installation, removal, or moving the mixer attachment

 Openings in the skin and minor cuts are susceptible to infection from hydraulic fluid. If injured by escaping hydraulic fluid, see a doctor at once. Gangrene and death can result. Without immediate medical treatment, serious infection and reactions can occur.

 Check to ensure all safety signs are installed and in good condition. (See safety sign section for location drawing.)

# SAFETY INSTRUCTIONS (continued)



## TRANSPORT SAFETY



Comply with state and local laws governing highway safety and movement of machinery on public roads.



The use of flashing amber lights is acceptable in most localities. However, some localities prohibit their use. Local laws should be checked for all highway lighting and marking requirements.



Always be sure the attachment is in the proper slightly raised position for transport.



Reduce speed when transporting mounted attachments to avoid bouncing and momentary loss of steering control.



Plan your route to avoid heavy traffic.



Do not drink and drive!



Never allow riders on either power unit or attachment. Falling off can kill.



Be a safe and courteous driver. Always yield to oncoming traffic in all situations, including narrow bridges, intersections, etc.



## STORAGE SAFETY



Store the unit in an area away from human activity. Do not permit children to play on or around the stored unit.



Make sure all parked machines are on a hard, level surface and engage all safety devices. Storage location should be level and solid to make connecting and unconnecting to skid steer easy.



If blocking is used, make sure it is solid and secure before leaving area.

# SAFETY SIGNS

**⚠ WARNING**

TO AVOID SERIOUS INJURY OR DEATH:

- Read Operator's Manual before operating, servicing or repairing equipment. Follow all safety rules and instructions. (Manuals are available from your selling dealer.)
- Never allow riders.
- Keep bystanders away from equipment during operation.
- Operate from operator's seat only.
- Keep all shields in place and in good condition.
- Lower equipment to ground, stop engine, remove key and set brake before dismantling power unit.
- Never allow children or untrained persons to operate equipment.

FAILURE TO FOLLOW THESE INSTRUCTIONS CAN RESULT IN INJURY OR DEATH.

101289

**⚠ WARNING**



**HIGH-PRESSURE FLUID HAZARD**

To prevent serious injury or death:

- Relieve pressure on system before repairing or adjusting or disconnecting.
- Wear proper hand and eye protection when searching for leaks. Use wood or cardboard instead of hands.
- Keep all components in good repair.

SW700

**HYDRAULIC MIXER  
OPERATING INSTRUCTIONS**

1. Follow and observe all safety, operational, and service instructions in operating manual supplied with this machine.
2. Make sure this machine is securely attached to skid steer - lock levers locked.
3. Drum rotates in one direction only. If drum will not rotate when control valve on mixer is activated, reverse hydraulic remote control valve in skid steer or switch hoses.  
Note: This machine utilizes up to 8 GPM hydraulic flow at maximum drum speed. Excess flow is bypassed back to skid steer remote.
4. Adjust drum speed by rotating handle on control valve. Proper speed should provide a folding/ blending action.
5. Drum may be rotating or stopped when dumping.
6. Stand legs can be positioned inward during operation for close work around forms, etc.
7. Drum should be tipped up approximately 20° (back of frame vertical) when mixing.
8. Follow instructions on premix or cement bag for proper cement, sand, aggregate, and water ratios for desired strength or consistency.
9. Drum should be thoroughly rinsed after use.

101307

**⚠ WARNING**

**Stand clear**

101027

**BE CAREFUL!** Use a clean, damp cloth to clean safety decals. Avoid spraying to close to decals when using a pressure washer; high-pressure water can enter through very small scratches or under edges of decals causing them to peel or come off.

**REMEMBER:** If Safety Signs have been damaged, removed, become illegible or parts replaced without Signs, new Safety Signs must be applied. New Safety Signs are available from your authorized distributor or factory.

# INSTRUCTIONS

---

## SKID STEER REQUIREMENTS AND PREPARATION

---

The Model 590 Hydraulic Mixer is designed to fit skid steer units with the “Universal” (Bobcat) style quick-attach loaders. This mixer allows you to mix, transport and place cement or concrete any place your skid steer unit can go.

Remove the bucket from your Skid Steer unit. Check the loader arms and cylinders to make sure they are in good working order. Lubricate all loader pivot points. Check all bolts to make sure they are in place and tight.

Be sure the skid steer hydraulic oil and filter have been serviced according to the skid steer manufacturer's recommendations.

### CAUTION

Be sure your skid steer is in good condition. Read all the safety precautions and make sure all loader operators are familiar with the safety rules of operation.

The Model 590 mixer requires a skid steer to be of sufficient size to handle a loaded mixer drum. Five cubic feet of concrete weighs 685 lbs. and the Model 590 mixer weighs 395 lbs. for a total weight of 1,080 lbs. Always be sure your skid steer is properly counterbalanced for a safe operation.  **It is a good practice to use a loader with an equal or greater SAE operating load capacity.**

## ASSEMBLY

---

This unit is shipped almost completely assembled. Carefully follow instructions for final assembly.

Before attempting assembly check the following items. Having all the needed parts and equipment readily at hand will speed up your assembly task and will make the job as safe as possible.

- Check for fasteners and pins that were shipped with the mixer. All hardware coming from the factory has been installed in the location where it will be used. If a part or fastener is temporarily removed for assembly reasons, remember where it goes. Keep the parts separated.
- Have a minimum of 2 people at hand during assembly.

This unit is shipped almost completely assembled. Refer to the Safety Precautions and Warnings on the front cover and in the Safety Section of this manual prior to working on the machine.

**NOTE:** The gearbox is shipped **WITHOUT** lubricant, so it will be necessary to fill it before use. With the gearbox in a level position, fill to the side inspection hole with a good 90 wt. gear lubricant. Gearbox holds 86 fluid oz. Check often and add lubricant if necessary.

### CAUTION

Do not operate this equipment without shields properly installed. This is for your protection, and the manufacturer recommends the use of these shields at all times while operating this attachment.

Refer to the “exploded view” of the skid steer mounted hydraulic mixer on page 17 of this manual. Become familiar with the relationship of the various components and parts shown.

Connect the mixer mount frame to the “universal” quick-attach plate on your skid steer loader. Flip the spring loaded latch pins to the “latch lock” position and check to see they are properly latched. (See next page.)

Install the proper hydraulic quick-connect couplers on the ends of the hydraulic hoses. Use a good grade liquid thread sealant. **Do not use thread tape, as this can contaminate the hydraulic system.**

Route the hose to avoid pinching or chafing the hose. Use nylon ties or tape to fasten hose on loader arm to keep it in place. Operate the roll function through its full range and make sure the hose routing and length is adequate for your particular make and model skid loader.

The operator is responsible for the safe operation of this mixer. The operator must be properly trained. Operators should be familiar with the mixer and power unit and all safety practices before starting operation. Read the safety rules and safety signs on pages 3-11.

# INSTRUCTIONS (continued)

## SKID STEER MIXER INSTALLATION / REMOVAL

### TO INSTALL:

1. Read and understand skid steer manufacturer's instructions for installing attachments.
2. The quick attach coupler handles should be in the unlocked position with lock pins retracted, Figure 1.

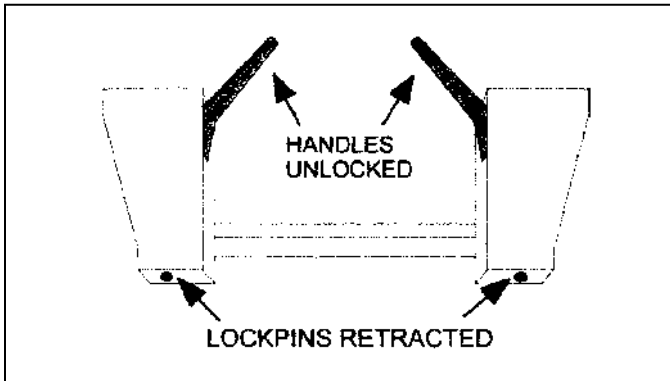

**Figure 1** – Quick Attach Coupler Handles – Unlocked

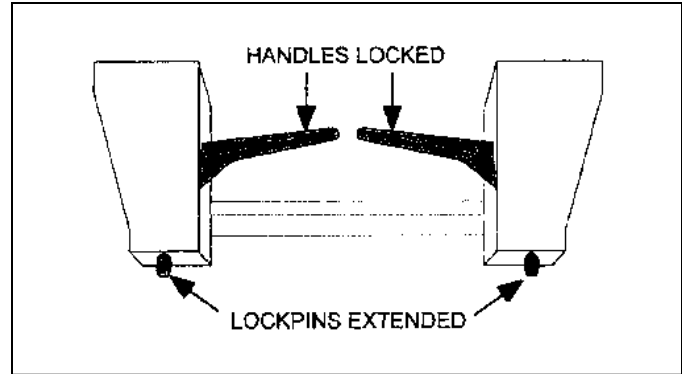

**Figure 2** – Attachment Coupler Handles – Locked



### WARNING

Attachment coupler handles must always be rotated to LOCK POSITION to prevent coupler latch from disengaging and attachment from falling off.

3. Enter the prime mover. Fasten seatbelt, start engine. Disengage the parking brake.
4. Follow the attaching procedure in the prime mover owner's manual. Align the attachment mechanism with the mounting on the mixer, attach to the prime mover or loader.
5. Engage the parking brake and shut down the prime mover. Be sure to relieve pressure to the auxiliary hydraulic lines.
6. Unfasten safety restraints and exit the prime mover.
7. Make sure the hydraulic couplers are clean. Connect the hydraulic lines to the prime mover. Twist the collar of the quick couplers one-quarter turn to secure hydraulic connections.
8. Engage the latching mechanism to secure attachment to loader. The lockpins must be completely extended and secured into the retaining slots provided on the attachment. Figure 2.
9. Re-enter the prime mover. Fasten seatbelt and restart engine.
10. Carefully raise the loader and cycle the rollback/tilt cylinders to check clearances and to ensure that the attachment is securely mounted.
11. With the skid steer engine at a fast idle, engage the hydraulic lever to allow hydraulic oil to flow to the mixer. Allow the mixer to operate for a few minutes to work the air out of the lines.

### REMOVING THE MIXER FROM SKID STEER:



### WARNING

- Serious injury or death may result from disengaging the attachment when the attachment is in an unstable position. Place the attachment in a stable position before disengaging.
  - Hoses for the attachment must be disconnected before the quick attach is disengaged. Pulling the attachment with the hoses could result in damage to the prime mover or the attachment.
1. If possible, find a level solid location to place the attachment. This makes it easier to disconnect and to re-connect.
  2. Lower the attachment to the ground.
  3. Engage the parking brake and shut down the prime mover. Be sure to relieve pressure to the hydraulic lines.
  4. Exit prime mover.
  5. Disconnect the attachment hydraulic lines from the prime mover. Connect quick couplers together to keep clean.
  6. Disengage attachment-locking mechanism (mechanical type).
  7. Enter and start the prime mover.
  8. Disengage attachment-locking mechanism (hydraulic type).
  9. Disengage the parking brake, and back away from the attachment.

# OPERATING INSTRUCTIONS

## OPERATION

For best mixing, the drum should be inclined upward 10° to 15° (see Fig. 3). Add some water before cement, sand or aggregate is put in drum.

**NOTE:** ONLY LOAD MIXER WHILE DRUM IS TURNING. DO NOT OVERLOAD THE MIXER.

The amount of water used per sack of cement is the key to quality concrete. Use 5, 6 or 7 gallons of water per sack of cement with dry sand and dry aggregate depending on the strength of concrete required. The less water you use the stronger the concrete will be and we suggest that you deduct approximately 1 gallon if the material is wet and approximately 1½ gallons if very wet.

**NOTE:** See next page for suggested Mix Instructions.

We suggest mixing a trial batch to determine exact proportions you will want to use. If too wet, add more sand and aggregate. If too stiff, reduce the amount of sand and aggregate in the next batch, but **never** add more water to a batch once you have established the correct proportions to use.

After concrete is poured, it is screeded or struck off with a straight edge like a 2 x 4 and should then be floated to smooth it. Further troweling or finishing should be delayed until the water sheen has disappeared from the surface. The concrete should be cured at least five days. To prevent evaporation of mixing water, cover with burlap or straw and keep damp or cover with a vapor sealing material to seal in the water and prevent evaporation.

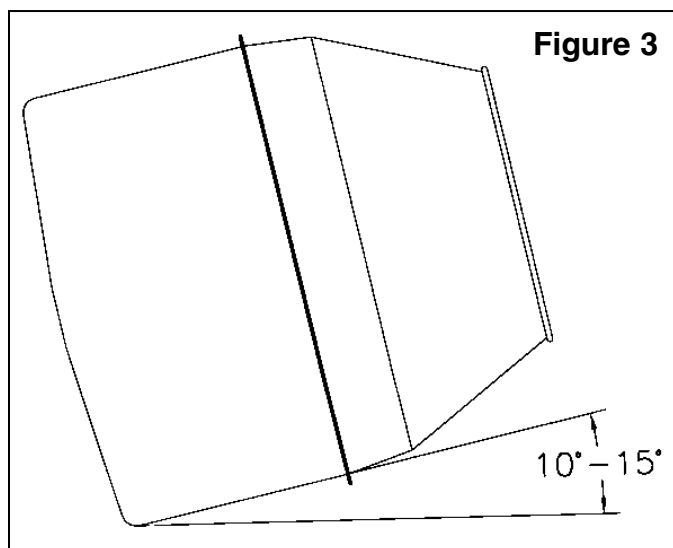

## WARNING

**Never place hands or hand held tools (shovel) into the mixer drum while it is turning. It could catch on the mixer paddles and whip around, possibly injuring the operator.**

The speed of the mixer drum can be adjusted with the handle on the flow control valve.

**NOTE:** If the legs of the SS-590 Mixer interfere with dumping the concrete, they can easily be turned 90° (facing each other) placing them out of the way.

## MAINTENANCE

### WARNING

**Before servicing the machine, engage the parking brake or place the transmission in "Park," shut off the skid steer and remove the key.**

**Keep clear of rotating parts; stay on seat until all motion has stopped.**

**Do not get under machine to make adjustments without securely blocking implement first.**

If work is required while the mixer is attached to the loader, the mixer must be blocked securely. NEVER trust the loader's hydraulic system.

The Model 590 Mixer is almost maintenance free. Just check the gearbox for proper oil level every 40 hours of operation and keep the unit clean.

Gearbox holds 86 fluid oz. of SAE 90w gear lube.

After mixing concrete, or any material that clings to the side of the drum, be sure to clean thoroughly when finished. In mixing concrete, if there are lapses between batches, it is a good idea to add some water and rinse so that the concrete will not set in the drum.

Carefully check and replace any worn or damaged parts.

# MIXING INSTRUCTIONS

## **SAND MIX**

---

For overlaying concrete and as a bedding mix and joint grout for flag-stone, slate or brick walkways and patios. For applications 1/2 inch to 2 inches (50 mm) in thickness.

### **PREPARATION:**

When repairing concrete, square up the area to be patched. Remove all loose and foreign material. Clean the surface thoroughly. Dampen the area to be repaired just prior to applying Sand Mix.

For thicknesses less than 2 inches and toppings, use: 1 part of Portland Cement with 3-4 parts of concrete sand or general purpose sand,

### **MIXING:**

Place material into mixer. If too stiff, add more water a little at a time. **AVOID A SOUPY MIX.** Excess water reduces strength and durability and can cause cracking. In cold weather use warm water to accelerate the set. Use cold water to slow the set in hot weather.

### **FINISHING:**

Level with a screed and allow the bleed water to evaporate. Use a float to remove surface imperfections and trowel to a smooth finish. For a rougher surface, use a broom. Finishing cementitious materials too early, or over-working the materials can cause dusting, cracking, scaling and a weak surface.

### **CURING:**

Curing means maintaining proper moisture and temperature, Account for local environmental conditions when selecting the curing method. High heat, low humidity or wind will increase the evaporation of water. Keep the surface damp, using a sprinkler, wet burlap, or cover with plastic for several days as needed. In cold weather adequately cover and keep from freezing for a minimum of 24 hours.

## **PREPARED CONCRETE MIX**

---

SAKRETE® Portland Cement Type I-II is used to make concrete where 2-inch thickness or more is needed to build or repair walks, floors, footings, patios, setting posts and poles.

- You will need approximately seven (7) gallons of water
- 6-80 lb. Bags of pre-mix concrete

- Put five (5) gallons of water into the mixing drum
- Add four (4) 80 lb. Bags of pre-mix concrete
- NOTE: Mixture will be very sloppy
- Slowly add the two remaining bags of 80 lb. Pre-mix concrete
- Add water slowly to obtain desired consistency

WILL YIELD 4.5 CU. FT. OF CONCRETE

## **GENERAL PURPOSE CONCRETE USING SAND & GRAVEL**

---

Use the following mix proportions to make general purpose concrete:

Mix together

- 1 part cement (This bag contains 94 lbs. or 1 cu. ft.).
- 2 parts concrete sand or general purpose sand (160-180 lbs.).
- 3 parts gravel or stone (240-300 lbs., 3/4" recommended).

Add approximately 6 gallons of clean water. Mix until uniform, workable consistency.

Concrete will remain workable for at least 1 hour.

To aid curing, spray surface lightly with water 2 or 3 times per day for 3 days.

One 94 lb. bag of Portland Cement makes 4.5 cubic feet of concrete.

- Use an 8-1/2 x 12" square nose shovel
- Portland cement, gravel (or round stone), and masonry sand
- Put five (5) gallons of water into the mixing drum
- Add 18 shovels full of gravel (or round stone) – 3/4" recommended
- Add six (6) shovels full of Portland cement
- Slowly add 12 shovels full of masonry sand
- **NOTE: WATER WILL VARY ACCORDING TO MOISTURE CONTENT OF SAND & GRAVEL**
- Add water (if needed) slowly to obtain desired consistency

WILL YIELD 4.5 CU. FT. OF CONCRETE



# TROUBLE-SHOOTING

---

## **PROBLEM: MIXER WILL NOT TURN**

### POSSIBLE SOLUTIONS:

- Remote quick-connect couplers not properly connected. Mixer is designed to turn in only one direction. Reverse hydraulic control lever or switch hoses.
- Flow control valve is in “off” position.

## **PROBLEM: MIXER SHAKES EXCESSIVELY**

### POSSIBLE SOLUTIONS:

- Mix too dry and has formed a clump – add water.
- Material has large chunks – break up material before putting in mixer drum.

## **PROBLEM: MIXER ROTATES TOO SLOW**

### POSSIBLE SOLUTIONS:

- Flow control valve needs adjusting.
- Hydraulic system may not be delivering its rated volume of oil due to wear. Hydraulic pump may need to be repaired.
- Pinched hydraulic hose.
- Hydraulic oil flow problems on skid steer.

## **PROBLEM: MIXER STALLS**

### POSSIBLE SOLUTIONS:

- Hydraulic system may not be supplying rated pressure (usually 1850 to 3000 PSI). Consult your dealer.
- Too much load for mixer – reduce amount of material.

## **PROBLEM: HYDRAULIC OIL OVERHEATS**

### POSSIBLE SOLUTIONS:

- Hydraulic oil level in skid steer reservoir may be low.
- Hydraulic oil or oil filter in skid steer may be dirty. Change oil and filter according to manufacturer’s recommendations.
- Hydraulic oil reservoir of skid steer may be small. Allow time for oil to cool down.

## **PROBLEM: HYDRAULIC HOSE FAILURE**

### POSSIBLE SOLUTIONS:

- Hydraulic relief pressure setting is very high and may cause hydraulic hose failure.
- Hoses are worn or frayed – replace hose.
- Hose rating may be too low for hydraulic system pressure. Replace with higher rated hoses.
- Hose being pinched – reroute hose and refasten.

## **PROBLEM: GEARBOX OVERHEATING**

### POSSIBLE SOLUTIONS:

- Low on lubricant – fill to proper level.
- Improper type lubricant – replace with proper lubricant.

# MODEL SS-590 MIXER PARTS LIST

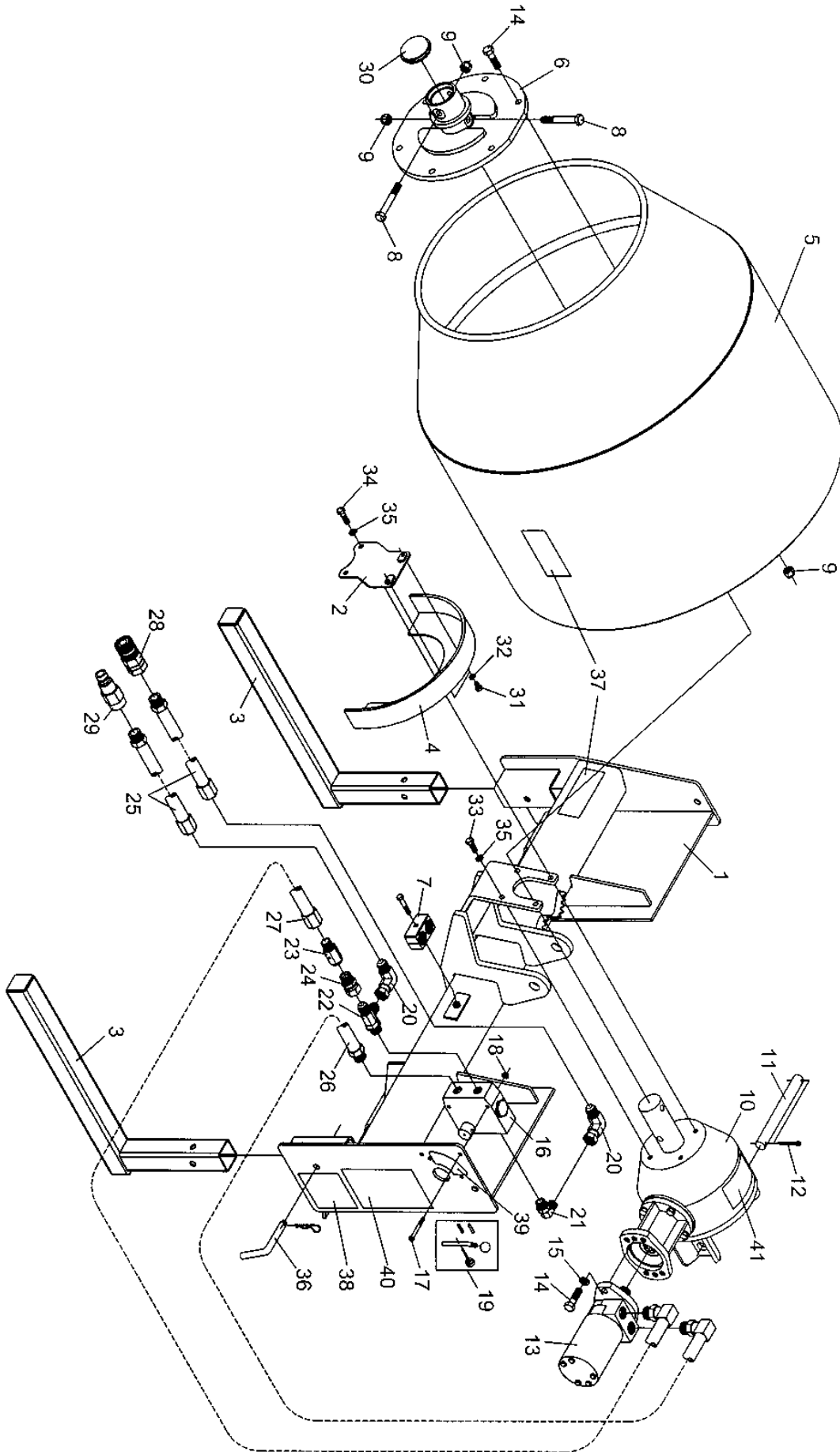

## MODEL SS-590 MIXER PARTS VIEW

Ref. No.	Part No.	Description	No. Req'd.
1	780965	Main Frame Weldment (SS-590 Mixer)	1
2	780977	Guard Support Weldment	1
3	780975	Mixer Leg Weldment	2
4	780970	Guard Weldment	1
5	780945	Drum Weldment	1
6	780951	Hub Weldment	1
7	2505586	Hose Clamp Assembly	1
8	2503264	Bolt 1/2"-13NC x 3 1/2" Hex Head Gr. 5	2
9	2500039	Nut 1/2"-13NC Nylock Hex	8
10	706403	Gearbox w/Input Flange Assembly	1
11	706096	Gearbox Pin	1
12	706097	Cotter Pin 3/16" x 2"	2
13	2505704	Hydraulic Motor (Parker)	1
14	2503265	Bolt 1/2"-13NC x 1 3/4" Hex Head Gr. 5	8
15	2502002	Washer 1/2" Springlock	2
16	2505583	Valve, Flow Control (Prince)	1
17	2503249	Bolt 1/4"-20NC x 2 1/4" Hex Head Gr. 2	2
18	2500008	Nut 1/4"-20NC Whix Flange Hex	2
19	2505590	Handle Hardware Kit for Flow Control Valve	1
20	2505736	Elbow, 90° Swivel 3/4"	2
21	2505737	Elbow, 90° Adjustable 3/4"	1
22	2505738	Tee, Adjustable 3/4"	1
23	2505757	Valve, Check	1
24	2505758	Connector 3/4"	1
25	2505739	Hose, Hydraulic 1/2" ID x 120"	2
26	2505740	Hose, Hydraulic 1/2" ID x 24" w/90° Fitting	1
27	2505741	Hose, Hydraulic 1/2" ID x 20" w/90° Fitting	1
28	2505689	SAE Coupling 1/2" Female - 3/4"16 ORB	1
29	2505688	SAE Coupling 1/2" Male - 3/4"-16 ORB	1
30	2506024	Dust Cap	1
31	2503105	Bolt 5/16"-18NC x 1/2" Hex Head Gr. 2	2
32	2502011	Washer 5/16" Springlock	2
33	2503011	Bolt 3/8"-16NC x 1" Hex Head Gr. 2	2
34	2503020	Bolt 3/8"-16NC x 1 1/4" Hex Head Gr. 5	2
35	2502008	Washer 3/8" Springlock	4
36	341857	Shift Pin w/Hair Clip Pin	2
37	101027	Safety Sign - Warning (Stand Clear)	2
38	101122	Safety Sign - Warning (Hi-Pressure)	1
39	101197	Decal - Speed Control	1
40	101307	Safety Sign - Mixer Instructions	1
41	101188	Decal - Gearbox Notice	1

# HYDRAULIC MIXER GEARBOX PARTS LIST

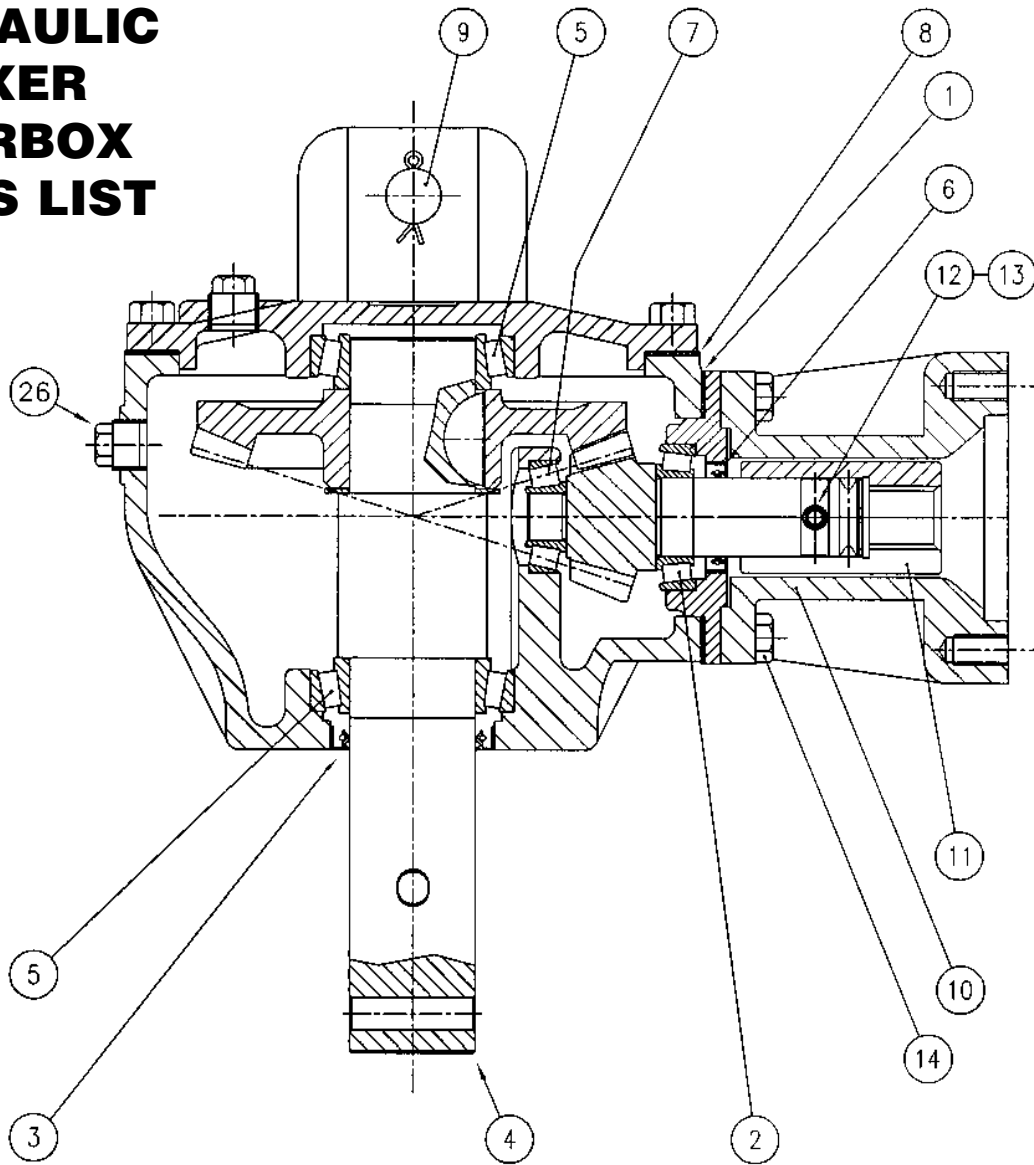

Ref. No.	Worksaver Part No.	Description	Com. Code No.	No. Req'd.
	706403	Complete Gearbox w/Flange Assembly	9.196.004.10	1
1	706407	Gasket Kit (81.5 x 118)	0.196.7300.00	1
2	706409	Roller Bearing LM67048 - LM67010	8.0.9.02531	1
3	706410	Dust Lip 50.8 x 66.62 x 7.92	8.7.1.02529	1
4	Not Available	Output Shaft	0.196.3001.00	1
5	706413	Roller Bearing LM104949 - LM104911	8.0.9.02532	2
6	706414	Dust Lip 31.75 x 44.5 x 7.92	8.7.1.02530	1
7	706417	Roller Bearing LM11910 - LM11949	8.0.9.02533	1
8	706418	Gasket Kit (190 x 224.5)	0.196.7200.00	1
9	706419	Pivot Shaft	0.196.3000.00	1
	702141	Flange Assembly (Items #10 - #14)	A.196.502	1
10	Not Available Separately	Extension		1
11	Not Available Separately	Bushing Grooved		1
12	Not Available Separately	Pin 6 x 45 DIN1481		1
13	Not Available Separately	Pin 10 x 45 DIN1481		1
14	Not Available Separately	Bolt M10 x 40 Hex Head Gr. 8.8		4

# MODEL SS-590 MIXER SPECIFICATIONS

Drum Capacity . . . . .	Eleven (11) cu./ft.
Mix Capacity . . . . .	Five (5) cu./ft. (1 bag mix)
Drum opening (in/mm) . . . . .	20 (508)
Overall drum length (in/mm) . . . . .	32 (813)
Diameter of drum (in/mm) . . . . .	30 (762)
Drum construction . . . . .	Welded Steel
Drive system . . . . .	Hydraulic
Hydraulic requirements . . . . .	8 GPM (min)
Drum drive . . . . .	Gearbox direct
Gearbox oil capacity . . . . .	86 fluid oz.
Gearbox oil . . . . .	SAE 90w
Drive ratio (gearbox) . . . . .	3.18-1
Shield drum drive . . . . .	Standard
Bearing type . . . . .	Tapered roller
Hydraulic motor . . . . .	Standard
Mounting . . . . .	“Universal style” skid steer
Parking stands . . . . .	Standard
Weight (lb./kg) . . . . .	395 (180)
Product Computer Number . . . . .	780950

# **SAFETY REQUIREMENTS**

**AVOID ACCIDENTS BY FOLLOWING ALL OF THE SAFETY REQUIREMENTS LISTED BELOW.**

- Machinery should be operated only by those who are responsible and are authorized to do so.
- Stop the engine, lower all equipment, lock the brakes, and remove the ignition key before dismounting from the skid steer.
- Never stand between skid steer and attachment while skid steer is being connected to the attachment.
- Loose fitting clothing should not be worn, to avoid catching on various parts.
- Detach attachment in area where children normally do not play.
- When performing adjustments or maintenance on an attachment, first lower it to the ground or block it securely at a workable height.
- Only a qualified operator should be permitted on skid steer when in operation; no riders allowed.
- Make certain everyone is in the clear before starting tractor or raising or lowering equipment.
- Operate the skid steer and attachment only while seated in the driver's seat.
- Reduce speed when transporting mounted attachments to avoid bouncing and momentary loss of steering control.
- A heavy load can cause instability of the skid steer. Use extreme care during road travel. Slow down on turns and watch out for bumps. Skid steer may need front counterweights to counter-balance the weight of the attachment.
- Reduce speed on hillsides or curves so there is no danger of tipping.
- Avoid driving too close to the edge of ditches or drop offs.
- Do not transport implement on public roads without reflectors and slow moving vehicle emblem in daylight and with approved warning lights at night and other periods of poor visibility.
- Keep work area clear of all debris. Never assume an area is clear. **ALWAYS CHECK.**
- Check to make certain there are no buried utilities in the work area before starting work.
- Keep alert and watch the front as well as the rear when working with the attachment.

## **OWNER'S/ OPERATOR'S MANUAL**

**MODEL NO.  
SS-590**

JUNE 2014

# **SS-590 MIXER**

**WHEN ORDERING REPAIR PARTS,  
ALWAYS GIVE THE  
FOLLOWING INFORMATION:**

1. PART NUMBER
2. PART DESCRIPTION
3. MODEL NUMBER
4. NAME OF ITEM

**MAKE EVERY DAY  
A HOLIDAY  
FROM ACCIDENTS!**

**WORKSAVER, INC.**

P.O. BOX 100 LITCHFIELD, IL 62056-0100 (217) 324-5973  
WEB: <http://www.worksaver.com> E-MAIL: [sales@worksaver.com](mailto:sales@worksaver.com)