

# OWNER'S/ OPERATOR'S MANUAL

## MODEL NO.'s

**FLBS-2200**

**FLBS-3000**

**FLBS-330**

**FLBS-340**

**FLBS-432**

**FLBS-449**

**FLBS-6000**

### **CAUTION**

For Safe Operation  
Read Rules And  
Instructions Carefully

SI NO LEEINGLES, PIDA AYUDA  
A AIGUIEN QUE SI LO LEA  
PARA QUE LE TRADUZCA LAS  
MEDIDAS DE SEGURIDAD.

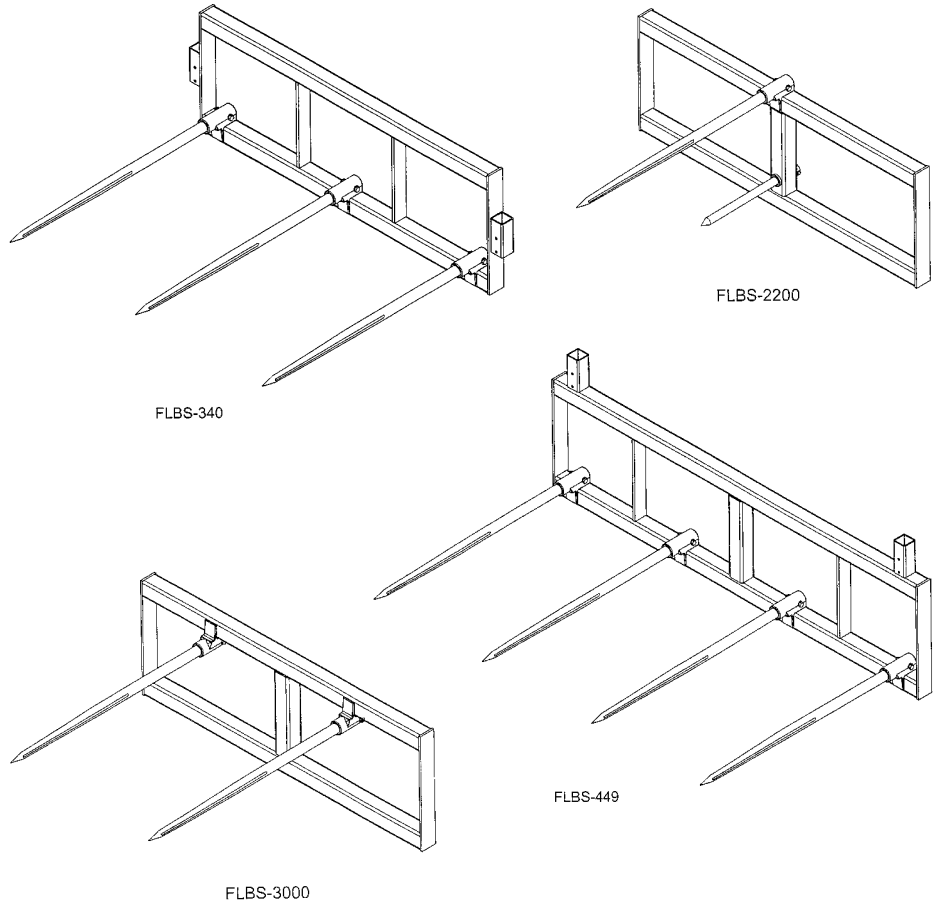

## **BALE SPEAR ATTACHMENTS**

**Safety Instructions**  
**Assembly & Mounting**  
**Operating Instructions**

**Maintenance**  
**Repair Parts**

### **CAUTION**

#### **THE FOLLOWING SAFETY PRECAUTIONS SHOULD BE THOROUGHLY UNDERSTOOD BEFORE ATTEMPTING TO BEGIN ASSEMBLING THIS MACHINE**

1. Select an area for assembly that is clean and free of any debris which might cause persons working on the assembly to trip.
2. Do not lift heavy parts or assemblies. Use crane, jack, tackle, fork trucks or other mechanical devices.
3. Preview the assembly instructions in your operator's manual before proceeding further.
4. If the assembly instructions call for parts or assemblies to be blocked up, use only blocking material that is in good condition and is capable of handling the weight of the assembly to be blocked. Also insure that the blocking material is on a clean, dry surface.
5. Never put hands, or any part of body, under blocked up assemblies if at all possible.
6. After completing assembly, thoroughly inspect the machine to be sure that all nuts, bolts, hydraulic fittings or any other fastened assemblies have been thoroughly tightened.
7. Before operating the machine, thoroughly read the operation section of your operator's manual.
8. Before operating, read the maintenance section of your operator's manual to be sure that any parts requiring lubrication, such as gearboxes, are full, to avoid any possible damage.
9. **Before operating equipment – If you have any questions regarding the proper assembly or operation, contact your dealer or representative.**

# TABLE OF CONTENTS

WARRANTY .....	2
SAFETY INFORMATION .....	3 - 10
SAFETY SIGNS .....	11
PREPARATION INSTRUCTIONS .....	12 - 13
OPERATING INSTRUCTIONS .....	14 - 16
OWNER SERVICE .....	17
PARTS LISTS .....	18 - 22

SI NO LEEINGLES, PIDA AYUDA A AIGUIEN QUE SI LO LEA PARA QUE LE TRADUZCA LAS MEDIDAS DE SEGURIDAD.

## STATEMENT OF POLICY

It is the policy of Worksaver, Inc. to improve its products where it is possible and practical to do so. Worksaver, Inc. reserves the right to make changes or improvements in design and construction at any time, without incurring the obligation to make these changes on previously manufactured units.

## TO THE OWNER:

Read this manual before using your Bale Spear Attachment. This manual is provided to give you the necessary operating and maintenance instructions for keeping your Bale Spear Attachment in top operating condition. Please read this manual thoroughly. Understand what each control is for and how to use it. Observe all safety signs on the machine and noted throughout the manual for safe operation of implement. Keep this manual handy for ready reference.

Like all mechanical products, it will require cleaning and upkeep.

Use only genuine Worksaver, Inc. service parts. Substitute parts will void the warranty and may not meet standards required for safe and satisfactory operation. Record the model and serial number of your Attachment here:

Model: \_\_\_\_\_ Serial Number: \_\_\_\_\_

---

---

## RETAIL CUSTOMER'S RESPONSIBILITY

**It is the Retail Customer and/or Operator's responsibility to read the Operator's Manual, to operate, lubricate, maintain, and store the product in accordance with all instructions and safety procedures. Failure of the operator to read the Operator's Manual is a misuse of this equipment.**

**It is the Retail Customer and/or Operator's responsibility to inspect the product and to have any part(s) repaired or replaced when continued operation would cause damage or excessive wear to other parts or cause a safety hazard.**

**It is the Retail Customer's responsibility to deliver the product to the authorized Worksaver Dealer, from whom he purchased it, for service or replacement of defective parts which are covered by warranty. Repairs to be submitted for warranty consideration must be made within forty-five (45) days of failure.**

**It is the Retail Customer's responsibility for any cost incurred by the Dealer for traveling to or hauling of the product for the purpose of performing a warranty obligation or inspection.**

# LIMITED WARRANTY



Worksaver warrants to the original purchaser of any new Bale Spear Attachment, that the equipment be free from defects in material and workmanship for a period of six (6) months for non-commercial, state, and municipalities. Use sixty (60) days for commercial use from date of retail sale.

Replacement or repair parts installed in the equipment covered by this warranty are warranted for ninety (90) days from the date of purchase of such part or to the expiration of the applicable new equipment warranty period, whichever occurs later.

Such parts shall be provided at no cost to the user during regular working hours. Worksaver reserves the right to inspect any equipment or parts which are claimed to have been defective in material or workmanship.

## DISCLAIMER OF IMPLIED WARRANTIES & CONSEQUENTIAL DAMAGES

Worksaver's obligation under this warranty, to the extent allowed by law, is in lieu of all warranties, implied or expressed, including implied warranties of merchantability and fitness for a particular purpose and any liability for incidental and consequential damages with respect to the sale or use of the items warranted. Such incidental and consequential damages shall include but not be limited to: transportation charges other than normal freight charges; cost of installation other than cost approved by Worksaver; duty; taxes; charges for normal service or adjustments; loss of crops or any other loss of income; rental of substitute equipment, expenses due to loss, damage, detention or delay in the delivery of equipment or parts resulting from acts beyond the control of Worksaver.

## THIS WARRANTY SHALL NOT APPLY:

1. To vendor items which carry their own warranties, such as hydraulic cylinders, tires, and tubes.
2. If the unit has been subjected to misapplication, abuse, misuse, negligence, fire or other accident.
3. If parts not made or supplied by Worksaver have been used in connection with the unit, if, in sole judgement of Worksaver such use affects its performance, stability, or reliability.
4. If the unit has been altered or repaired outside of an authorized Worksaver dealership in a manner which, in the sole judgement of Worksaver affects its performance, stability or reliability.
5. To normal maintenance service and normal replacement items such as gearbox lubricant, hydraulic fluid, worn blades, or to normal deterioration of such things as belts and exterior finish, due to use or exposure.
6. To expendable or wear items such as teeth, chains, sprockets, belts, springs and other items that in the company's sole judgement is a wear item.

NO EMPLOYEE OR REPRESENTATIVE OF WORKSAVER IS AUTHORIZED TO CHANGE THIS WARRANTY IN ANY WAY OR GRANT ANY OTHER WARRANTY UNLESS SUCH CHANGE IS MADE IN WRITING AND SIGNED BY WORKSAVER'S SERVICE MANAGER, POST OFFICE BOX 100, LITCHFIELD, ILLINOIS 62056-0100.



# To the Owner/Operator/Dealer

All implements with moving parts are potentially hazardous. There is no substitute for a cautious, safe-minded operator who recognizes the potential hazards and follows reasonable safety practices. The manufacturer has designed this implement to be used with all its safety equipment properly attached to minimize the chance of accidents.

## BEFORE YOU START!!

Read the safety messages on the implement and shown in your manual.  
Observe the rules of safety and common sense!



THIS SYMBOL MEANS

- ATTENTION!
- BECOME ALERT!
- YOUR SAFETY IS INVOLVED!

THIS SAFETY ALERT SYMBOL IDENTIFIES IMPORTANT SAFETY WARNING MESSAGES. CAREFULLY READ EACH WARNING MESSAGE THAT FOLLOWS. FAILURE TO UNDERSTAND AND OBEY A SAFETY WARNING, OR RECOGNIZE A SAFETY HAZARD, COULD RESULT IN AN INJURY OR DEATH TO YOU OR OTHERS AROUND YOU. THE OPERATOR IS ULTIMATELY RESPONSIBLE FOR THE SAFETY OF HIMSELF, AS WELL AS OTHERS, IN THE OPERATING AREA OF THE TRACTOR AND ATTACHED EQUIPMENT.

---

## UNDERSTAND SIGNAL WORDS

 **DANGER** Indicates an imminently hazardous situation that, if not avoided, WILL result in DEATH OR VERY SERIOUS INJURY.

 **WARNING** Indicates a imminently hazardous situation that, if not avoided, COULD result in DEATH OR SERIOUS INJURY.

 **CAUTION** Indicates a imminently hazardous situation that, if not avoided, MAY result in MINOR INJURY.

**IMPORTANT** Identifies special instructions or procedures that, if not strictly observed, could result in damage to, or destruction of the machine, attachments or the environment.

**NOTE:** *Identifies points of particular interest for more efficient and convenient operation or repair.*

If you have questions not answered in this manual or require additional copies or the manual is damaged, please contact your dealer or the manufacturer directly.

---

## IMPORTANT SAFETY INFORMATION!

Working with equipment can lead to injuries. Read this manual, and the manual for your tractor, before assembly or operating, to acquaint yourself with the machines. It is the implement owner's responsibility, if this machine is used by any person other than yourself, is loaned or rented, to make certain that the operator, prior to operating:

1. Reads and understands the operator's manuals.
2. Is instructed in safe and proper use.

 The use of this equipment is subject to certain hazards which cannot be protected against by mechanical means or product design. All operators of this equipment must read and understand this entire manual, paying particular attention to safety and operating instructions, prior to using. If there is something in this manual you do not understand, ask your supervisor, or your dealer, to explain it to you.

# SAFETY INSTRUCTIONS (continued)



## EQUIPMENT SAFETY GUIDELINES

Safety of the operator is one of the main concerns in designing and developing a new piece of equipment. Designers and manufacturers build in as many safety features as possible. However, every year many accidents occur which could have been avoided by a few seconds of thought and a more careful approach to handling equipment. You, the operator, can avoid many accidents by observing the following precautions in this section. To avoid personal injury, study the following precautions and insist those working with you, or for you, follow them.

In order to provide a better view, certain photographs or illustrations in this manual may show an assembly with a safety shield removed. However, equipment should never be operated in this condition. Keep all shields in place. If shield removal becomes necessary for repairs, replace the shield prior to use.



Replace any CAUTION, WARNING, DANGER or instruction safety sign that is not readable or is missing. Do not paint over, remove or deface any safety signs or warning signs on your equipment. Observe all safety signs and practice the instruction on them. Review the safety instructions with all users annually.



This equipment is dangerous to children and persons unfamiliar with its operation. The operator should be a responsible adult familiar with farm machinery and trained in this equipment's operations. **Do not allow persons to operate or assemble this unit until they have read this manual and have developed a thorough understanding of the safety precautions and of how it works.**



To prevent injury or death, use a tractor equipped with a Roll-Over Protective System (ROPS). Keep foldable ROPS systems in "locked up" position at all times.



Never use alcoholic beverages or drugs which can hinder alertness or coordination while operating this equipment. Consult your doctor about operating this machine while taking prescription or over the counter medications.



Personal protection equipment including hard hat, safety glasses, safety shoes, and gloves are recommended during assembly, installation, operation, adjustment, maintaining, repairing, removal, or moving the implement. Do not allow long hair, loose fitting clothing or jewelry to be around moving parts.



Never exceed the limits of a piece of machinery. If its ability to do a job, or to do so safely, is in question – **DON'T TRY IT.**



Do not modify the equipment in any way. Unauthorized modification may impair the function and/or safety and could affect the life of the equipment.















In addition to the design and configuration of this implement, including Safety Signs and Safety Equipment, hazard control and accident prevention are dependent upon the awareness, concern, prudence, and proper training of personnel involved in the operation, transport, maintenance, and storage of the machine. Refer also to Safety Messages and Operation Instructions in each of the appropriate sections of the Tractor and Implement Manuals. Pay close attention to the Safety Signs affixed to the Tractor and the Implement.

# **SAFETY INSTRUCTIONS (continued)**



## **OPERATIONAL SAFETY**

-  Start tractor only when properly seated in the tractor seat. Starting a tractor in gear can result in injury or death. Do not mount or dismount the tractor while the tractor is moving. Mount or dismount the tractor only when the tractor and all moving parts are completely stopped.
-  Operate the tractor and/or implement controls only while properly seated in the tractor seat with the seat belt securely fastened around you. Inadvertent movement of the tractor or implement may cause serious injury or death.
-  Keep all helpers and bystanders twenty-five feet (25') from an operating power unit and attached equipment. Only properly trained people should operate this machine. It is recommended the tractor be equipped with a Rollover Protection System (ROPS) and a seat belt that is used. Always stop the tractor, skid steer, or forklift, set brake, shut off the engine, remove the ignition key, and lower loader and attachment to the ground before dismounting. Never leave equipment unattended with the engine running.
-  Please remember it is important that you read and heed the safety signs on the front loader attachment and loader, and the safety rules set forth. Clean or replace all safety signs if they cannot be clearly read and understood. They are there for your safety as well as the safety of others. The safe use of this machine is strictly up to you, the operator.
-  Be sure power unit is in good condition. Read all the safety precautions and make sure all operators are familiar with the safety rules of operation.
-  Never leave the tractor and implement unattended while the implement is in the lifted position. Accidental operation of lifting lever or a hydraulic failure may cause sudden drop of unit with injury or death by crushing.
-  When the use of hand tools is required to perform any part of assembly, installation, adjustment, maintaining, repairing, removal, or moving the implement, be sure the tools used are designed and recommended by the tool manufacturer for that specific task.
-  Never allow children to play on or around tractor or implement. Children can slip or fall off the equipment and be injured or killed. Inadvertent contact with controls can cause the implement to shift or fall crushing themselves or others.
-  Always use two people to handle heavy, unwieldy components during assembly, installation, removal, or moving the loader attachment.
-  Never place any part of your body where it would be in danger if movement should occur during assembly, installation, operation, maintaining, repairing, removal, or moving the implement.
-  The use of any loader attachment is NOT recommended on tractor with a tricycle wheel arrangement. Tricycle type tractors are unstable for front loader use.
-  A heavy load can cause instability in driving a power unit. Make sure the front or rear of the power unit is properly counter-balanced with weights. Always drive slowly – especially around turns. An unstable power unit could steer badly and possibly tip over, causing injury or death.

# SAFETY INSTRUCTIONS (continued)



## OPERATIONAL SAFETY (continued)



Do not allow children or others to ride on the power unit with an operator. Riders are subject to injury such as being struck by foreign objects or being thrown off. Riders obstruct the operator's view resulting in unsafe operation. **Never allow anyone to ride on the implement!**



Before you operate any equipment, check over all pins, bolts and connections to be sure all are securely in place. Replace any damaged or worn parts immediately.



Check that this attachment is securely mounted to the loader. Failure to install lock pins or have the latching mechanism engage could result in injury or death.



Do not work under a raised loader unless it is securely blocked or held in position. Do not depend on the power unit hydraulic system to hold the implement in place.



Operate the loader controls smoothly, avoiding jerky operation. Stop loader gradually when lowering or lifting loads.



Beware of low electrical wires when loader is raised. Serious injury or death can result if contact is made.



When handling bales on a slope, always approach the bale with the power unit facing uphill.



When stacking bales, ALWAYS MAKE SURE BALES ARE PLACED SO THE STACK IS STABLE.



Keep all bystanders at a safe distance. REMEMBER FALLING BALES CAN ROLL OR TUMBLE.



Do not handle loads that exceed the weight limitations of the loader.



Carry the loads slowly and as low as possible to the ground. Avoid excessive speed during operation.



For operator safety, always keep load in front of power unit. NEVER position load back over operator. ALWAYS BE CAREFUL!















Keep alert and watch the rear as well as the front when working with the loader. Beware of lift clearance when raising loader to maximum height.

# SAFETY INSTRUCTIONS (continued)



## OPERATIONAL SAFETY (continued)















-  Be certain the power unit is in neutral or park position before starting engine.
-  Always shut off power unit and shift to “Park” or set brakes when leaving unit. Always lower bucket or attachment to ground, relieve all hydraulic pressure. Remove key when leaving equipment unattended. Park in level area.
-  Operate loader from operator’s seat only. Remain at controls until operating cycle is complete.
-  Use extreme care when working on inclines and hillsides. Do not operate close to ditches, creeks or holes. Slow down when operating over rough ground.
-  When maneuvering close to buildings or passing through narrow areas, be sure to allow sufficient clearance for the power unit, loader, and load. Drive slowly. Allow for additional length of loader and load on power unit while turning.
-  Keep load centered on attachment and loader. Unbalanced loads increase possibility of tipping or roll-over.
-  Never allow anyone to walk or work under a raised loader.
-  Be sure that people, livestock, or pets are not standing near the machine while operating.
-  Do not lift or carry anyone on loader or in bucket or on attachment. Do not use loader for a work platform.
-  ALWAYS lower loader to the ground or block securely before performing any maintenance work.
-  Always keep power unit on solid footing when operating loader.
-  Observe Safety Recommendations in loader instruction manual.
-  Inspect the entire machine periodically as indicated in the Maintenance Section of this manual. Look for loose fasteners, worn or broken parts, pinched hydraulic hoses, and leaky or loose fittings. Make sure all pins have cotter pins and washers. Serious injury may occur from not maintaining this machine in good working order.



# SAFETY INSTRUCTIONS (continued)



## TRANSPORT SAFETY











-  Comply with state and local laws governing highway safety and movement of farm machinery on public roads.
-  The use of flashing amber lights is acceptable in most localities. However, some localities prohibit their use. Local laws should be checked for all highway lighting and marking requirements.
-  When driving the tractor and equipment on the road or highway under 20 mph (32 kph) at night or during the day, use flashing amber warning lights and a slow moving vehicle (SMV) identification emblem.
-  Always be sure the implement is in the proper raised position for transport.
-  Reduce speed when transporting mounted implements to avoid bouncing and momentary loss of steering control.
-  Be aware of the operating conditions. Do not operate the tractor with weak or faulty brakes. When operating down a hill or on wet or rain slick roads, the braking distance increases; use extreme care and reduce your speed in these conditions. When operating in traffic, always use the tractor's flashing warning lights and reduce your speed. Be aware of traffic around you and watch out for the other guy.
-  Do not drink and drive!
-  Watch for traffic when operating near or crossing roadways. Plan your route to avoid heavy traffic.
-  Turn curves or go up or down hills only at a low speed and at a gradual steering angle. Make certain that at least 20% of the tractor's weight is on the front wheels to maintain safe steering. Slow down on rough or uneven surfaces, and loose gravel.
-  Use extreme care and maintain minimum ground speed when transporting on hillside, over rough ground and when operating close to ditches or fences. Be careful when turning sharp corners.
-  Never allow riders on either power unit or implement. Falling off can kill.
-  Be a safe and courteous driver. Always yield to oncoming traffic in all situations, including narrow bridges, intersections, etc.
-  Do not exceed 20 mph (32 kph). Reduce speed on rough roads and surfaces.
-  Always disengage PTO before driving the tractor to transport the implement from one place to another.

# **SAFETY INSTRUCTIONS (continued)**



## **MAINTENANCE SAFETY**

**Good maintenance is your responsibility. Poor maintenance is an invitation to trouble.**

-  Before working on this machine, drive to a level area, disengage the PTO, lower implement or loader (or if working underneath, raise and block securely), shut off the engine, relieve all hydraulic pressure, set the brakes, and remove the ignition keys.
  
-  Never work under equipment unless it is blocked securely. Never depend on hydraulic system to keep implement in raised position.
  
-  Do not use blocking made of concrete blocks, logs, buckets, barrels or any other material that could suddenly collapse or shift positions. Use only good quality blocking material.
  
-  Never operate controls from the ground. Operate the controls only from the operator's station.
  
-  Keep all persons away from operator control area while performing adjustments, service, or maintenance.
  
-  Always use personal protection devices such as eye, hand and hearing protectors, when performing any service or maintenance.
  
-  Periodically tighten all bolts, nuts and screws and check that all cotter pins are properly installed to ensure unit is in a safe condition.
  
-  When completing a maintenance or service function, make sure all safety shields and devices are installed before placing unit in service.
  
-  Never use your hands to locate a hydraulic leak on attachments. Use a small piece of cardboard or wood. Hydraulic fluid escaping under pressure can penetrate the skin.
  
-  Openings in the skin and minor cuts are susceptible to infection from hydraulic fluid. If injured by escaping hydraulic fluid, see a doctor at once. Gangrene and death can result. Without immediate medical treatment, serious infection and reactions can occur.

# SAFETY INSTRUCTIONS (continued)



## STORAGE SAFETY



Following operation, or when unhooking, stop the tractor, set the brakes, disengage the PTO, shut off the engine and remove the ignition keys.



Use extreme care to keep feet and hands from under the unit and clear of any pinch points. Never stand or allow another person to stand between a running tractor and the unit when disconnecting the implement from the tractor 3-point hitch.



Do not park equipment where it will be exposed to livestock for long periods of time. Damage and livestock injury could result.



Store the unit in an area away from human activity. Do not permit children to play on or around the stored unit.



Make sure all parked machines are on a hard, level surface and engage all safety devices. Storage location should be level and solid to make connecting and unconnecting to power unit easy.



## SAFETY SIGNS

Keep safety signs clean and legible at all times.

Replace safety signs that are missing or have become illegible.

Replaced parts that displayed a safety sign should also display the current sign.

Safety signs are available from your Distributor or Dealer Parts Department or the factory.

### **How to Install Safety Signs:**

Be sure that the installation area is clean and dry. Be sure temperature is above 50°F (10°C).

Decide on the exact position before you remove the backing paper.

Remove the smallest portion of the split backing paper. Align the sign over the specified area and carefully press the small portion with the exposed sticky backing in place.

Slowly peel back the remaining paper and carefully smooth the remaining portion of the sign in place. Small air pockets can be pierced with a pin and smoothed out using the piece of sign backing paper.

# SAFETY SIGNS

## **WARNING**

Always insert spears in bale – never under bale.

Failure to do this can allow bale roll back when loader is raised, causing serious injury or death.

101127

(For FLBS-3000, FLBS-330, FLBS-340, FLBS-432, FLBS-449)

## **BE CAREFUL!**

Use a clean, damp cloth to clean safety decals. Avoid spraying to close to decals when using a pressure washer; high-pressure water can enter through very small scratches or under edges of decals causing them to peel or come off.

## **REMEMBER:**

If Safety Signs have been damaged, removed, become illegible or parts replaced without Signs, new Safety Signs must be applied. New Safety Signs are available from your authorized distributor or factory.

## **WARNING**

- Read and follow owner's manual before installing, operating, or performing maintenance on this attachment. Observe safety recommendations in manual.
- Do not exceed weight limit of attachment or tractor.
- Do not lift or carry anyone on attachment.
- Attachment should be used with the proper weight package on front of tractor or with a loader installed. When handling loads on both ends of tractor, load rear first and unload last.
- Set wheels wide for increased stability.
- Never raise load to extreme heights on steep inclines.
- When handling large round bale, keep load as low as practical to maximize tractor stability.
- Make sure large round bale transported on tractor rear three point hitch attachment does not obstruct visibility of tractor's flashing lights or SMV sign.
- Do not stand or work under raised attachment.
- Stop engine, lower arms, relieve all hydraulic pressure, and lock brakes before leaving operator's seat.
- Failure to observe the above precautions can result in serious injury or death.

101277

# INSTRUCTIONS

## TRACTOR AND LOADER REQUIREMENTS AND PREPARATION

The Universal Bale Spear attachments are designed to fit most double-cylinder front end loaders with a load-arm center distance of 52 inches or less. Optional brackets are available to fit both pin-on and some popular quick coupler front-end loaders. Brackets must be ordered with the bale spear attachment to mount on your loader.

Check your tractor and front loader to make sure they are in good working condition. Check all frame mounting bolts to make sure they are tight.

Loaders that attach to the tractor frame rails should have a cross-tie installed for stability.

Check the tractor's hydraulic system. Be sure the hydraulic oil and filter have been serviced according to manufacturer's recommendations. Refer to your tractor or loader operator's manual or dealer for any adjustments necessary to put the hydraulic system in good working order.

Be sure tires and rims are in good condition. Inflate tires to the proper recommended air pressure.

The required size of the tractor and front loader will be determined by the size and weight of the bales to be handled.

Remember, high moisture hay (silage) bales are very heavy in relation to similar size dry hay bales.

Always use a power unit/loader large enough to safely handle your bales.

Always be sure your power unit is properly counterbalanced for a safe operation.  **It is a good practice to use a loader with an equal or greater SAE operating load capacity.**

### **WARNING**

On multiple spear models FLBS-3000, FLBS-330, FLBS-340, FLBS-432, and FLBS-449, always insert spears into the bale – NEVER under the bale. Failure to insert spears into bale can allow bale to roll back when loader is raised, causing serious injury or death.

### **CAUTION**

Be sure your tractor and loader is in good condition. Read all the safety precautions and make sure all equipment operators are familiar with the safety rules of operation.

The maximum recommended weight of large round bales that can be handled by the various single/two spear models and weights of rectangular bales that can be handled by three/four spear units are as follows:

<u>Model</u>	<u>Spear Type</u>	<u>Bale Weight</u>
FLBS-2200	Forged	Up to 2200 lb.
FLBS-3000	Forged (2)	Up to 3000 lb.
FLBS-330	Forged (3)	Up to 3000 lb.
FLBS-340	Forged (3)	Up to 4000 lb.
FLBS-432	Forged (4)	Up to 4000 lb.
FLBS-449	Forged (4)	Up to 4000 lb.
FLBS-6000	Forged (4)	Up to 6000 lb.

### **WARNING**

■ Power unit must be equipped with ROPS or ROPS cab and seat belt. Keep seat belt securely fastened. Falling off power unit can result in death from being run over or crushed. Keep foldable ROPS systems in “locked up” position at all times.

■ Do not exceed the maximum recommended bale weight listed for each of the loader spear models. Damage to the equipment or serious personal injury could result.

■ A heavy load can cause instability in driving a tractor. Make sure the rear of the tractor is properly counter-balanced with weights. Always drive slowly – especially around turns. An unstable tractor could steer badly and possibly tip over, causing injury or death.

■ The use of any loader attachment is NOT recommended on tractors with a tricycle wheel arrangement. Tricycle type tractors are unstable for front loader use.

# INSTRUCTIONS (continued)

## PACKING

---

The Universal Bale Spears are usually shipped on a pallet. The pallet should contain: (1) Main Frame Assembly; Main Forged Spear(s) (1 for FLBS-2000), (2 for FLBS-3000), (3 for FLBS-330 / 340), (4 for FLBS-432 / FLBS-449 and FLBS-6000); and an owner's manual.

Mounting brackets will be on the pallet if ordered with the attachment. A hardware box will be with the mounting brackets.

## ASSEMBLY

---

Refer to the "exploded views" on pages 18-22 of this manual.

Carefully follow instructions for final assembly.

Before attempting assembly check the following items. Having all the needed parts and equipment readily at hand will speed up your assembly task and will make the job as safe as possible.

- Check for fasteners and pins that were shipped with the attachment and optional brackets.
- Have a minimum of 2 people at hand during assembly.
- Check to see that all nuts are tightened.

Remove the bucket from your front end loader. Check your loader to make sure it is in good working order. Check all frame mounting bolts to make sure they are tight.

Loaders that attach to the tractor frame rails should have a cross-tie installed for stability.

## ASSEMBLY – PIN ON ATTACHMENT

---

Assemble the two (2) lift brackets on the main frame (Ref. #1) with the  $\frac{5}{8}$ " x 3" I.D. U-Bolts. Leave the U-Bolts loose.

**NOTE:** The 830345 universal lift channel brackets are supplied with 1" diameter pins to fit your loader. If your loader requires  $1\frac{1}{8}$ " pins, it will be necessary for the hole diameter in the channel brackets to be drilled out to  $1\frac{5}{32}$ " (1.156") and ask your dealer to order  $1\frac{1}{8}$ " diameter pins. The  $1\frac{1}{8}$ " pins are part #830318. Be sure to indicate if two or four  $1\frac{1}{8}$ " pins are required.

If your loader requires  $1\frac{1}{4}$ " diameter pins, please ask your dealer to order adapter bushings (part #830319). Be sure to indicate how many adapter bushings are required.

**NOTE:** The Ford (New Holland) models 7109, 7209, 7210, 7309, 7310 and 7410 Pin Type Loaders require special brackets. Also, Rhino (Alamo) models 2410 and 2491. Order #830330 bracket kit.

**NOTE:** For loaders that require brackets that provide additional roll back, order #830335 (1" pins).

Connect the assembly to the loader arms using the bottom hole in the channel and attach the upper control cylinder to the top hole in the lift channels. Center the main frame (side to side) with your loader arms and tighten the four (4)  $\frac{5}{8}$ " x 3" U-Bolts.

The lower hole positions in the lift channels can be used to obtain more angle movement. However, if the frame becomes too parallel with the loader lift arms, the loader may not have enough power (mechanical advantage) to bring the frame back.

**NOTE:** Generally, it is not recommended to have the tilt cylinders located any closer than 10-12 inches to the main loader lift arms. **Check the spacing of mounting pins on your loader bucket and use this as a guide.**

If tilt cylinders are located too close to the loader arms, they may go "over center" when fully extended. If this happens, damage may occur to the cylinders and/or mounting brackets.



## CAUTION

**To help prevent personal injury, stand clear of frame and loader. Keep feet away from underside of main frame.**

## ASSEMBLY – QUICK ATTACH

---

If your tractor loader has a bucket Quick Attach feature, check with your dealer on the availability of adapter brackets for your brand and model loader.

Measure the width of the front adapter on your loader and locate the Quick Attach brackets on the main frame. Locate these brackets so the main frame will be centered on your loader.

Tighten the U-bolts that connect the brackets to the main frame.



## CAUTION

**ALWAYS CHECK LATCH PINS BEFORE TILTING OR OPERATING ANY ATTACHMENT.**

# INSTRUCTIONS (continued)

## ASSEMBLY (continued)

---

Connect the main frame to the loader.

Raise the loader and main frame slightly so that the bottom of the main frame is about one or two inches off the ground. Engage tractor parking brake and shut off the engine.

Place some solid blocking under the main frame of the bale spear attachment for safety.

- A.** On the FLBS-2200, insert the long, forged main spear into the casting socket and align the cross hole in the spear with the hole in the socket. Install the 1/2" x 3" bolt and tighten the nut.

Locate the stabilizer spear into the lower socket. Secure with the 5/16" bolt provided.

- B.** Models FLBS-3000, FLBS-330, FLBS-340, FLBS-432, and FLBS-449 install the long, forged main spears into the casting sockets in the main frame and align the cross hole in the spear with the hole in the socket. Install the 1/2" x 3" bolt and tighten the nut on each spear.

- C.** On the Model FLBS-6000, install the long, forged main spears into the sockets in the main frame and align the cross hole in the spear with the hole in the socket. Install the 1/2" x 3" bolt and tighten the nut on each spear.

## OPERATION

---

The operator is responsible for the safe operation of this equipment. The operator must be properly trained. Operators should be familiar with the attachment, tractor, and loader and all safety practices before starting operation.

Make sure all operators have read the Owner's/Operator's Manual and are familiar with the instructions and the safety rules of operation.

Be sure tractor is properly counter-balanced with weights before attempting to lift any load with the Bale Spear attachment.

If you are handling bales with both the front end loader and the 3 pt. hitch on the tractor, always load the 3 pt. attachment first and unload last.

The bale spear is to be used only for handling hay bales. Do not use for digging rocks, pulling out fence, or as a craning device with a chain over the spear.

## LARGE ROUND BALES:

Using the bucket tilt cylinders, adjust the angle of the spear(s) so they are parallel with the center of the hay bale.

With the tractor, push the spear(s) into the large hay bale. Make sure you have penetrated the hay bale far enough so the bale doesn't want to come off the end of the spear(s). If, when you initially pick the bale up, it tends to droop forward, this would indicate you have not penetrated the bale far enough.

Tilt the ends of the spear(s) upward (about 15-20 degrees) when transporting the hay bales. This will reduce any tendency for the bale to slide off the spear(s) while being transported.

When you have placed the hay bale in the desired location, it is recommended to tilt the spear ends slightly downward (5-7 degrees) so as you pull away from the bale it will slide off the spear(s) more easily. Different location and circumstances will determine the best with-draw angle to use.

**NOTE:** Always make sure bale spear fully penetrates the bale. Partial penetration locates all the weight of the bale on the outer end and can damage spear.

**NOTE:** In cold weather, a bale frozen to the ground may exceed the lifting capacity of spear and loader. Damage to spear or loader may occur. Not covered under warranty.

**NOTE:** Soft center bales will tend to droop after being lifted by a single spear. Placing the spear in a lower position in the bale will allow for more lifting height and lessen the load on the stabilizer spears.



## WARNING

**Do not operate this product until you have positive indication that this attachment is securely mounted to the loader. Failure to install lock pins or have the latching mechanism engaged could result in injury or death.**



## CAUTION

**NEVER LET ANYONE CLIMB ON STACKED ROUND HAY BALES!**

# INSTRUCTIONS (continued)

## OPERATION (continued)

### RECTANGULAR BALES:

Using the bucket tilt cylinders, adjust the angle of the spear(s) so they are parallel with the center of the hay bale. Center the spears with the width of the bale.

With the tractor, push the spear(s) into the large hay bale. Make sure you have penetrated the hay bale far enough so the bale doesn't want to come off the end of the spear(s). If, when you initially pick the bale up, it tends to droop forward, this would indicate you have not penetrated the bale far enough.

Tilt the ends of the spear(s) upward (about 15-20 degrees) when transporting the hay bales. This will reduce any tendency for the bale to slide off the spear(s) while being transported.

When you have placed the hay bale in the desired location, it is recommended to tilt the spear ends slightly downward (5-7 degrees) so as you pull away from the bale it will slide off the spear(s) more easily. Different location and circumstances will determine the best withdraw angle to use.

**NOTE:** Optional bolt-on uprights are available to transport two rectangular bales at a time (see page 23). Order #831095 (one pair of uprights).

**NOTE:** Always make sure bale spear fully penetrates the bale. Partial penetration locates all the weight of the bale on the outer end and can damage spear.

**NOTE:** In cold weather, a bale frozen to the ground may exceed the lifting capacity of spear and loader. Damage to spear or loader may occur. Not covered under warranty.



## WARNING

**NEVER** try to handle two rectangular bales at once without the 831095 optional bolt-on uprights installed. Failure to use the uprights can allow the top bale to roll back when loader is raised, causing serious injury or death.

Safety is a primary concern in the design and manufacture of our products. Unfortunately, our efforts to provide safe equipment can be wiped out by an operator's single careless act.

In addition to the design and configuration of equipment, hazard control and accident prevention are dependent upon the awareness, concern, judgement, and proper training of personnel involved in the operation, transport, maintenance and storage of equipment.

It has been said, "The best safety device is an informed, careful operator." We ask you to be that kind of an operator.

### HANDLING ALL BALES:



## DANGER

**Beware of low electrical wires when loader is raised. Serious injury or death can result if contact is made.**

**Do not leave the operator's seat if any part of the tractor or implement contacts electric lines.**

When stacking bales, ALWAYS MAKE SURE BALES ARE PLACED SO THE STACK IS STABLE.

Keep all bystanders at a safe distance. REMEMBER – FALLING BALES CAN ROLL OR TUMBLE.



## CAUTION

**Beware of lift clearance when raising loader to maximum height.**



## WARNING

■ Never exceed the lift capacity of the tractor-loader used with the spear attachment.

■ A heavy load can cause instability in driving a tractor. Make sure the rear of the tractor is properly counter-balanced with weights or a bale. Always drive slowly – especially around turns. An unstable tractor could steer badly and possibly tip over, causing injury or death.



# INSTRUCTIONS (continued)

## **HANDLE BALES SAFELY**

Improper use of loaders to handle bales can result in serious injury or death to the operator. This could be caused by the bale tumbling back down the loader into the operator's station.

For optimum stability and visibility:

- Become familiar with controls.
- Be sure anyone operating the loader is aware of safe operation and potential hazards. Read and observe safety recommendations in loader manual.
- Operate loader from operator's seat only. Remain at controls until operating cycle is complete.
- Carry the bale slowly and as low as possible to the ground.
- Operate the loader hydraulic controls smoothly, avoiding jerky operation.
- When handling round bales on a slope, always approach the bale with the power unit facing uphill.
- Never use the tractor/loader to stop a rolling bale.
- Stop loader gradually when lowering or lifting loads.
- Use particular care when working on inclines and hillsides.
- Avoid holes, ditches, and obstructions which may cause tractor/loader to tip.
- Allow for additional length of loader on tractor while turning.
- Never allow anyone to walk or work under a raised loader.
- Be sure that people, livestock, or pets are not standing near the machine while operating.
- Travel slowly over rough ground or when making turns.
- Drive slowly through gates and doors.
- Lower bucket or attachment to ground when loader is unattended.

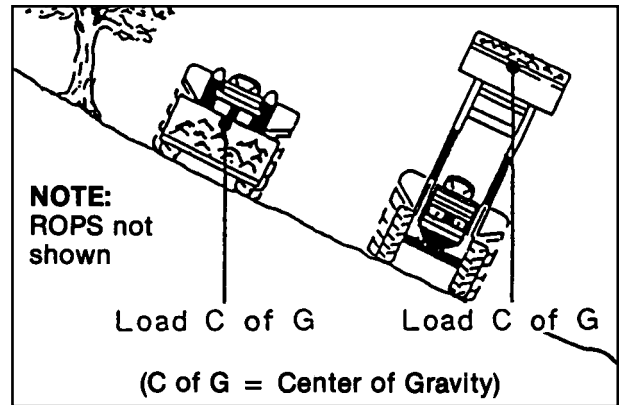

When working on side hills, **DO NOT RAISE LOADER TOO HIGH.** Keep an eye on terrain changes. Keep load low.

## **WARNING**

For multiple spear models, always insert spears into the bale – **NEVER** under the bale. Failure to insert spears into bale can allow bale to roll back when loader is raised, causing serious injury or death.

## **TRANSPORTING**

### **CAUTION**

When traveling on public roads, whether at night or during the day, use accessory light and devices for adequate warnings to operators of other vehicles. Comply with all federal, state and local laws.

Carry load low.

Check visibility. If visibility is impaired, reduce speed or consider other means of bale transport.

Allow for additional length of loader and spear attachment on tractor while turning.

Select a safe ground travel speed when transporting from one area to another. When traveling on roadways, transport in such a way that faster moving vehicles may pass you safely.

When traveling over rough or hilly terrain or when making turns, slow down and use extra care.

Read all the safety warnings in the front of this manual and in the manual of tractor.

# OWNER SERVICE

---

## MAINTENANCE

---



### WARNING

■ **NEVER GO UNDERNEATH EQUIPMENT.** Never place any part of the body underneath equipment or between moveable parts even when the engine has been turned off. Hydraulic system leak down, hydraulic system failures, mechanical failures, or movement of control levers can cause equipment to drop or rotate unexpectedly and cause severe injury or death.

■ **Always stop the tractor, set brake, shut off engine, remove key, and lower loader to ground before attempting to service.** Never leave equipment unattended with engine running.

■ **Keep all persons away from operator control area while performing adjustments, service, or maintenance.**

■ **Do not work under a raised loader unless it is securely blocked or held in position. Do not depend on the hydraulic system to hold loader and attachment in place.**

Check the pins at the ends of the loader arms. Make sure they are locked in place.

Periodically check all bolts to make sure they are tight.

Check the bolt on the forged spears to make sure it is tight.

Lubricate loader as per instructions in loader manual.

Replace safety signs and instruction decals if damaged or missing.

Replace any worn or damaged parts immediately. Do not use attachment with any damaged parts.

## STORAGE

---

- At the end of the working season or when the attachment will not be used for a long period, it is good practice to clean off any dirt or grease that may have accumulated.
- Inspect the attachment for loose, damaged or worn parts and adjust or replace if needed.
- Sand areas where paint is chipped or worn and repaint to prevent rust.
- Storage location should be level and solid to make hitching and unhitching easy.
- Always store in a clean, dry location away from children and livestock.

**Keep children away from danger all day, every day.**

**Please work, drive, play and live each day with care and concern for your safety and that of your family and fellow citizens.**

# FLBS-2200 PARTS LIST

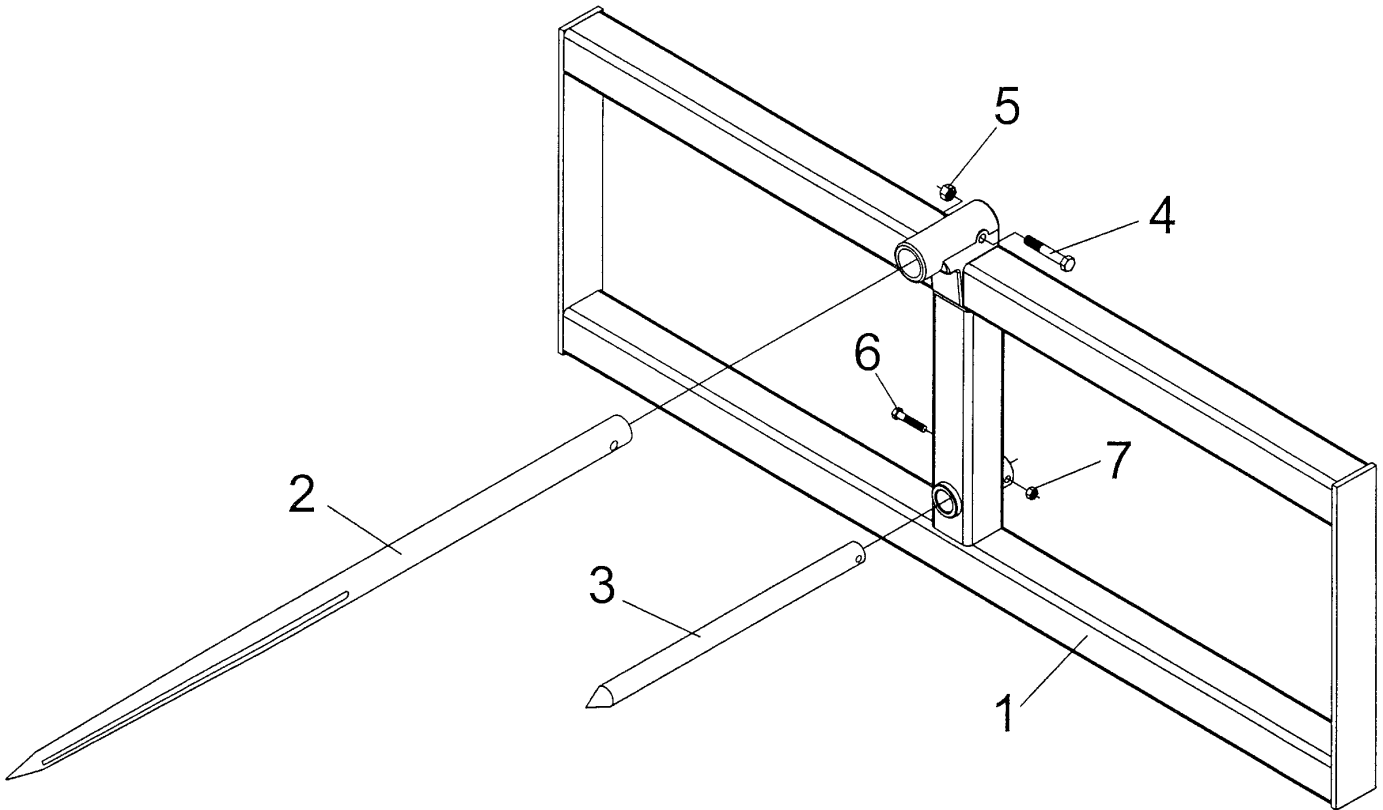

Ref. No.	Part No.	Description	No. Req'd.
1	832381	Main Frame Weldment (FLBS-2200)	1
2	830928	Spear, Bolt-In (47.25")	1
3	830938	Spear 1 1/4" Dia. x 21"	1
4	2503012	Bolt 1/2"-13NC x 3" Hex Head Gr.2	1
5	2500054	Nut 1/2"-13NC Hex Stamplock	1
6	2503205	Bolt 3/8"-16NC x 2 1/2" Hex Head Gr. 5	1
7	2500055	Nut 3/8"-16NC Hex Stamplock	1

# FLBS-3000 PARTS LIST

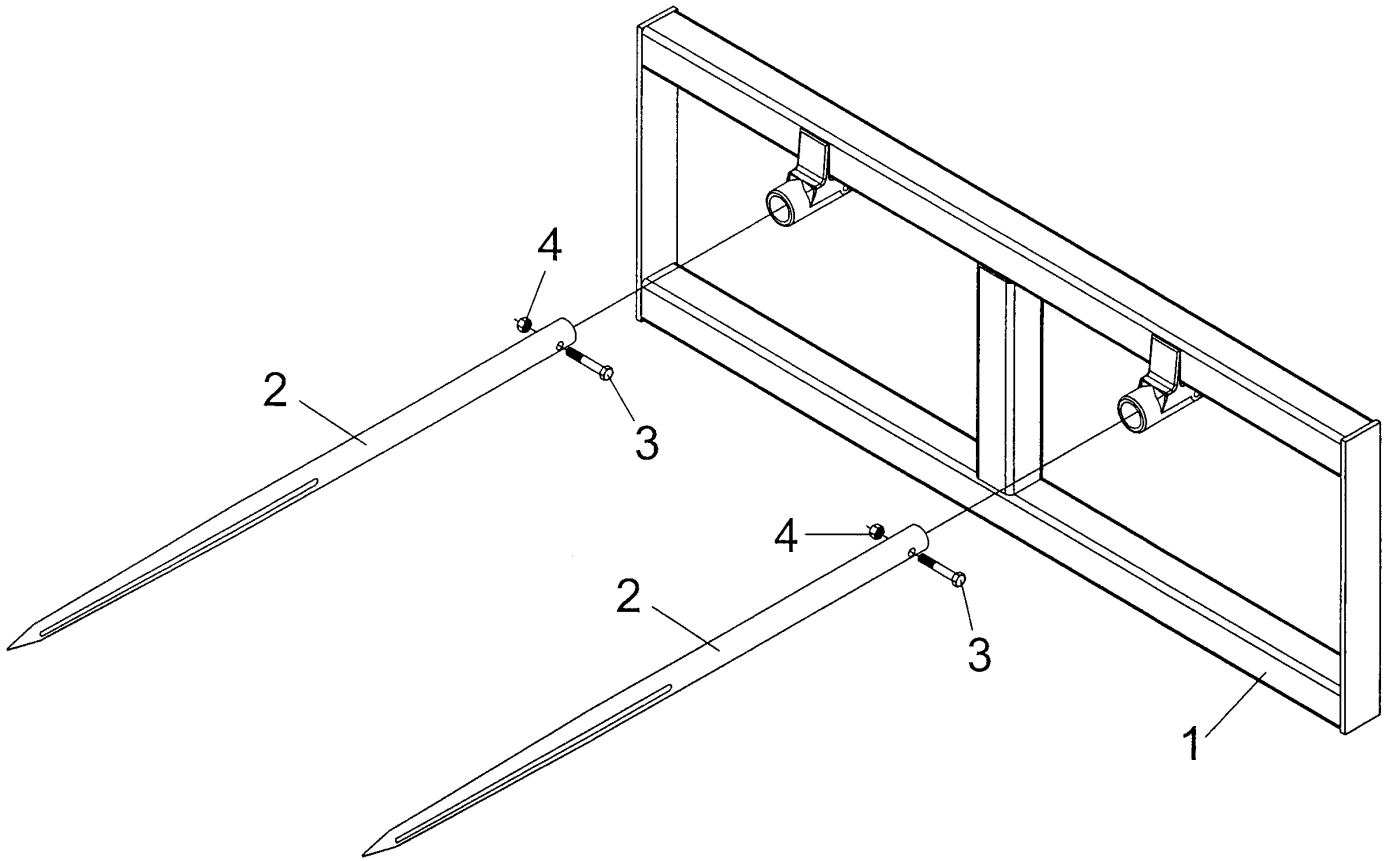

Ref. No.	Part No.	Description	No. Req'd.
1	832386	Main Frame Weldment (FLBS-3000)	1
2	830928	Spear, Bolt-In (47.25")	2
3	2503012	Bolt 1/2"-13NC x 3" Hex Head Gr.2	2
4	2500054	Nut 1/2"-13NC Hex Stamplock	2

## FLBS-330 / FLBS-340 PARTS LIST

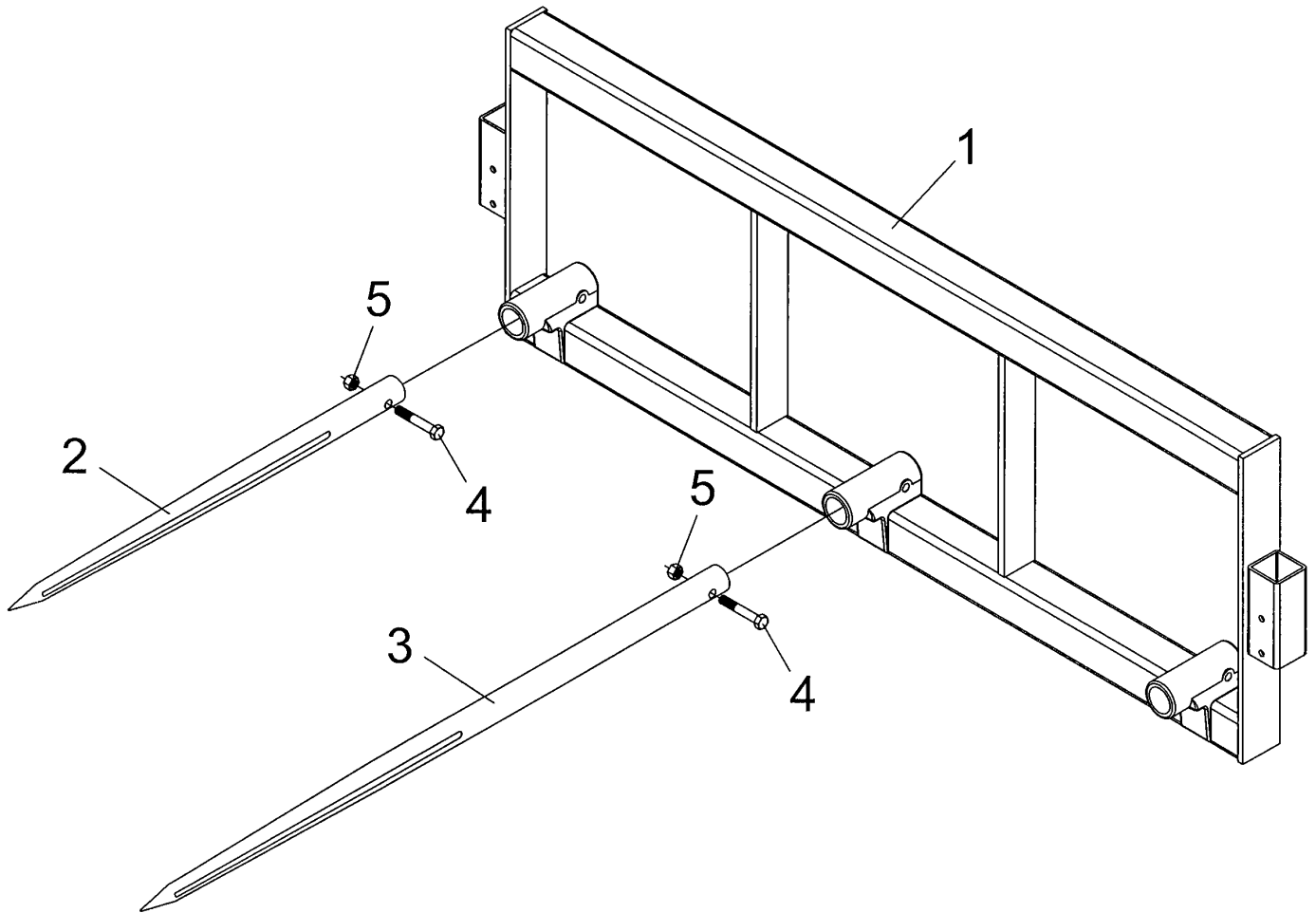

Ref. No.	Part No.	Description	No. Req'd.
1	832391	Main Frame Weldment (FLBS-330/340)	1
2	830924	Spear, Bolt-In (31.50") FLBS-330 only	3
3	830928	Spear, Bolt-In (47.25") FLBS-340 only	3
4	2503012	Bolt 1/2"-13NC x 3" Hex Head Gr.2	3
5	2500054	Nut 1/2"-13NC Hex Stamplock	3

# FLBS-432 / FLBS-449 PARTS LIST

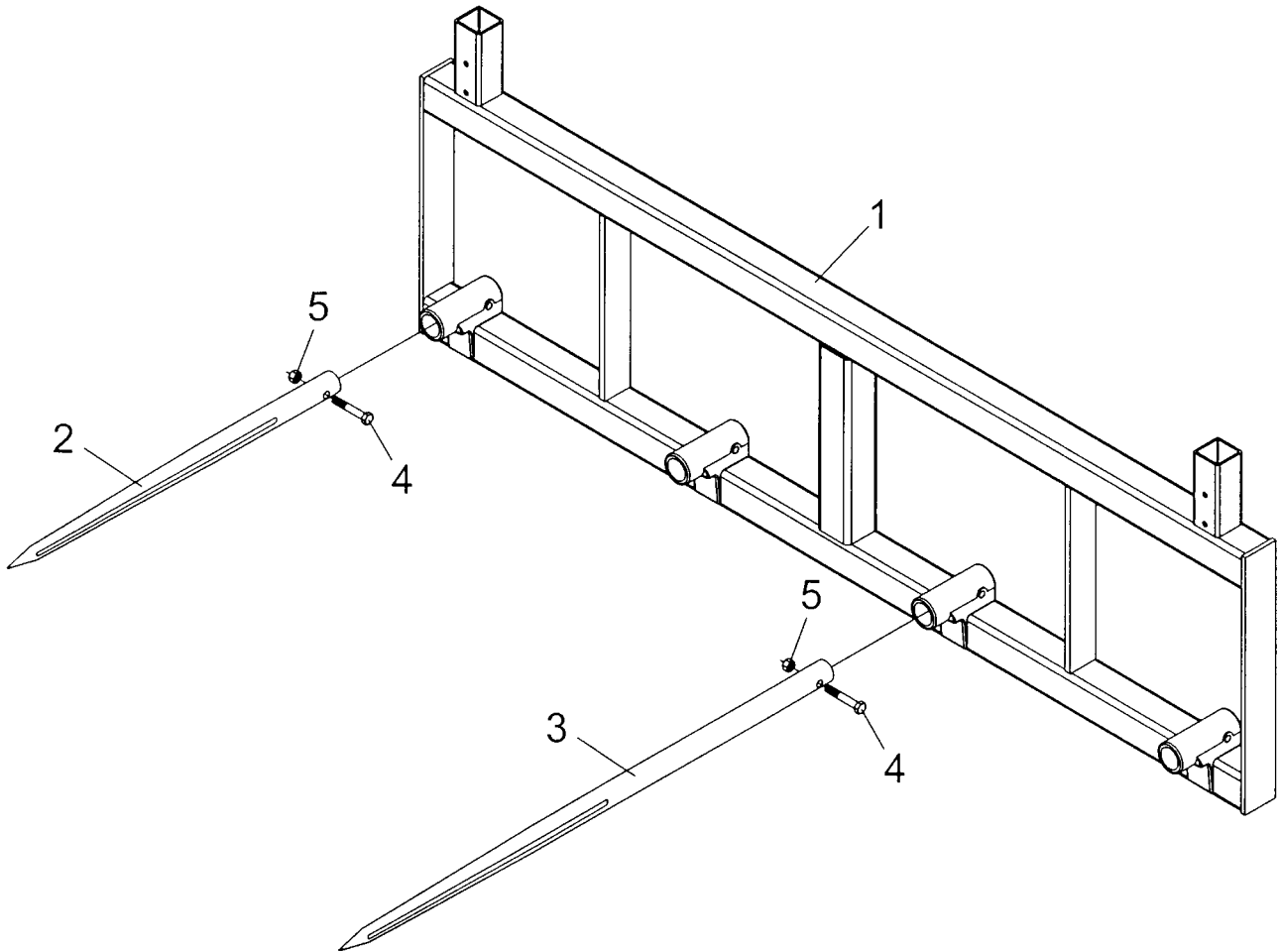

Ref. No.	Part No.	Description	No. Req'd.
1	832406	Main Frame Weldment (FLBS-432/449)	1
2	830924	Spear, Bolt-In (31.50") FLBS-432 only	4
3	830928	Spear, Bolt-In (47.25") FLBS-449 only	4
4	2503012	Bolt 1/2"-13NC x 3" Hex Head Gr.2	4
5	2500054	Nut 1/2"-13NC Hex Stamplock	4

# FLBS-6000 PARTS LIST

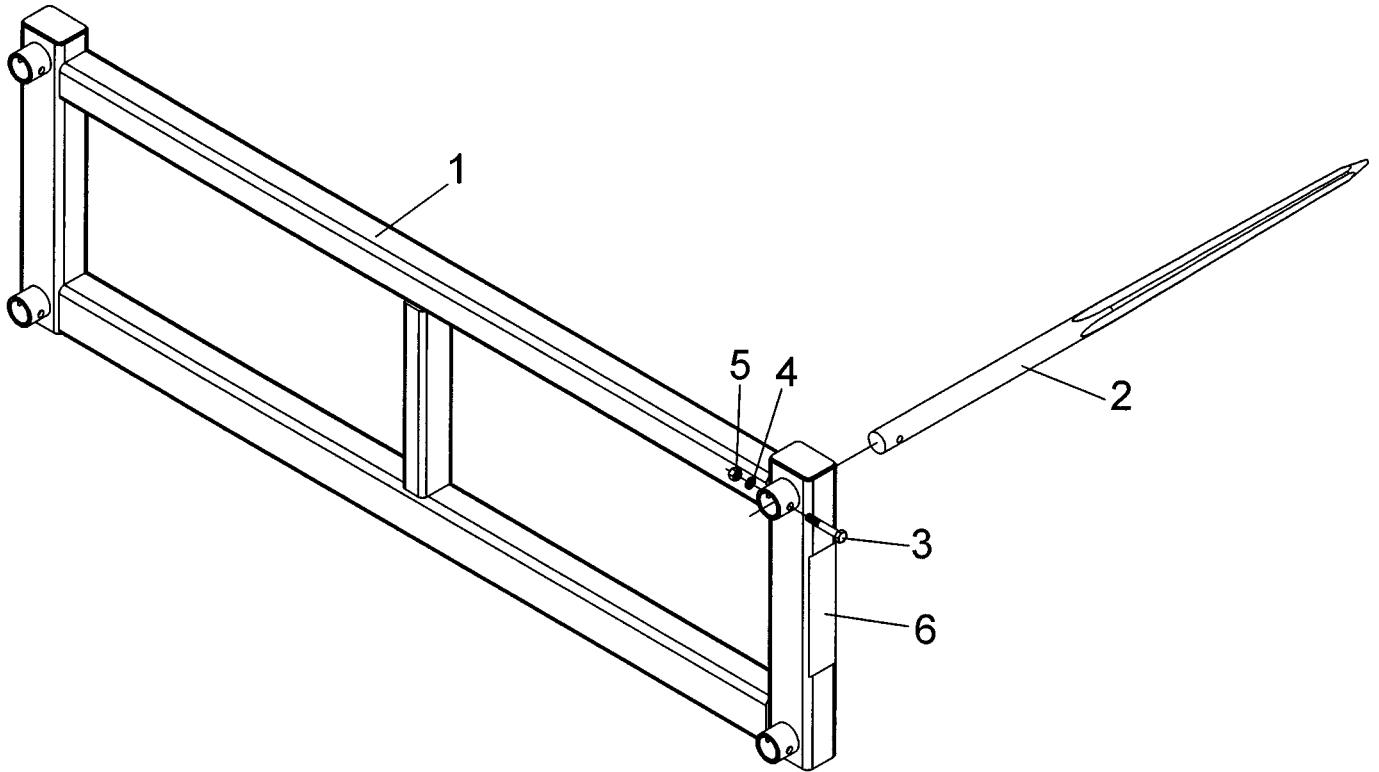

Ref. No.	Part No.	Description	No. Req'd.
1	834166	Main Frame Weldment (FLBS-6000)	1
2	830928	Spear, Bolt-In	4
3	2503012	Bolt 1/2"-13NC x 3" Hex Head Gr. 2	4
4	2502002	Washer 1/2" Spring Lock	4
5	2500003	Nut 1/2"-13NC Full Hex	4
6	101277	Safety Sign - Warning	1

# OPTIONAL BOLT-ON UPRIGHT KIT PARTS LIST

(For Models FLBS-330/340 and FLBS-432/449)

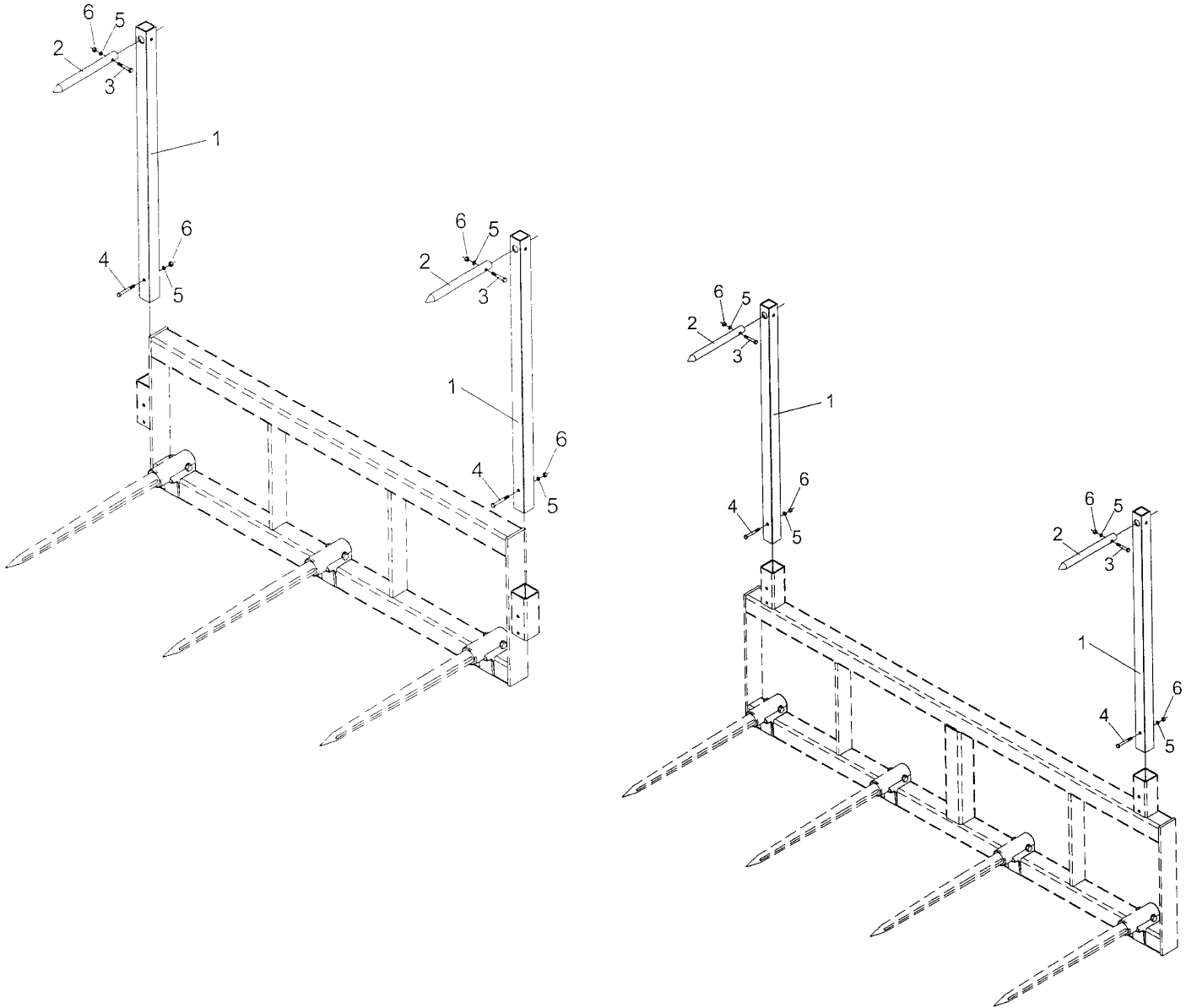

Ref. No.	Part No.	Description	No. Req'd.
1	832285	Tube, Vertical Backstop	2
2	830213	Balance Spike	2
3	2503039	Bolt 3/8"-16NC x 2 1/2" Hex Head Gr.2	2
4	2503209	Bolt 3/8"-16NC x 3" Hex Head Gr.2	2
5	2502008	Washer 3/8" Springlock	4
6	2500004	Nut 3/8"-16NC Full Hex	4





# SAFETY REQUIREMENTS

AVOID ACCIDENTS BY FOLLOWING ALL OF THE SAFETY REQUIREMENTS LISTED BELOW.

- Machinery should be operated only by those who are responsible and are authorized to do so.
- Stop the engine, lower all equipment, lock the brakes, and remove the ignition key before dismounting from the tractor.
- Never stand between tractor and implement while tractor is being backed to hitch.
- Loose fitting clothing should not be worn, to avoid catching on various parts.
- Detach implement in area where children normally do not play.
- When performing adjustments or maintenance on an implement, first lower it to the ground or block it securely at a workable height.
- Only a qualified operator should be permitted on tractor when in operation; no riders allowed.
- Make certain everyone is in the clear before starting tractor or raising or lowering equipment.
- Operate the tractor and implement only while seated in the driver's seat.
- Reduce speed when transporting mounted implements to avoid bouncing and momentary loss of steering control.
- A heavy load can cause instability of the tractor. Use extreme care during road travel. Slow down on turns and watch out for bumps. Tractor may need front counterweights to counter-balance the weight of the implement.
- Reduce speed on hillsides or curves so there is no danger of tipping.
- Avoid driving too close to the edge of ditches or creeks.
- Do not transport implement on public roads without reflectors and slow moving vehicle emblem in daylight and with approved warning lights at night and other periods of poor visibility.
- Due to the width of some implements, use extra caution on highways, farm roads, and when approaching gates.
- Always be sure the implement is in the proper position for transport.
- Keep alert and watch the front as well as the rear when working with the implement.

## OWNER'S/ OPERATOR'S MANUAL

### MODEL NO.'s

**FLBS-2200**

**FLBS-3000**

**FLBS-330**

**FLBS-340**

**FLBS-432**

**FLBS-449**

**FLBS-6000**

SI NO LEEINGLES, PIDA AYUDA  
A AIGUIEN QUE SI LO LEA  
PARA QUE LE TRADUZCA LAS  
MEDIDAS DE SEGURIDAD.

JANUARY 2016

## FRONT LOADER BALE SPEAR ATTACHMENTS

WHEN ORDERING REPAIR PARTS,  
ALWAYS GIVE THE FOLLOWING INFORMATION:

1. PART NUMBER
2. PART DESCRIPTION
3. MODEL NUMBER
4. NAME OF ITEM

**MAKE EVERY DAY  
A HOLIDAY  
FROM ACCIDENTS!**

**WORKSAVER, INC.**

P.O. BOX 100 LITCHFIELD, IL 62056-0100 (217) 324-5973  
WEB: <http://www.worksaver.com> E-MAIL: [sales@worksaver.com](mailto:sales@worksaver.com)