

OWNER'S/ OPERATOR'S MANUAL

MODEL NO.'s

FOD-16

FOC-48

FOC-48A

CAUTION

For Safe Operation
Read Rules And
Instructions Carefully

SI NO LEEINGLES, PIDA AYUDA
A AIGUIEN QUE SI LO LEA
PARA QUE LE TRADUZCA LAS
MEDIDAS DE SEGURIDAD.

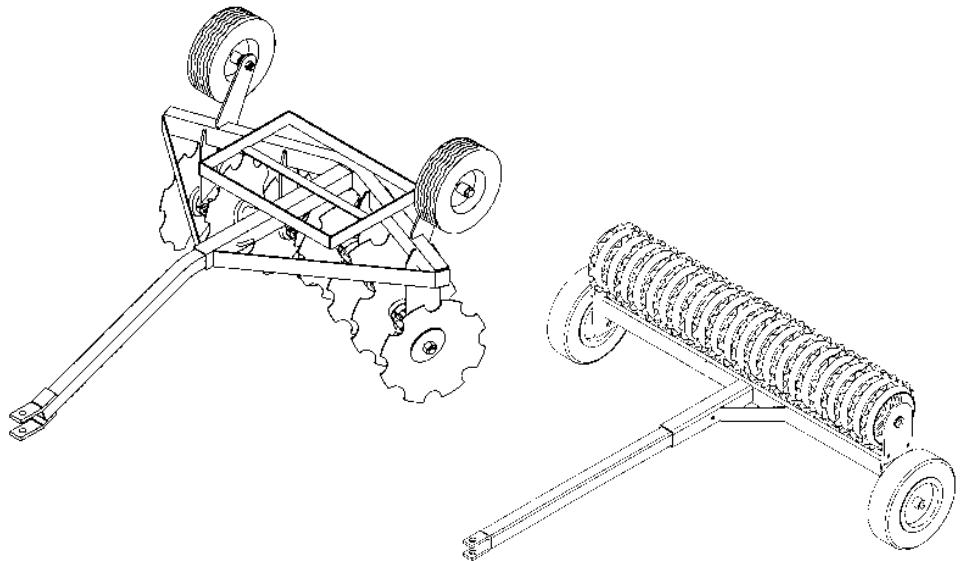

FLIP-OVER SINGLE GANG DISC

FLIP-OVER 4 FT. CULTI-PACKER

Safety Instructions
Tractor Preparation
Operating Instructions

Assembly & Mounting
Maintenance
Repair Parts

CAUTION

**THE FOLLOWING SAFETY PRECAUTIONS SHOULD BE THOROUGHLY UNDERSTOOD
BEFORE ATTEMPTING TO BEGIN ASSEMBLING THIS MACHINE**

1. Select an area for assembly that is clean and free of any debris which might cause persons working on the assembly to trip.
2. Do not lift heavy parts or assemblies. Use crane, jack, tackle, fork trucks or other mechanical devices.
3. Preview the assembly instructions in your operator's manual before proceeding further.
4. If the assembly instructions call for parts or assemblies to be blocked up, use only blocking material that is in good condition and is capable of handling the weight of the assembly to be blocked. Also insure that the blocking material is on a clean, dry surface.
5. Never put hands, or any part of body, under blocked up assemblies if at all possible.
6. After completing assembly, thoroughly inspect the machine to be sure that all nuts, bolts, hydraulic fittings or any other fastened assemblies have been thoroughly tightened.
7. Before operating the machine, thoroughly read the operation section of your operator's manual.
8. Before operating, read the maintenance section of your operator's manual to be sure that any parts requiring lubrication, such as gearboxes, are full, to avoid any possible damage.
9. **Before operating equipment – If you have any questions regarding the proper assembly or operation, contact your dealer or representative.**

TABLE OF CONTENTS

WARRANTY	2
SAFETY INFORMATION	3
SAFETY SIGNS	8
PREPARATION INSTRUCTIONS	9
OPERATING INSTRUCTIONS	11
OWNER SERVICE & LUBRICATION	12
PARTS LISTS	13-15

SI NO LEEINGLES, PIDA AYUDA A
AIGUIEN QUE SI LO LEA PARA QUE
LE TRADUZCA LAS MEDIDAS DE
SEGURIDAD.

STATEMENT OF POLICY

It is the policy of Farm Star to improve its products where it is possible and practical to do so. Farm Star reserves the right to make changes or improvements in design and construction at any time, without incurring the obligation to make these changes on previously manufactured units.

TO THE OWNER:

Read this manual before using your Flip-Over Single Gang Disc or Flip-Over Culti-Packer. This manual is provided to give you the necessary operating and maintenance instructions for keeping your equipment in top operating condition. Please read this manual thoroughly. Understand what each control is for and how to use it. Observe all safety signs on the machine and noted throughout the manual for safe operation of implement. Keep this manual handy for ready reference.

Like all mechanical products, it will require cleaning and upkeep. Lubricate the Disc or Culti-Packer as specified.

Use only genuine Farm Star service parts. Substitute parts will void the warranty and may not meet standards required for safe and satisfactory operation. Record the model and serial number of your Disc or Culti-Packer here:

Model: _____ Serial Number: _____

RETAIL CUSTOMER'S RESPONSIBILITY

It is the Retail Customer and/or Operator's responsibility to read the Operator's Manual, to operate, lubricate, maintain, and store the product in accordance with all instructions and safety procedures. Failure of the operator to read the Operator's Manual is a misuse of this equipment.

It is the Retail Customer and/or Operator's responsibility to inspect the product and to have any part(s) repaired or replaced when continued operation would cause damage or excessive wear to other parts or cause a safety hazard.

It is the Retail Customer's responsibility to deliver the product to the authorized Farm Star Dealer, from whom he purchased it, for service or replacement of defective parts which are covered by warranty. Repairs to be submitted for warranty consideration must be made within forty-five (45) days of failure.

It is the Retail Customer's responsibility for any cost incurred by the Dealer for traveling to or hauling of the product for the purpose of performing a warranty obligation or inspection.

LIMITED WARRANTY



Farm Star warrants to the original purchaser of any new Disc Harrow Model FOD-16 or Model FOC-48, FOC-48A Culti-Packer, that the equipment be free from defects in material and workmanship for a period of six (6) months for non-commercial, state, and municipalities. Use sixty (60) days for commercial use from date of retail sale.

Replacement or repair parts installed in the equipment covered by this warranty are warranted for sixty (60) days from the date of purchase of such part or to the expiration of the applicable new equipment warranty period, whichever occurs later.

Such parts shall be provided at no cost to the user during regular working hours. Farm Star reserves the right to inspect any equipment or parts which are claimed to have been defective in material or workmanship.

DISCLAIMER OF IMPLIED WARRANTIES & CONSEQUENTIAL DAMAGES

Farm Star's obligation under this warranty, to the extent allowed by law, is in lieu of all warranties, implied or expressed, including implied warranties of merchantability and fitness for a particular purpose and any liability for incidental and consequential damages with respect to the sale or use of the items warranted. Such incidental and consequential damages shall include but not be limited to: transportation charges other than normal freight charges; cost of installation other than cost approved by Farm Star; duty; taxes; charges for normal service or adjustments; loss of crops or any other loss of income; rental of substitute equipment, expenses due to loss, damage, detention or delay in the delivery of equipment or parts resulting from acts beyond the control of the manufacturer.

THIS WARRANTY SHALL NOT APPLY:

1. To vendor items which carry their own warranties, such as hydraulic cylinders, tires, and tubes.
2. If the unit has been subjected to misapplication, abuse, misuse, negligence, fire or other accident.
3. If parts not made or supplied by Farm Star have been used in connection with the unit, if, in sole judgement of Farm Star such use affects its performance, stability, or reliability.
4. If the unit has been altered or repaired outside of an authorized dealership in a manner which, in the sole judgement of Farm Star affects its performance, stability or reliability.
5. To normal maintenance service and normal replacement items such as gearbox lubricant, hydraulic fluid, worn blades, or to normal deterioration of such things as belts and exterior finish, due to use or exposure.
6. To expendable or wear items such as disc blades, packer wheels, springs and other items that in the company's sole judgement is a wear item.

NO EMPLOYEE OR REPRESENTATIVE OF FARM STAR IS AUTHORIZED TO CHANGE THIS WARRANTY IN ANY WAY OR GRANT ANY OTHER WARRANTY UNLESS SUCH CHANGE IS MADE IN WRITING AND SIGNED BY FARM STAR'S SERVICE MANAGER, POST OFFICE BOX 100, LITCHFIELD, ILLINOIS 62056-0100.



To the Owner/Operator/Dealer

All implements with moving parts are potentially hazardous. There is no substitute for a cautious, safe-minded operator who recognizes the potential hazards and follows reasonable safety practices. The manufacturer has designed this implement to be used with all its safety equipment properly attached to minimize the chance of accidents.

BEFORE YOU START!!

Read the safety messages on the implement and shown in your manual.
Observe the rules of safety and common sense!



THIS SYMBOL MEANS

- ATTENTION!
- BECOME ALERT!
- YOUR SAFETY IS INVOLVED!

THIS SAFETY ALERT SYMBOL IDENTIFIES IMPORTANT SAFETY WARNING MESSAGES. CAREFULLY READ EACH WARNING MESSAGE THAT FOLLOWS. FAILURE TO UNDERSTAND AND OBEY A SAFETY WARNING, OR RECOGNIZE A SAFETY HAZARD, COULD RESULT IN AN INJURY OR DEATH TO YOU OR OTHERS AROUND YOU. THE OPERATOR IS ULTIMATELY RESPONSIBLE FOR THE SAFETY OF HIMSELF, AS WELL AS OTHERS, IN THE OPERATING AREA OF THE TRACTOR AND ATTACHED EQUIPMENT.

UNDERSTAND SIGNAL WORDS

Note the use of the signal words **DANGER**, **WARNING** and **CAUTION** with the safety messages. The appropriate signal word for each has been selected using the following guidelines:

DANGER: Indicates an imminently hazardous situation that, if not avoided, will result in death or serious injury. This signal word is to be limited to the most extreme situations typically for machine components which, for functional purposes, cannot be guarded.

WARNING: Indicates a potentially hazardous situation that, if not avoided, could result in death or serious injury, and includes hazards that are exposed when guards are removed. It may also be used to alert against unsafe practices.

CAUTION: Indicates a potentially hazardous situation that, if not avoided, may result in minor or moderate injury. It may also be used to alert against unsafe practices.

If you have questions not answered in this manual or require additional copies or the manual is damaged, please contact your dealer or the manufacturer directly.

IMPORTANT SAFETY INFORMATION!

Read this manual, and the manual for your tractor or ATV, before assembly or operating, to acquaint yourself with the machines. It is the implement owner's responsibility, if this machine is used by any person other than yourself, is loaned or rented, to make certain that the operator, prior to operating:

1. Reads and understands the operator's manuals.
2. Is instructed in safe and proper use.



The use of this equipment is subject to certain hazards which cannot be protected against by mechanical means or product design. All operators of this equipment must read and understand this entire manual, paying particular attention to safety and operating instructions, prior to using. If there is something in this manual you do not understand, ask your supervisor, or your dealer, to explain it to you.

SAFETY INSTRUCTIONS (continued)



EQUIPMENT SAFETY GUIDELINES



Safety of the operator is one of the main concerns in designing and developing a new piece of equipment. Designers and manufacturers build in as many safety features as possible. However, every year many accidents occur which could have been avoided by a few seconds of thought and a more careful approach to handling equipment. You, the operator, can avoid many accidents by observing the following precautions in this section. To avoid personal injury, study the following precautions and insist those working with you, or for you, follow them.



Review the safety instructions with all users annually.



This equipment is dangerous to children and persons unfamiliar with its operation. The operator should be a responsible adult familiar with farm machinery and trained in this equipment's operations. **Do not allow persons to operate or assemble this unit until they have read this manual and have developed a thorough understanding of the safety precautions and of how it works.**



To prevent injury or death, use a tractor equipped with a Roll-Over Protective System (ROPS). Do not paint over, remove or deface any safety signs or warning signs on your equipment. Observe all safety signs and practice the instruction on them.



Never exceed the limits of a piece of machinery. If its ability to do a job, or to do so safely, is in question – **DON'T TRY IT.**



Do not modify the equipment in any way. Unauthorized modification may impair the function and/or safety and could affect the life of the equipment.



In addition to the design and configuration of this implement, including Safety Signs and Safety Equipment, hazard control and accident prevention are dependent upon the awareness, concern, prudence, and proper training of personnel involved in the operation, transport, maintenance, and storage of the machine. Refer also to Safety Messages and Operation Instructions in each of the appropriate sections of the Tractor and Implement Manuals. Pay close attention to the Safety Signs affixed to the Tractor and the Implement.



SAFETY SIGNS















Keep safety signs clean and legible at all times.

Replace safety signs that are missing or have become illegible.

Replaced parts that displayed a safety sign should also display the current sign.

Safety signs are available from your Distributor or Dealer Parts Department or the factory.

SAFETY INFORMATION (continued)

-  All equipment is potentially hazardous. There is no substitute for a cautious, safe-minded operator who recognizes potential hazards and follows reasonable safety practices.
-  When the use of hand tools is required to perform any part of assembly, installation, adjustment, maintaining, repairing of the implement, be sure the tools used are designed and recommended by the tool manufacturer for that specific task.
-  Personal protection equipment including safety glasses, helmet, safety shoes, and gloves are recommended during assembly, installation, operation, adjustment, maintaining, repairing of the implement.
-  Always use two people to handle heavy, unwieldy components during assembly or installation of the implement.
-  Never place any part of your body where it would be in danger if movement should occur during assembly, installation, operation, maintaining, repairing of the implement.
-  Never place yourself between the tractor or ATV and implement while implement is in operation.
-  Disc blades are sharp! Do not allow discs to roll over or fall on any part of the body. Do not allow wrenches to slip when working near disc blades. Do not climb over machine above disc blades. Failure to stay clear of disc blade edges can result in serious personal injury.
-  Never use alcoholic beverages or drugs which can hinder alertness or coordination while operating this equipment. Consult your doctor about operating this machine while taking prescription medications.
-  Do not allow others to ride on the tractor or ATV with an operator. Riders are subject to injury such as being struck by foreign objects or being thrown off. Riders obstruct the operator's view resulting in unsafe operation. **Never allow anyone to ride on the implement!**
-  Before you operate the equipment, check over all pins, bolts and connections to be sure all are securely in place. Replace any damaged or worn parts immediately.
-  Do not allow anyone who is not familiar with the safety rules and operation instructions to use this equipment.
-  Never allow children to operate or be around equipment.
-  Know your controls and how to stop tractor or ATV, engine, and implement quickly in an emergency. Read this manual and the one provided with your tractor.
-  Keep alert and watch the front as well as the rear when working with equipment.
-  Do not operate close to ditches or creeks. Slow down when operating over rough ground or slopes.

SAFETY INFORMATION (continued)



When maneuvering close to buildings or passing through narrow areas, be sure to allow sufficient clearance for the implement and tractor or ATV.



When removing, or adjusting equipment, be sure that your feet are never under the implement.



Be careful to avoid catching the implement on stumps or other immovable objects.



Operate the implement with a tractor equipped with an approved Roll-Over Protective System (ROPS). Always wear your seat belt on tractors equipped with a ROPS. Serious injury or even death could result from falling off the tractor – particularly during a turnover when the operator could be pinned under the ROPS or the tractor. Keep foldable ROPS systems in “locked up” position at all times.



Avoid excessive speed during operation.



Make implement adjustments only when the implement is attached to the tractor.



Always ease the tractor or ATV into the load.



Watch for and avoid hidden obstructions, i.e., buried pipes, rocks, concrete piers, uneven concrete slabs, stumps, etc., when operating equipment.



Never operate tractor or ATV and implement under trees with low hanging limbs. Operators can be knocked off the tractor or ATV and then run over by the implement.



Always be sure the implement is in the proper position for transport.



Reduce speed when transporting mounted implements to avoid bouncing and momentary loss of steering control.

















Be a safe and courteous driver. Always yield to oncoming traffic in all situations, including narrow bridges, intersections, etc.



Do not exceed 10 mph (16 kph). Reduce speed on rough roads and surfaces.

SAFETY INSTRUCTIONS (continued)

-  Be certain the tractor or ATV is in neutral or park position before starting engine.
-  Take all possible precautions when leaving unit unattended: Disengage PTO, set parking brake, stop engine and remove key from ignition. Park in level area.
-  Pick up all rocks and other debris before operation. Enter new areas carefully. Never assume an area is clear.
Always Check!
-  Turn curves or go up or down hills only at a low speed and at a gradual steering angle. Make certain that at least 20% of the tractor's weight is on the front wheels to maintain safe steering. Slow down on rough or uneven surfaces, and loose gravel.
-  Never work under equipment unless it is blocked securely.
-  Keep all persons away from operator control area while performing adjustments, service, or maintenance.
-  Never replace hex bolts with less than grade five bolts unless otherwise specified, i.e. shear bolts. Refer to bolt torque chart for head identification marking.
-  Where replacement parts are necessary for periodic maintenance and servicing, genuine factory replacement parts must be used to restore your equipment to original specifications. The manufacturer will not claim responsibility for use of unapproved parts and/or accessories and other damages as a result of their use.
-  If equipment has been altered in any way from original design, the manufacturer does not accept any liability for injury or warranty.
-  Following operation, or when unhooking, stop the tractor or ATV, set the brakes, shut off the engine and remove the ignition keys.
-  Store the unit in an area away from human activity. Do not park equipment where it will be exposed to livestock for long periods of time. Damage and livestock injury could result.
-  Do not permit children to play on or around the stored unit.
-  Make sure all parked machines are on a hard, level surface and engage all safety devices.
-  If blocking is used, make sure it is solid and secure before leaving area.

SAFETY SIGNS



For Model FOD-16 Only

BE CAREFUL!

Use a clean, damp cloth to clean safety decals. Avoid spraying to close to decals when using a pressure washer; high-pressure water can enter through very small scratches or under edges of decals causing them to peel or come off.



-
- ✓ Keep children away from danger all day, every day.
 - ✓ Please work, drive, play, and live each day with care and concern for your safety and that of your family and fellow citizens.

REMEMBER:

If Safety Signs have been damaged, removed, become illegible or parts replaced without Signs, new Safety Signs must be applied. New Safety Signs are available from your authorized distributor or factory.

INSTRUCTIONS

TRACTOR/ATV REQUIREMENTS AND PREPARATION

The Model FOD-16 single gang disc and Model FOC-48 Culti-Packer are designed for 16 hp or larger garden tractors and ATV's with an engine size of 250 cc or more.

Both units are easy to pull and maneuver. They can be turned in tight areas.

The disc and culti-packer are easily flipped over so they can be transported over lawns or driveways without damage.

NOTE: The transport wheels are for use behind the tractor or ATV only. They are **NOT** designed for road use.

The large 16" diameter notched disc blades will pull easier than smaller diameter blades, yet will cut trash and penetrate the soil better.

The FOC-48 Culti-Packer will form a firm seedbed and will help reduce wind and water erosion. Each packer wheel is free to turn on the main shaft which rotates in bearing blocks. The later model FOC-48A has flange mounted ball bearings.



CAUTION

Be sure your tractor or ATV is in good condition. Read all the safety precautions and make sure all operators are familiar with the safety rules of operation.

PACKAGING

The Model FOD-16 disc is normally shipped on a single pallet. The two gangs will be pre-assembled. The main frame will have the wheels installed with the tongue assemble strapped to it. The gang bearings and hardware will be in a box along with the operator's manual.

The Model FOC-48 Culti-Packer is normally shipped on a single pallet. The unit is assembled except for the tongue which is strapped to it. The manual is tied to the unit.

ASSEMBLY – FOD-16 DISC

Preview the assembly instructions and the exploded views of the disc in your operator's manual and become familiar as to how the parts or assemblies go together.

Select an area for assembly that is clean and free from debris.

Stand to the side and cut the shipping bands using a pair of sheet metal shears. Remove the parts from the pallet. Open the box containing the gang bearings, hardware and operator's manual. Lay the main frame on its back so the bearing hangers are up. Match up the four sets of gang bearings.

NOTE: The two bearing cap halves only fit together properly one way. If mated incorrectly, there will be a gap between the two halves.

Lay a bearing half on each of two bearing hangers on one side of the unit. With the help of another person, set one of the gangs on the two bearing cap halves. Place the mating bearing caps on the gang units, install the 1/2 x 5 carriage bolts, and flange lock nuts. Leave the lock nuts loose so the bearings can be adjusted. Assemble the opposite side in the same manner. Slide the two gangs toward the center with about 1/4 inch between the two center blades. Snug the bearing lock nuts. Rotate the gangs and align the bearings by tapping them gently until the gangs rotate easily. Tighten the bearing bolts. Grease the bearings until grease appears at the ends of the bearings.

NOTE: These are cast bearings and require frequent, liberal greasing to keep dirt flushed from the bearings. Check the lubrication section of this manual.

Insert the tongue for either transport or discing and install the retaining pin.



DANGER

Disc blades are extremely sharp. Exercise extreme care when working on or near disc blades. Do not allow discs to roll over or fall on any bodily part. Do not allow wrenches to slip when working near disc blades and never push wrenches towards disc blades. Do not climb over machine above disc blades. Failure to stay clear of disc blade edges can result in serious personal injury.

ASSEMBLY – FOC-48 & FOC-48A CULTI-PACKER

The Culti-Packer is assembled. Insert the tongue and install the pin.

Grease the bearing blocks until grease appears. (Older FOC-48 Model only.) Grease at least once a day to keep dirt flushed from the bearing blocks.

The Model FOC-48A has ball bearings – **DO NOT** over grease these – once a day with one shot of grease.

INSTRUCTIONS (continued)

FLIPPING THE DISC FROM TRANSPORT TO DISCING POSITION AND VISE VERSA

Unhook the disc from the tractor drawbar and pull the tractor forward out of the way. Lift the disc tongue while placing one foot near the center of the unit to prevent it from rolling forward and allow it to come to rest in the vertical position. Remove the tongue retaining pin and reverse the tongue. Reinstall the retaining pin. (See Fig. A & B)

NOTE: Always remove the weight from the weight box before flipping the disc harrow.

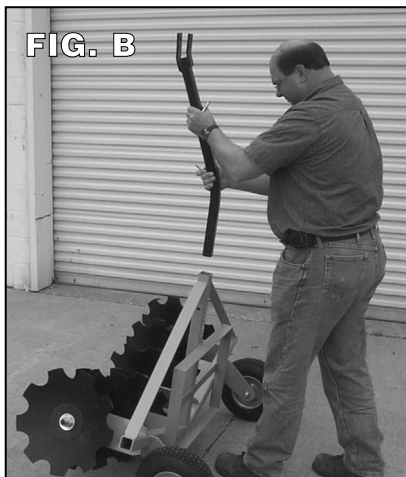
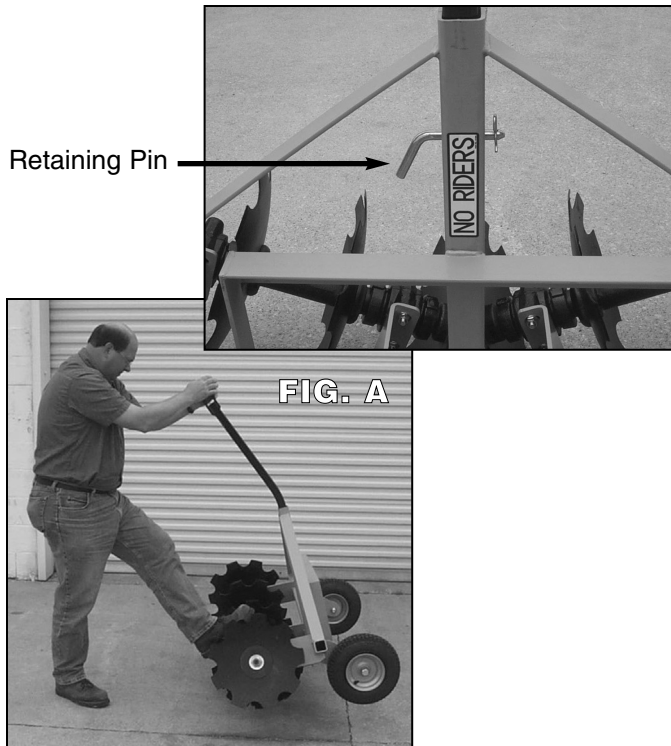

Place one foot on the inner axle bearing and pull the tongue downward into the discing position. (See Fig. C & D)

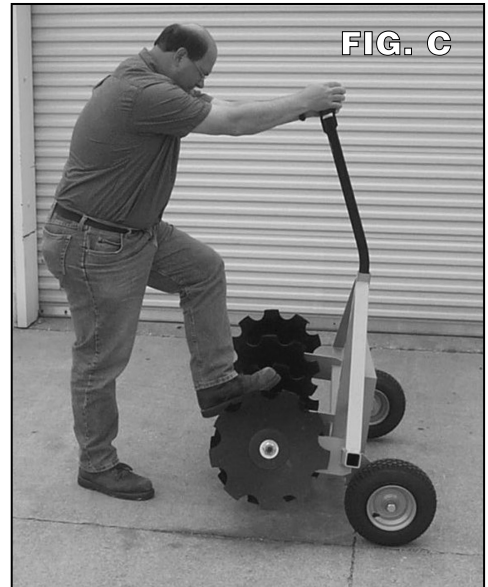

FLIPPING THE CULTI-PACKER FROM TRANSPORT TO WORKING POSITION AND BACK

Unhook the culti-packer from the tractor drawbar and drive the tractor out of the way.

The culti-packer is flipped in the same way as the FOD-16 disc. It is not necessary to remove the tongue.

OPERATING INSTRUCTIONS

OPERATION

The safe operation of the implement is the responsibility of the operator. The operator should be familiar with the implement, tractor (or ATV) and all safety practices before starting operation. Review and follow all the safety rules in this manual and those of the tractor or ATV.

FOD-16 DISC

Due to the sharp rotating blades, a responsible adult only (not a child) should do all the discing and transporting operations.

Inspect the area to be disced for stumps, stones, branches, or other foreign objects that could cause damage to the pulling vehicle or the disc. If objects cannot be cleared from the area (like stumps) then mark them clearly so the operator can avoid them.

The large 16" diameter notched disc blades will cut trash and penetrate the soil for good ground preparation. In sod or tough soil conditions, several passes may be necessary to work the soil to a satisfactory condition.

The Model FOD-16 disc frame has a weight box built in to add weight (up to three cement blocks). The extra weight will increase disc penetration.

It is recommended that a rubber tarp strap be placed over the cement blocks to secure them to the frame.

The disc can be operated at up to 5 mph. Under most conditions, 3 to 4 mph is a better operating speed. Operating too fast will not allow the blades to penetrate and greatly increase the chance of damage to the disc.

Successive passes should be made with the outer blade approximately 7 inches from the previous pass to match the blade spacing and to prevent ridging. In most cases, multiple passes will be required to achieve the desired soil preparation. It is recommended to straddle previous passes or work the second time over at an angle to avoid ridging and to mix the soil.

Never allow anyone to play near the unit and always store the unit in a safe secure place, preferable in a locked storage shed or fenced area. Never allow anyone to climb or ride on the unit for any reason.

FOC-48/FOC-48A CULTI-PACKER

The Culti-Packer will form a firm seedbed and help maximize seed to soil contact for better germination. The packer wheels will pulverize hard clods and firm the soil to help prevent wind and water erosion.

In most soil conditions, 3 to 4 mph is the recommended operation speed. If the ground is fairly smooth, you can operate at up to 6 mph.

INSTRUCTIONS FOR BOTH UNITS

UNEVEN TERRAIN –



WARNING

- Do not operate on steep slopes.
- Do not stop, start or change directions suddenly on slopes.
- Use extreme care and reduce ground speed on slopes and rough terrain.
- Watch for hidden hazards on the terrain during operation.

Pass diagonally through sharp dips and avoid sharp drops to prevent "hanging up" tractor and implement.

Practice will improve your skills in maneuvering rough terrain.



CAUTION

- Keep alert and watch the front as well as the rear when working with equipment.
- Do not operate close to ditches or creeks.
- Slow down when operating over rough ground. Avoid excessive speeds!



CAUTION

When maneuvering close to buildings or passing through narrow areas, be sure to allow sufficient clearance for the implement and tractor or ATV.

OWNER SERVICE

The information in this section is written for operators who possess basic mechanical skills. For your protection, read and follow all safety information in this manual.

WARNING

Always stop the tractor or ATV, set brake, shut off engine, and remove key before attempting to service. Never leave equipment unattended with engine running.

LUBRICATION INFORMATION

Use a lithium grease of NO. 2 consistency with a MOLY (molybdenum disulfide) additive for all locations. Be sure to clean fittings thoroughly before attaching grease gun.

The Model **FOC-48** has bearing blocks on each end of the main shaft. Once a day lubrication with several shots of grease will flush the dirt out and keep the shaft lubricated.

The Model **FOC-48A** has ball bearings on the main shaft. One shot of grease once a day is recommended. **DO NOT OVER GREASE** ball bearings – this can blow the seals and ruin the bearings.

The Model **FOD-16** disc uses greasable cast iron bearings for long trouble free operation. Each bearing half has a grease zerk fitting. It is important that both halves of each bearing set be greased daily during use to keep dirt flushed out.

NOTE: Cast iron bearings have a slightly rough finish. Initially these rough spots will be ground off and a smooth bearing surface will result. It is recommended that when first using the disc, that the bearings be greased several times during use to flush out grease that has some of the ground particles. After this, once a day lubrication is sufficient.

These bearings cannot be damaged from over lubrication.

MAINTENANCE

Periodically check all bolts to make sure they are tight.

Replace any worn or damaged parts immediately.

NOTE: TIGHTEN ALL 1" BLADE AXLE NUTS TO 300 FOOT-POUNDS OF TORQUE.

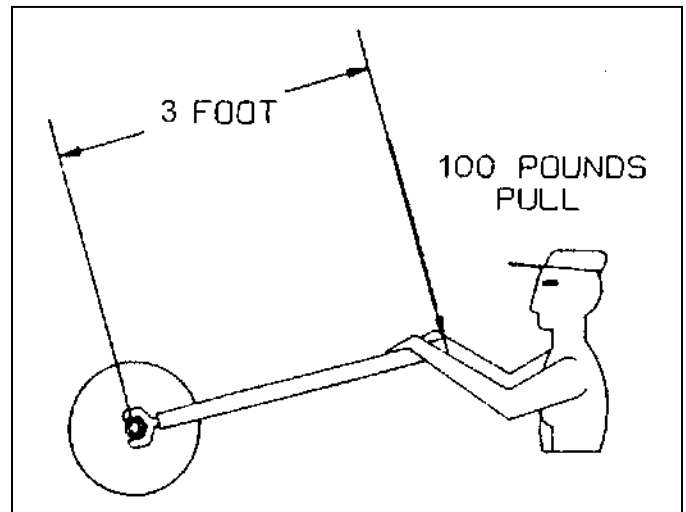

FIG. E Example of 300 foot-pounds of torque.

STORAGE

At the end of the working season or when the implement will not be used for a long period, it is good practice to clean off any dirt or grease that may have accumulated on the implement and any of the moving parts.

Inspect the implement for loose, damaged or worn parts and adjust or replace if needed.

Repaint parts where paint is worn or scratched to prevent rust. Replace any safety signs if damaged or missing.

Store the unit in a shed or under a tarpaulin to protect it from the weather. The disc blades or packer wheels and tires should rest on boards, or some other object, to keep them out of the soil.

Store implement in a clean, dry place away from human activity or livestock.

FOD-16 PARTS LIST

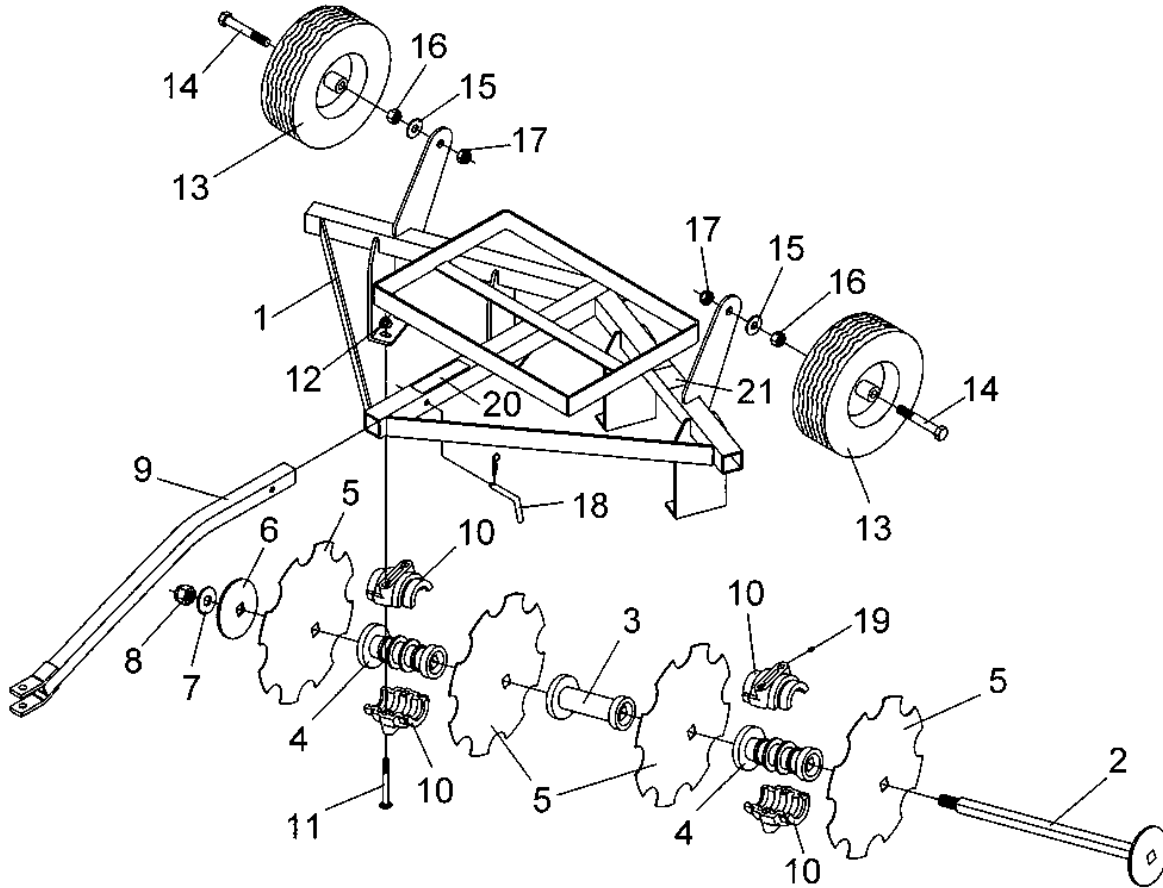

Ref. No.	Part No.	Description	No. Req'd.
1	940421	Main Frame Weldment	1
2	940282	Disc Axle Weldment	2
3	940283	Disc Spool (Plain)	2
4	940284	Disc Spool (Ribbed)	4
5	940297	Disc Blade (Notched)	8
6	940318	Disc, Back-Up	2
7	2501001	Washer 1" Flat	2
8	2500045	Nut 1"-8NC Hex Nylock	2
9	940430	Tongue Weldment	1
10	940293	Bearing Cap (Half)	8
11	2503268	Bolt 1/2"-13NC x 5" Carriage Head Gr. 5	8
12	2500040	Nut 1/2"-13NC Whiz Flange Hex	8
13	341935	Wheel Assembly 410/350 x 6	2
14	2503033	Bolt 3/4"-10NC x 5" Hex Head Gr. 2	2
15	2501002	Washer 3/4" Flat	2
16	2500002	Nut 3/4"-10NC Full Hex	2
17	2500075	Nut 3/4"-10NC Hex Jam Nylock	2
18	343180	Shift Pin (1/2" x 3") w/Hairclip Pin	1
19	2504208	Grease Zerk M6 x 1.0	8
20	101065	Safety Sign - No Riders	1
21	101195	Safety Sign - Warning (Sharp Blades)	1

FOC-48 PARTS LIST

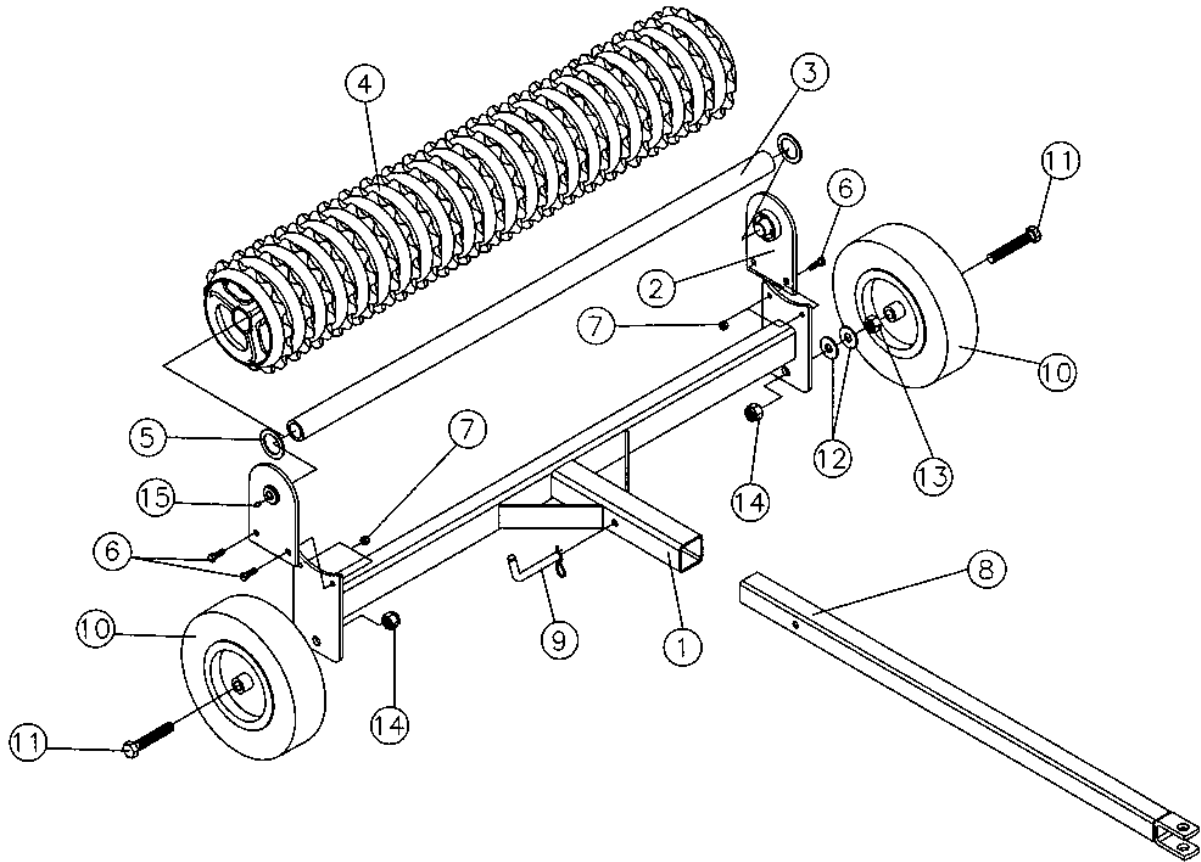

Ref. No.	Part No.	Description	No. Req'd.
1	940401	Frame Weldment, FOC-48	1
2	940416	Plate Weldment, FOC-48	2
3	940410	Axle Tube, FOC-48	1
4	940415	Packer Wheel	22
5	2504111	Machinery Bushing 1.75 x 10 Ga.	2
6	2503178	Bolt, Carriage 3/8"-16NC x 1 1/4" Gr.2	4
7	2500081	Nut, Hex 3/8"-16NC Whiz Flange	4
8	940405	Tongue Weldment, FOC-48	1
9	343180	Shift Pin (1/2" x 3") w/Hairclip Pin	1
10	341935	Wheel Assembly, 410/350 x 6	2
11	2503033	Bolt, Hex 3/4"-10NC x 5" Gr.2	2
12	2501002	Washer, 3/4" Medium Flat	4
13	2500002	Nut, Hex 3/4"-10NC	2
14	2500075	Nut, 3/4"-10NC Hex Jam Nylock	2
15	2504049	Zerk, Drive 5/16"	2
NS	101065	Safety Sign - No Riders	1

FOC-48A PARTS LIST

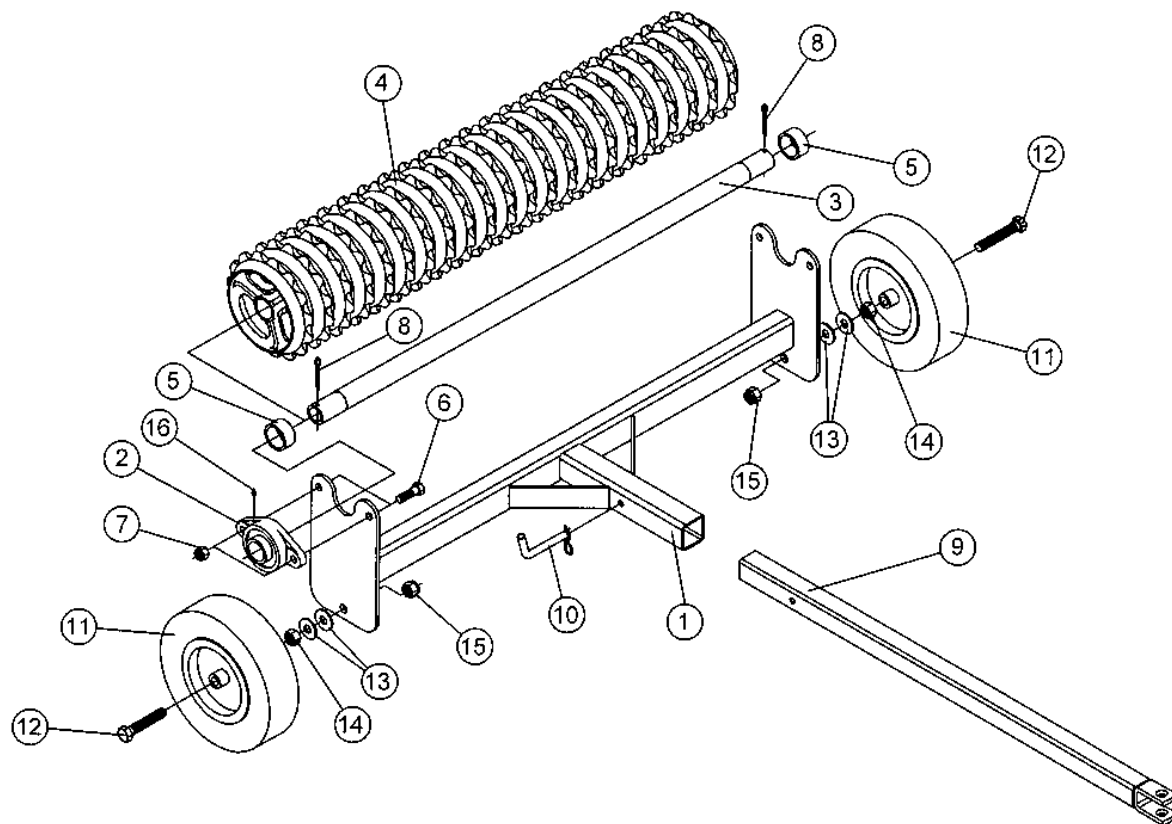

Ref. No.	Part No.	Description	No. Req'd.
1	940436	Frame Weldment, FOC-48A	1
2	2505048	Flanged Bearing	2
3	940437	Axle Tube, FOC-48A	1
4	940415	Packer Wheel	22
5	940438	Collar, Spacer	2
6	2503152	Bolt 5/8"-11NC x 2" Hex Head Gr.5	4
7	2500041	Nut 5/8"-11NC Nylock Hex	4
8	2504005	Cotter Pin 3/16" x 2 1/2"	2
9	940405	Tongue Weldment, FOC-48	1
10	343180	Shift Pin (1/2" x 3") w/Hairclip Pin	1
11	341935	Wheel Assembly, 410/350 x 6	2
12	2503033	Bolt, Hex 3/4"-10NC x 5" Gr.2	2
13	2501002	Washer, 3/4" Medium Flat	4
14	2500002	Nut, Hex 3/4"-10NC	2
15	2500075	Nut, 3/4"-10NC Hex Jam Nylock	2
16	2504049	Zerk, Drive 5/16"	2
NS	101065	Safety Sign - No Riders	1

SAFETY REQUIREMENTS

AVOID ACCIDENTS BY FOLLOWING ALL OF THE SAFETY REQUIREMENTS LISTED BELOW.

- Machinery should be operated only by those who are responsible and are authorized to do so.
- Stop the engine, lower all equipment, lock the brakes, and remove the ignition key before dismounting from the tractor.
- Never stand between tractor and implement while tractor is being backed to hitch.
- Loose fitting clothing should not be worn, to avoid catching on various parts.
- Detach implement in area where children normally do not play.
- When performing adjustments or maintenance on an implement, first lower it to the ground or block it securely at a workable height.
- Only a qualified operator should be permitted on tractor when in operation; no riders allowed.
- Make certain everyone is in the clear before starting tractor or raising or lowering equipment.
- Operate the tractor and implement only while seated in the driver's seat.
- Reduce speed when transporting mounted implements to avoid bouncing and momentary loss of steering control.
- A heavy load can cause instability of the tractor. Use extreme care during road travel. Slow down on turns and watch out for bumps. Tractor may need front counter-weights to counter-balance the weight of the implement.
- Reduce speed on hillsides or curves so there is no danger of tipping.
- Avoid driving too close to the edge of ditches or creeks.
- Do not transport implement on public roads without reflectors and slow moving vehicle emblem in daylight and with approved warning lights at night and other periods of poor visibility.
- Due to the width of some implements, use extra caution on highways, farm roads, and when approaching gates.
- Always be sure the implement is in the proper position for transport.
- Keep alert and watch the front as well as the rear when working with the implement.

OWNER'S/ OPERATOR'S MANUAL

MODEL NO.'s

FOD-16

FOC-48

FOC-48A

**WHEN ORDERING REPAIR
PARTS, ALWAYS GIVE THE
FOLLOWING INFORMATION:**

1. PART NUMBER
2. PART DESCRIPTION
3. MODEL NUMBER
4. NAME OF ITEM

MAY 2017

FLIP-OVER SINGLE GANG DISC and 4 FT. CULTI-PACKER

**Please work, drive, play and live each day
with care and concern for your safety and
that of your family and fellow citizens.**

**MAKE EVERY DAY
A HOLIDAY
FROM ACCIDENTS!**

FARM STAR

P.O. BOX 100 LITCHFIELD, IL 62056-0100 (217) 324-5973
WEB: <http://www.farmstar.com> E-MAIL: sales@farmstar.com