

OWNER'S/ OPERATOR'S MANUAL

**MODEL NO.
720**

CAUTION

For Safe Operation
Read Rules And
Instructions Carefully

SINO LEEINGLES, PIDA AYUDA
A AIGUIEN QUE SI LO LEA
PARA QUE LE TRADUZCA LAS
MEDIDAS DE SEGURIDAD.

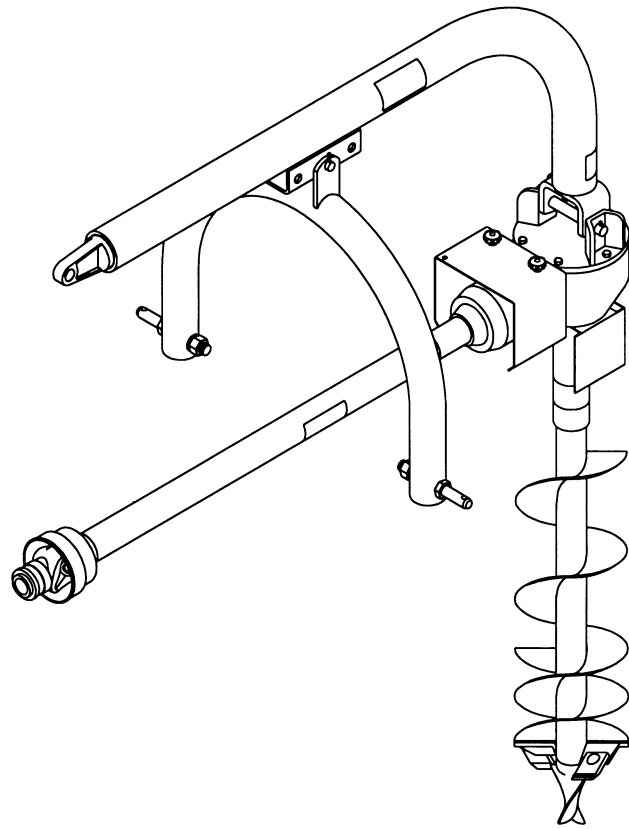

HEAVY DUTY 3-PT. MOUNTED POST HOLE DIGGER

**Safety Instructions
Tractor Preparation
Operating Instructions**

**Assembly & Mounting
Maintenance
Repair Parts**

CAUTION

**THE FOLLOWING SAFETY PRECAUTIONS SHOULD BE THOROUGHLY UNDERSTOOD
BEFORE ATTEMPTING TO BEGIN ASSEMBLING THIS MACHINE**

1. Select an area for assembly that is clean and free of any debris which might cause persons working on the assembly to trip.
2. Do not lift heavy parts or assemblies. Use crane, jack, tackle, fork trucks or other mechanical devices.
3. Preview the assembly instructions in your operator's manual before proceeding further.
4. If the assembly instructions call for parts or assemblies to be blocked up, use only blocking material that is in good condition and is capable of handling the weight of the assembly to be blocked. Also insure that the blocking material is on a clean, dry surface.
5. Never put hands, or any part of body, under blocked up assemblies if at all possible.
6. After completing assembly, thoroughly inspect the machine to be sure that all nuts, bolts, hydraulic fittings or any other fastened assemblies have been thoroughly tightened.
7. Before operating the machine, thoroughly read the operation section of your operator's manual.
8. Before operating, read the maintenance section of your operator's manual to be sure that any parts requiring lubrication, such as gearboxes, are full, to avoid any possible damage.
9. **Before operating equipment – If you have any questions regarding the proper assembly or operation, contact your dealer or representative.**

TABLE OF CONTENTS

WARRANTY	2
SAFETY INFORMATION	3
SAFETY SIGNS	11
PREPARATION INSTRUCTIONS	12
OPERATING INSTRUCTIONS	15
OWNER SERVICE	18
TROUBLE-SHOOTING GUIDE	19
PARTS LISTS	21
DOWN FORCE KIT	26/27

SINO LEEINGLES, PIDA AYUDA A AIGUIEN QUE SI LO LEA PARA QUE LE TRADUZCA LAS MEDIDAS DE SEGURIDAD.

STATEMENT OF POLICY

It is the policy of Worksaver, Inc. to improve its products where it is possible and practical to do so. Worksaver, Inc. reserves the right to make changes or improvements in design and construction at any time, without incurring the obligation to make these changes on previously manufactured units.

TO THE OWNER:

Read this manual before using your Post Hole Digger. This manual is provided to give you the necessary operating and maintenance instructions for keeping your Post Hole Digger in top operating condition. Please read this manual thoroughly. Understand what each control is for and how to use it. Observe all safety signs on the machine and noted throughout the manual for safe operation of implement. Keep this manual handy for ready reference.

Like all mechanical products, it will require cleaning and upkeep.

Use only genuine Worksaver, Inc. service parts. Substitute parts will void the warranty and may not meet standards required for safe and satisfactory operation. Record the model and serial number of your Attachment here:

Model: _____ Serial Number: _____

RETAIL CUSTOMER'S RESPONSIBILITY

It is the Retail Customer and/or Operator's responsibility to read the Operator's Manual, to operate, lubricate, maintain, and store the product in accordance with all instructions and safety procedures. Failure of the operator to read the Operator's Manual is a misuse of this equipment.

It is the Retail Customer and/or Operator's responsibility to inspect the product and to have any part(s) repaired or replaced when continued operation would cause damage or excessive wear to other parts or cause a safety hazard.

It is the Retail Customer's responsibility to deliver the product to the authorized Worksaver Dealer, from whom he purchased it, for service or replacement of defective parts which are covered by warranty. Repairs to be submitted for warranty consideration must be made within forty-five (45) days of failure.

It is the Retail Customer's responsibility for any cost incurred by the Dealer for traveling to or hauling of the product for the purpose of performing a warranty obligation or inspection.

LIMITED WARRANTY

Worksaver warrants to the original purchaser of any new Post Hole Digger (Model 720), that the equipment be free from defects in material and workmanship for a period of six (6) months for non-commercial, state, and municipalities. Commercial use warranty, 90 days on unit and driveline, one year on gearbox from date of sale.

Replacement or repair parts installed in the equipment covered by this warranty are warranted for ninety (90) days from the date of purchase of such part or to the expiration of the applicable new equipment warranty period, whichever occurs later.

Such parts shall be provided at no cost to the user during regular working hours. Worksaver reserves the right to inspect any equipment or parts which are claimed to have been defective in material or workmanship.

ADDITIONS TO LIMITED WARRANTY

In addition to the Standard Limited Warranty printed above, **Worksaver, Inc.** provides:

1. Five years' (60 months) warranty on the gearbox and,
2. One year (12 months) on the driveline if:

all of these components have been properly maintained and lubricated and that they have not been subjected to abuse or misuse.

NOTICE: Worksaver is NOT responsible for damage to augers caused by hitting underground objects (rocks, roots, etc.) or for bent augers caused by moving the tractor with the auger in the ground.

DISCLAIMER OF IMPLIED WARRANTIES & CONSEQUENTIAL DAMAGES

Worksaver's obligation under this warranty, to the extent allowed by law, is in lieu of all warranties, implied or expressed, including implied warranties of merchantability and fitness for a particular purpose and any liability for incidental and consequential damages with respect to the sale or use of the items warranted. Such incidental and consequential damages shall include but not be limited to: transportation charges other than normal freight charges; cost of installation other than cost approved by Worksaver; duty; taxes; charges for normal service or adjustments; loss of crops or any other loss of income; rental of substitute equipment, expenses due to loss, damage, detention or delay in the delivery of equipment or parts resulting from acts beyond the control of Worksaver.

THIS WARRANTY SHALL NOT APPLY:

1. To vendor items which carry their own warranties, such as hydraulic cylinders, tires, and tubes.
2. If the unit has been subjected to misapplication, abuse, misuse, negligence, fire or other accident.
3. If parts not made or supplied by Worksaver have been used in connection with the unit, if, in sole judgement of Worksaver such use affects its performance, stability, or reliability.
4. If the unit has been altered or repaired outside of an authorized Worksaver dealership in a manner which, in the sole judgement of Worksaver affects its performance, stability or reliability.
5. To normal maintenance service and normal replacement items such as gearbox lubricant, hydraulic fluid, worn blades, or to normal deterioration of such things as belts and exterior finish, due to use or exposure.
6. To expendable or wear items such as teeth, chains, center points, belts, springs and other items that in the company's sole judgement is a wear item.

NO EMPLOYEE OR REPRESENTATIVE OF WORKSAVER IS AUTHORIZED TO CHANGE THIS WARRANTY IN ANY WAY OR GRANT ANY OTHER WARRANTY UNLESS SUCH CHANGE IS MADE IN WRITING AND SIGNED BY WORKSAVER'S SERVICE MANAGER, POST OFFICE BOX 100, LITCHFIELD, ILLINOIS 62056-0100.

To the Owner/Operator/Dealer

All implements with moving parts are potentially hazardous. There is no substitute for a cautious, safe-minded operator who recognizes the potential hazards and follows reasonable safety practices. The manufacturer has designed this implement to be used with all its safety equipment properly attached to minimize the chance of accidents.

BEFORE YOU START!!

**Read the safety messages on the implement and shown in your manual.
Observe the rules of safety and common sense!**



THIS SYMBOL MEANS

- ATTENTION!
- BECOME ALERT!
- YOUR SAFETY IS INVOLVED!

THIS SAFETY ALERT SYMBOL IDENTIFIES IMPORTANT SAFETY WARNING MESSAGES. CAREFULLY READ EACH WARNING MESSAGE THAT FOLLOWS. FAILURE TO UNDERSTAND AND OBEY A SAFETY WARNING, OR RECOGNIZE A SAFETY HAZARD, COULD RESULT IN AN INJURY OR DEATH TO YOU OR OTHERS AROUND YOU. THE OPERATOR IS ULTIMATELY RESPONSIBLE FOR THE SAFETY OF HIMSELF, AS WELL AS OTHERS, IN THE OPERATING AREA OF THE TRACTOR AND ATTACHED EQUIPMENT.

UNDERSTAND SIGNAL WORDS

Note the use of the signal words **DANGER**, **WARNING** and **CAUTION** with the safety messages. The appropriate signal word for each has been selected using the following guidelines:

DANGER: Indicates an imminently hazardous situation that, if not avoided, will result in death or serious injury. This signal word is to be limited to the most extreme situations typically for machine components which, for functional purposes, cannot be guarded.

WARNING: Indicates a potentially hazardous situation that, if not avoided, could result in death or serious injury, and includes hazards that are exposed when guards are removed. It may also be used to alert against unsafe practices.

CAUTION: Indicates a potentially hazardous situation that, if not avoided, may result in minor or moderate injury. It may also be used to alert against unsafe practices.

If you have questions not answered in this manual or require additional copies or the manual is damaged, please contact your dealer or the manufacturer directly.

IMPORTANT SAFETY INFORMATION!

Working with unfamiliar equipment can lead to careless injuries. Read this manual, and the manual for your tractor, before assembly or operating, to acquaint yourself with the machines. It is the implement owner's responsibility, if this machine is used by any person other than yourself, is loaned or rented, to make certain that the operator, prior to operating:

1. Reads and understands the operator's manuals.
2. Is instructed in safe and proper use.





The use of this equipment is subject to certain hazards which cannot be protected against by mechanical means or product design. All operators of this equipment must read and understand this entire manual, paying particular attention to safety and operating instructions, prior to using. If there is something in this manual you do not understand, ask your supervisor, or your dealer, to explain it to you.

SAFETY INSTRUCTIONS (continued)





EQUIPMENT SAFETY GUIDELINES

-  Safety of the operator is one of the main concerns in designing and developing a new piece of equipment. Designers and manufacturers build in as many safety features as possible. However, every year many accidents occur which could have been avoided by a few seconds of thought and a more careful approach to handling equipment. You, the operator, can avoid many accidents by observing the following precautions in this section. To avoid personal injury, study the following precautions and insist those working with you, or for you, follow them.

-  In order to provide a better view, certain photographs or illustrations in this manual may show an assembly with a safety shield removed. However, equipment should never be operated in this condition. Keep all shields in place. If shield removal becomes necessary for repairs, replace the shield prior to use.

-  Replace any CAUTION, WARNING, DANGER or instruction safety sign that is not readable or is missing. Location of such safety signs is indicated in this booklet.

-  Never use alcoholic beverages or drugs which can hinder alertness or coordination while operating this equipment. Consult your doctor about operating this machine while taking prescription medications.

-  Review the safety instructions with all users annually.

-  This equipment is dangerous to children and persons unfamiliar with its operation. The operator should be a responsible adult familiar with farm machinery and trained in this equipment's operations. **Do not allow persons to operate or assemble this unit until they have read this manual and have developed a thorough understanding of the safety precautions and of how it works.**

-  To prevent injury or death, use a tractor equipped with a Roll-Over Protective System (ROPS). Keep foldable ROPS systems in "locked up" position at all times. Do not paint over, remove or deface any safety signs or warning signs on your equipment. Observe all safety signs and practice the instruction on them.

-  Never exceed the limits of a piece of machinery. If its ability to do a job, or to do so safely, is in question - **DON'T TRY IT.**





-  Do not modify the equipment in any way. Unauthorized modification may impair the function and/or safety and could affect the life of the equipment.

-  In addition to the design and configuration of this implement, including Safety Signs and Safety Equipment, hazard control and accident prevention are dependent upon the awareness, concern, prudence, and proper training of personnel involved in the operation, transport, maintenance, and storage of the machine. Refer also to Safety Messages and Operation Instructions in each of the appropriate sections of the Tractor and Implement Manuals. Pay close attention to the Safety Signs affixed to the Tractor and the Implement.





SAFETY INSTRUCTIONS (continued)



SAFETY SIGNS







-  Keep safety signs clean and legible at all times.
-  Replace safety signs that are missing or have become illegible.
-  Replaced parts that displayed a safety sign should also display the current sign.
-  Safety signs are available from your Distributor or Dealer Parts Department or the factory.

How to Install Safety Signs:

-  Be sure that the installation area is clean and dry. Be sure temperature is above 50°F (10°C).
-  Decide on the exact position before you remove the backing paper.
-  Remove the smallest portion of the split backing paper. Align the sign over the specified area and carefully press the small portion with the exposed sticky backing in place.
-  Slowly peel back the remaining paper and carefully smooth the remaining portion of the sign in place. Small air pockets can be pierced with a pin and smoothed out using the piece of sign backing paper.









SAFETY TRAINING

-  Safety is a primary concern in the design and manufacture of our products. Unfortunately, our efforts to provide safe equipment can be wiped out by a single careless act of an operator. It is the operator's responsibility to read and understand ALL Safety and Operating instructions in the manual and to follow these. Accidents can be avoided.
-  In addition to the design and configuration of equipment, hazard control and accident prevention are dependent upon the awareness, concern, prudence and proper training of personnel involved in the operation, transport, maintenance and storage of equipment.
-  Working with unfamiliar equipment can lead to careless injuries. Read this manual, and the manual for your tractor, before assembly or operating, to acquaint yourself with the machines. It is the implement owner's responsibility, if this machine is used by any person other than yourself, is loaned or rented, to make certain that the operator, prior to operating:
 1. Reads and understands the operator's manuals.
 2. Is instructed in safe and proper use.
-  Know your controls and how to stop tractor, engine, and implement quickly in an emergency. Read this manual and the one provided with your tractor.
-  Train all new personnel and review instructions frequently with existing workers. A person who has not read and understood all operating and safety instructions is not qualified to operate the machine. An untrained operator exposes himself and bystanders to possible serious injury or death.
-  Do not allow children to operate this machine.

SAFETY INSTRUCTIONS (continued)







PREPARATION

-  Personal protection equipment including hard hat, safety glasses, safety shoes, and gloves are recommended during assembly, installation, operation, adjustment, maintaining, repairing, removal, or moving the implement. Do not allow long hair, loose fitting clothing or jewelry to be around moving parts.
-  **PROLONGED EXPOSURE TO LOUD NOISE MAY CAUSE PERMANENT HEARING LOSS!**
Tractors with or without implements attached can often be noisy enough to cause permanent, partial hearing loss. We recommend that you wear hearing protection on a full-time basis if the noise in the Operator's position exceeds 80db. Noise over 85db on a long-term basis can cause severe hearing loss. Noise over 90db adjacent to the Operator over a long-term basis may cause permanent, total hearing loss. **NOTE:** Hearing loss from loud noise (from tractors, chain saws, radios, and other such sources close to the ear) is cumulative over a lifetime without hope of natural recovery.
-  Clear area of stones, branches or other debris that might be thrown or entangled, causing injury or damage.
-  Operate only in daylight or good artificial light.
-  Make sure driveline spring-activated locking pin or balls operate freely and are seated firmly in tractor PTO stub shaft groove.
-  Ensure that all safety shielding and safety signs are properly installed and in good condition.



OPERATIONAL SAFETY

-  This Post Hole Digger was designed for one-man operation from the tractor seat. It is the responsibility of the operator to see that no one is within twenty-five feet (25') of the digger when it is started. Do not operate the digger with another person near, or in contact with, any part of the digger, PTO driveline, or auger. Serious personal injury or death may result if any attempt is made to assist digger operation by hand.
-  Most accidents occur because of neglect or carelessness. Keep all helpers and bystanders twenty-five feet (25') from an operating digger. Only properly trained people should operate this machine. It is recommended the tractor be equipped with a Rollover Protection System (ROPS) and a seat belt that is used. Always stop the PTO, set brake, shut off the tractor engine, remove the tractor key, and allow auger to come to a complete stop before dismounting tractor. Never leave equipment unattended with the tractor running.
-  All things with moving parts are potentially hazardous. There is no substitute for a cautious, safe-minded operator who recognizes potential hazards and follows reasonable safety practices. The manufacturer has designed this digger to be used with all its safety equipment properly attached, to minimize the chance of accidents. Study this manual to make sure you have all safety equipment attached.
-  If a safety shield or guard is removed for any reason, it must be replaced before the machine is again operated. Always use, and maintain in place, all power take off guards furnished with the tractor as well as the power take off guards and shields furnished with the digger.

SAFETY INSTRUCTIONS (continued)



OPERATIONAL SAFETY (continued)



This digger is designed for use only on tractors with 540 RPM power take off.



When the use of hand tools is required to perform any part of assembly, installation, adjustment, maintaining, repairing, removal, or moving the digger, be sure the tools used are designed and recommended by the tool manufacturer for that specific task.



Never place yourself between the tractor and digger while implement is in operation.



Do not walk or work under a raised digger or attachment unless it is securely blocked or held in position. Do not depend on the tractor hydraulic system to hold the digger or attachment in place.



A heavy load can cause instability of the tractor. Use extreme care during travel. Slow down on turns and watch out for bumps. The tractor may need front counter-weights to counter-balance the weight of the digger.



Never use alcoholic beverages or drugs which can hinder alertness or coordination while operating this equipment. Consult your doctor about operating this machine while taking prescription medications.



Do not allow riders on the digger or tractor at any time. There is no safe place for any riders.



Before you operate the digger, check over all pins, bolts and connections to be sure all are securely in place. Replace any damaged or worn parts immediately.



Consult local utility companies to make certain there are no buried gas lines, electrical cables, etc., in the work area before beginning operation.



Do not allow anyone who is not familiar with the safety rules and operation instructions to use this Post Hole Digger.



Never allow children to operate or be around this digger.



Use stabilizer bars, adjustable sway chains, or sway blocks on your tractor lift arms to keep the Post Hole Digger from swinging side to side. Adjust as tightly as practical for best performance.



Never replace the shear bolt OR auger retaining bolt with any length other than what is specified in this manual. A longer, or protruding fastener is more likely to grab loose clothing or gloves which can result in serious injury or death.



Do not operate digger on steep hillsides. When digging on uneven or hilly terrain, position the tractor with the Post Hole Digger uphill. With the Post Hole Digger downhill, the tractor could tip when attempting to pull the auger from its hole.



Never position the auger point by hand or with any tool when the tractor is running.













Never position the auger point by putting your hands on the auger, gearbox, boom, or driveline.

SAFETY INSTRUCTIONS (continued)





OPERATIONAL SAFETY (continued)

-  Inspect the entire machine periodically as indicated in the Maintenance Section of this manual. Look for loose fasteners, worn or broken parts, pinched hydraulic hoses, and leaky or loose fittings. Make sure all pins have cotter pins and washers. Serious injury may occur from not maintaining this machine in good working order.
-  To prevent rapid wear of U-Joints and possible failure of drivelines, never lift auger point more than 12" off the ground with PTO operating.
-  To prevent possible instantaneous driveline failure, never move digger from hole-to-hole or transport while auger is rotating. This could lead to injury from flying pieces of the failed driveline.
-  Keep hands, feet, hair, jewelry, and clothing, away from all moving and/or rotating parts.
-  To prevent entanglement and possible serious injury or death, never use body weight to try to push auger into the ground.
-  Worn edges or a slightly rounded point can seriously effect auger penetration. Check for wear before each use, replace as necessary.
-  Do not shovel dirt away from a rotating auger as the shovel can be caught and thrown by the auger.
-  Do not operate the Post Hole Digger without all safety shields and guards in place.
-  Take all possible precautions when leaving unit unattended: Disengage PTO, set parking brake, stop engine and remove key from ignition. Park in level area.
-  Always use care when operating a Post Hole Digger.













MAINTENANCE SAFETY

-  Good maintenance is your responsibility. Poor maintenance is an invitation to trouble.
-  Follow good shop practices.
 - Keep service area clean and dry.
 - Be sure electrical outlets and tools are properly grounded.
 - Use adequate light for the job at hand.
-  Before working on this machine, drive to a level area, disengage the PTO, lower implement (or if working underneath, raise and block securely), shut off the engine, set the brakes, and remove the ignition keys.

SAFETY INSTRUCTIONS (continued)



MAINTENANCE SAFETY (continued)

-  Personal protection equipment including hard hat, safety glasses, safety shoes, and gloves are recommended during assembly, installation, operation, adjustment, maintaining, repairing, removal, or moving the digger. Do not allow long hair, loose fitting clothing or jewelry to be around moving parts.
-  Always use two people to handle heavy, unwieldy components during assembly, installation, removal, or moving the digger.
-  Never work under equipment unless it is blocked securely. Never depend on hydraulic system to keep implement in raised position.
-  Keep all persons away from operator control area while performing adjustments, service, or maintenance.
-  Always use personal protection devices such as eye, hand and hearing protectors, when performing any service or maintenance.
-  Periodically tighten all bolts, nuts and screws and check that all cotter pins are properly installed to ensure unit is in a safe condition.
-  When completing a maintenance or service function, make sure all safety shields and devices are installed before placing unit in service.
-  Where replacement parts are necessary for periodic maintenance and servicing, genuine factory replacement parts must be used to restore your equipment to original specifications. The manufacturer will not claim responsibility for use of unapproved parts and/or accessories and other damages as a result of their use.
-  If equipment has been altered in any way from original design, the manufacturer does not accept any liability for injury or warranty.
-  Never use your hands to locate a hydraulic leak on attachments. Use a small piece of cardboard or wood. Hydraulic fluid escaping under pressure can penetrate the skin. Openings in the skin and minor cuts are susceptible to infection from hydraulic fluid. If injured by escaping hydraulic fluid, see a doctor at once. Gangrene and death can result. Without immediate medical treatment, serious infection and reactions can occur.











Safety is a primary concern in the design, manufacture, sale, and use of Post Hole Diggers. As manufacturers of Post Hole Diggers, we want to confirm to you, our customers, our concern for safety.

Our current production machines include, as standard equipment, guards or shields for auger adapters, drivelines, input shafts, and safety signs. Older machines can be retrofitted to add these new guards or shields and, of course, safety signs. If you have an older machine which does not have current standard safety equipment, please contact your dealer about bringing your machine up to the current level of safety.

SAFETY INSTRUCTIONS (continued)







TRANSPORT SAFETY

-  Comply with state and local laws governing highway safety and movement of farm machinery on public roads.
-  The use of flashing amber lights is acceptable in most localities. However, some localities prohibit their use. Local laws should be checked for all highway lighting and marking requirements.
-  When driving the tractor and equipment on the road or highway under 20 mph (32 kph) at night or during the day, use flashing amber warning lights and a slow moving vehicle (SMV) identification emblem.
-  Always be sure the implement is in the proper raised position for transport.
-  Reduce speed when transporting mounted implements to avoid bouncing and momentary loss of steering control.
-  Plan your route to avoid heavy traffic. Watch for traffic when operating near or crossing roadways.
-  Do not drink and drive!
-  Turn curves or go up or down hills only at a low speed and at a gradual steering angle. Make certain that at least 20% of the tractor's weight is on the front wheels to maintain safe steering. Slow down on rough or uneven surfaces, and loose gravel.
-  Use extreme care and maintain minimum ground speed when transporting on hillside, over rough ground and when operating close to ditches or fences. Be careful when turning sharp corners.
-  Never allow riders on either tractor or implement. Falling off can kill.
-  Be a safe and courteous driver. Always yield to oncoming traffic in all situations, including narrow bridges, intersections, etc.



STORAGE SAFETY

-  Following operation, or when unhooking, stop the tractor, set the brakes, disengage the PTO, shut off the engine and remove the ignition keys.
-  Do not park equipment where it will be exposed to livestock for long periods of time. Damage and livestock injury could result.
-  Do not permit children to play on or around the stored unit.
-  Make sure all parked machines are on a hard, level surface and engage all safety devices.

SAFETY SIGNS AND DECALS

NOTICE!
GEARBOX SHIPPED WITHOUT OIL

Fill to proper level with EP-90 gear lubricant. READ operator's manual.

101188

POST HOLE DIGGER INSTRUCTIONS

1. Fill gearbox to the inspection hole with number 90 weight transmission grease. Check often.
2. Grease universal joints regularly. Check often.
3. Attach stabilizer bars to prevent side swing.
4. Replace shear bolt only with common grade #2 bolts. The use of a hard shear bolt voids all warranty.
5. Disengage PTO when moving.
6. Lift auger periodically to clear hole.
7. **DO NOT LET AUGER SCREW INTO GROUND. HOLD BACK WITH HYDRAULIC LIFT SO IT DIGS. DAMAGE TO DIGGER MAY OCCUR IF NOT PROPERLY OPERATED. DO NOT MOVE TRACTOR WITH AUGER IN GROUND.**

101015

! DANGER

KEEP CLEAR!
ENTANGLEMENT CAN CAUSE SERIOUS BODILY INJURY OR DEATH.



! OPERATOR MUST ALWAYS STAY ON TRACTOR SEAT.
! NEVER OPERATE IF ANYONE IS WITHIN TWENTY-FIVE (25) FEET OF AUGER.
! NEVER REPLACE SHEARBOLT OR AUGER ATTACHING BOLTS WITH LONGER BOLT.
! NEVER ATTEMPT TO HANG ON THE DIGGER TO FORCE IT INTO GROUND-SEVERE INJURY OR DEATH COULD OCCUR.

101032

! DANGER ! DANGER ! DANGER

Rotating Parts Hazard
Keep Away

To Prevent Serious Injury or Death from Rotating Parts:
Si no entiende ingles, se prefiere que busque a alguien que interprete las instrucciones para usted.

- Read and understand owner's manual before operating.
- Do not operate without all shields and guards in place.
- Do not use body weight to force the auger into the ground or to locate auger point when auger is turning.
- Keep away from auger, cutting head and driveline when engine is running.
- Never replace shearbolt or auger attaching bolts with longer bolt.



WS101130

LOCATED ON POST HOLE DIGGER BOOM

! DANGER

GUARD MISSING
 When this is visible
DO NOT OPERATE



KEEP CLEAR!
 Keep Others Away!
ENTANGLEMENT HAZARD
can cause Serious Injury or Death

Si no entiende ingles, se prefiere que busque a alguien que interprete las instrucciones para usted.

- Never manually position the auger or manually force the auger into ground.
- This machine is designed to be operated ONLY from the tractor seat.
- Keep everyone clear of all moving parts of the digger while in operation.

WS101131

LOCATED AT TOP OF AUGER CENTER TUBE

REMEMBER: If Safety Signs have been damaged, removed, become illegible or parts replaced without Signs, new Safety Signs must be applied. New Safety Signs are available from your authorized distributor or factory.

INSTRUCTIONS

TRACTOR REQUIREMENTS AND PREPARATION

The Model 720 3-pt. mounted post hole digger will fit most Category I, Category II and some larger Category 0 tractors equipped with a standard 3-pt. hitch.

NOTE: Low profile tractors generally can only use 30" long augers instead of standard 42" long augers. Some low profile Category 0 tractors should use the Model 300 Post Hole Digger.

NOTE: Some Category 0 tractors have very short lift arms or $\frac{5}{8}$ " diameter (Cat. 0) lift arm ball ends. These tractors are not usually suitable for post hole digging operation.

It is recommended that only tractors with wide front axles be used with this implement. Tricycle front wheel arrangements are inherently unstable and tractor roll-over accidents are more likely to occur.

Check the tractor's 3-pt. hydraulic lift system. It should operate up and down smoothly and have enough power to lift the dirt-loaded auger out of the hole. Refer to your tractor operator's manual or dealer for any adjustments necessary to put the 3-pt. hydraulic lift system in good working order.



- **Power unit must be equipped with ROPS or ROPS cab and seat belt. Keep seat belt securely fastened. Falling off power unit can result in death from being run over or crushed. Keep foldable ROPS systems in "locked up" position at all times.**
- **Be sure your tractor is in good condition. Read all the safety precautions and make sure all operators are familiar with the safety rules of operation.**

Check the shield over the PTO stub shaft. Make sure it is in good condition and bolted securely to the tractor. Purchase a new shield if old shield is damaged or missing.

Tractor must be equipped with stabilizer bars, adjustable sway chains, or sway blocks to keep the post hole digger from swinging side to side.

Smaller size tractors may need front counter weights to counter-balance the weight of the post hole digger and the weight of the dirt on the auger.

ASSEMBLY AND MOUNTING

Unpack all the bundles and lay out various parts. Start with the yoke (Ref. #2). Place the pull pins (Ref. #10) through the holes in the legs of the yoke and secure with nuts and lock washers.

NOTE: If your tractor lift arm spacing is 32", place the pull pins on the outside of the yoke legs as shown in the diagram. If your tractor lift arm spacing is 26" or less, then place the pull pins on the inner side of the yoke legs. The pins are Category I ($\frac{7}{8}$ " dia.). If your tractor is Category II, then lift arm bushings are required to properly fit the $1\frac{1}{8}$ " dia. Cat. II lift arm balls. (Bushings not supplied.) Place the lift arms of your tractor over the pull pins in the yoke and secure with linchpins (not supplied).

Pin end of digger boom (Ref. #1) to tractor topline bracket. Raise boom by hand – check that it doesn't hit any part of topline bracket (some tractors only). If problem exists, change hole location and re-check. **Failure to check can result in boom damage.** Cat. I tractors need bushing. Connect yoke to boom with pin (Ref. #12) and cotter pins.

NOTE: Always use adapter bushings when using Category I pins on a Category II hitch. Trying to use Cat. I pins in a Cat. II hitch without bushings will result in a very sloppy fit and the post hole digger will be unstable.

NOTE: When attaching the yoke to the boom, use the hole in the adjustment channel best suited for your tractor. If you don't know the best hole location, start with the middle hole.

It is recommended that the gearbox output guard, the gearbox input guard, and the PTO driveline be assembled on the gearbox before the gearbox is fastened to the boom.

Place the gearbox upside down on the floor. Install the formed metal gearbox output shield (Ref. #9) on the gearbox. A socket with a long extension makes this an easy installation.

Clean and check the input shaft of the gearbox. If any nicks or dents have occurred in shipping, lightly file to remove and make the shaft smooth.

Install the guard on the front input end of the gearbox using the four bolts in the gearbox.

Grease the input shaft of the gearbox before installing the PTO shaft. This reduces the chance of the PTO shaft yoke from galling to the input shaft if the shear pin should break.

Slip the two telescoping ends of the PTO shaft together. Spray WD-40 into the yoke and wipe. This should remove some of the paint and make it easier to slide the yoke onto the input shaft of the gearbox. Install the unsplined end on the gearbox input shaft and bolt it in place with the $\frac{3}{8}$ " shear bolt (Ref. #13) and secure with the lock washer and nut.

INSTRUCTIONS (continued)

Figure A

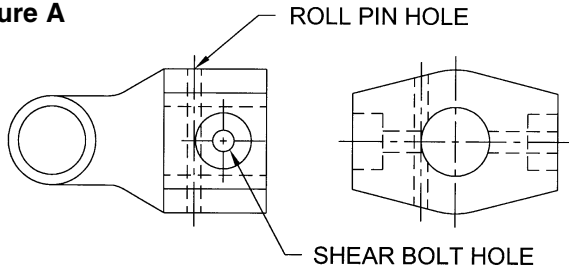

On the implement end of the PTO shaft there is a hole in the yoke just forward of the $\frac{3}{8}$ " shear bolt (see Figure A). This hole is for the $\frac{1}{4}$ " diameter x $2\frac{1}{4}$ " long roll pin (#2504042). When this roll pin is driven in this hole, the center of the roll pin engages into the groove on the front of the gearbox input shaft. This prevents the PTO assembly from coming off if the $\frac{3}{8}$ " shear bolt should shear. When replacing the shear bolt, use only a soft, Grade 2 shear bolt. **DO NOT** use a hard bolt!



WARNING!

Do not install a longer bolt or other longer fastener! A protruding fastener is more likely to grab loose clothing and can cause serious injury or death.

Attach the gearbox (Ref. #5) to the boom using the gearbox hitch pin (Ref. #6) and secure it with the two cotter pins (Ref. #7). The gearbox should be placed so that the large shaft is pointing toward the ground and the small shaft is pointing toward the tractor.

NOTE: The gearbox is shipped **WITHOUT** lubricant, so it will be necessary to fill it before use. With the gearbox in a level position, fill to the side inspection hole with a good 90 wt. gear lubricant. Check often and add lubricant if necessary.

Clean tractor PTO stub shaft and the inside of the splined driveline yoke. Pull the spring loaded solid metal ring from the end of the yoke and slip the splined driveline yoke on the splined PTO shaft of your tractor. Release the spring loaded ring and push the yoke on until it locks in place. (The spring loaded ring holds locking balls that lock the tractor end of the PTO driveline on the tractor PTO shaft.) Make certain the tractor PTO shield is in good condition and securely fastened onto the tractor.

Slowly raise and lower the digger **without** the auger on. Watch to see that the PTO driveline and/or shields do not separate or get into a bind. Check to see if gearbox end will lower to the ground. If it will not go all the way down, then either change the hole location between the yoke and boom or check to see if the PTO shaft is bottoming.

NOTE: If your tractor PTO shaft has a $1\frac{1}{8}$ " spline, it will be necessary to obtain a $1\frac{1}{8}$ " to $1\frac{3}{8}$ " sleeve spline adapter. If tractor is equipped with a $1\frac{1}{8}$ " to $1\frac{3}{8}$ " spline adapter extension, it may be necessary to cut the PTO shaft off in length. Check this before putting the auger on or digging a hole. To check, raise and lower the post hole digger with the tractor **BEFORE** putting the auger on.

NOTE: The use of a PTO extension could require that the PTO driveline be shortened a considerable amount. If this is done, the driveline halves may separate when the post hole digger is raised to transport position.

If the PTO driveline needs to be shorter, remove the driveline from the tractor and digger gearbox. Lower the digger (without the auger on) until the input shaft of the gearbox is in line with the PTO stub shaft of the tractor. (This should be the shortest distance required for the driveline.)

Pull the two telescoping halves of the PTO driveline apart. Connect the tractor end to the tractor and the gearbox end to the digger gearbox (but **NOT** with the two halves together).

Hold the two driveline sections parallel to each other and mark each end as to how much too long they are.

Then raise the digger to transport position and again hold the two driveline halves parallel to each other and check for a minimum of 6" (15 cm) overlap. If driveline has less than 6" overlap, do not use. Contact your dealer. If at least 6" of overlap is provided, then proceed in cutting the driveline.

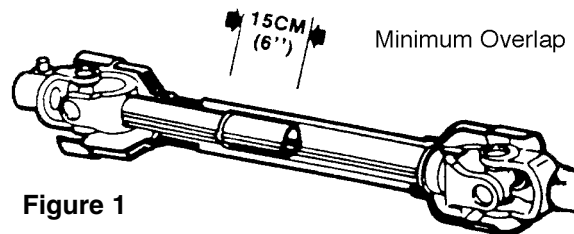

Figure 1

1. If driveline must be cut to a shorter length, clamp driveline in a well padded vise to prevent damage to the shield. Cut off shield where marked. Using cut-off section of shield as a guide, cut shaft the same amount. (Figure 2)

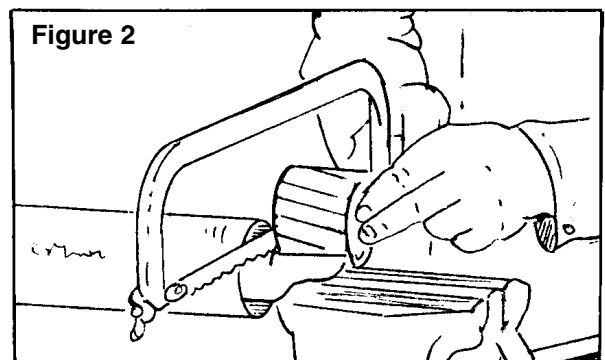

Figure 2

INSTRUCTIONS (continued)

2. Repeat the procedure to the other driveline half. Remove all burrs and cuttings.
 3. Apply multi-purpose grease to inside of outer (female) driveline section. Assemble driveline and install on tractor and digger. Pull on each driveline section to be sure yokes lock into place. Make certain driveline shielding is in place and in good condition.
 4. Carefully raise and lower the digger and check to be sure the PTO assembly does not jam. If it does, cut equal amounts from each half of the PTO assembly.
 5. Check the swinging drawbar of the tractor and make sure the PTO driveline assembly will not contact. The swinging drawbar can be moved forward on some tractors or it can be removed.
- Before beginning operation, clear area of objects that wrap around the auger or might be thrown. Contact local utility company to make certain there are no buried gas lines, electrical cables, etc., in the work area. Check for ditches, stumps, holes, or other obstacles that could cause the tractor to roll.
 - Layout and mark where you want to dig your holes.
 - ALL persons should be at least twenty-five (25') away. Clear the area of helpers, bystanders, especially children.
 - Do not allow anyone to stand behind, or to the side of a rotating auger.
 - To dig properly, your digger must be able to raise or lower through the highest and lowest points of your lift arm travel without binding against the tractor frame. Check carefully **BEFORE** attaching the auger. If it does bind, adjust the tractor 3 pt. linkage so that all movement is free.

WARNING!

When attaching PTO yoke to tractor PTO shaft, it is important that spring-activated locking pin or balls operate freely and are seated in groove on PTO shaft. A loose shaft could slip off and result in personal injury or damage to equipment.

NOTE: Use stabilizer bars, adjustable sway chains, or sway blocks on your tractor lift arms to keep the post hole digger from swinging side to side. Adjust as tightly as practical for best performance.

Slide the auger over the large shaft of the gearbox and secure it with the two bolts, lockwashers and nuts.

NOTE: Please refer to the drawings (Figures B through F, page 22) as to the proper mounting pattern for the cutting edges. Correct mounting of the cutting edges will assure a complete cut of earth by the auger.

PREPARATION PROCEDURE

- Thoroughly read and understand your Operator's Manuals.

On some tractors it may be necessary to remove the drawbar or slide it to one side. This will prevent the PTO driveline shaft from coming in contact with the drawbar. See your tractor's operator's manual for details.

CAUTION!

Operate the post hole digger only on a tractor with 540 RPM PTO shaft. The tractor's engine speed should not exceed 1200 RPM while digging.

If you have **ANY** questions, regarding the proper operation of this digger, contact your dealer or the manufacturer.

GEARBOX OIL FILL

NOTE: The gearbox is shipped WITHOUT lubricant, so it will be necessary to fill it before use. With the gearbox in a level position, fill to the side inspection hole with a good 90 wt. gear lubricant. Gearbox holds 86 fluid oz. Check often and add lubricant if necessary.

OPERATING INSTRUCTIONS

PRE-OPERATION CHECKLIST

(OWNER RESPONSIBILITY)

- _____ Review and follow safety rules and safety signs on pages 3 through 11.
- _____ Check that post hole digger is properly and securely attached to tractor.
- _____ Make sure driveline spring-activated locking pin or locking balls operate freely and are seated firmly in tractor PTO spline groove.
- _____ Lubricate all grease fitting locations. Make sure PTO shaft slip joint is lubricated.
- _____ Check to be sure gear lube runs out the small check plug on side of gearbox.
- _____ Check that all hardware is properly installed.
- _____ Check to ensure blades are sharp and secure and cutting edges are positioned correctly.
- _____ Check that all shields and guards are properly installed and in good condition.
- _____ Set tractor PTO gear select lever for 540 rpm operation.

OPERATION

This Post Hole Digger was designed for one-man operation from the tractor seat. **It is the responsibility of the operator to see that no one else is within twenty-five feet (25') of the digger when it is operating.**

- Set tractor brakes. Take tractor out of gear. Shift to “Park” (if applicable).
- Do not allow anyone to stand behind, or to the side of a rotating auger.
- Lower auger point slowly to the ground with the PTO disengaged.
- With the auger point lowered to the ground, set the engine speed to idle, then engage the PTO. Make sure the auger point is on the ground before engaging the PTO.
- Increase the speed as required so dirt is conveyed from the hole. Refer to Owner’s Manual for suggestions on PTO speed.
- Under no circumstances should the PTO be run in excess of 540 RPM.

- In some types of soil, it may be necessary to hold back against the auger screw suction by moving the hydraulic control lever to “HOLD” or “RAISE” position to keep the auger from screwing into the ground.
- **NEVER use body weight to help the auger penetrate the ground.** When the ground is too tough to penetrate with your cutting edges and point, sharpen or replace them and try again. These are replaceable parts and must be in good condition to penetrate. (Optional Hydraulic Downpressure Kit is available – order #706080.)
- If you have difficulty penetrating hard ground, refer to Owner’s Manual Troubleshooting section for suggestions.
- When the auger has been lowered about a foot or so into the ground, raise the auger almost out of the hole to clear the dirt, then drill deeper and raise the auger again. Repeat this procedure until the desired hole depth is reached.
- Do not shovel dirt away from a rotating auger as the shovel can be caught and thrown by the auger.
- Disengage the power-take-off when traveling between holes.

IT IS ESSENTIAL THAT EVERYONE INVOLVED IN THE ASSEMBLY, OPERATION, TRANSPORT, MAINTENANCE, AND STORAGE OF THIS EQUIPMENT BE AWARE, CONCERNED, PRUDENT, AND PROPERLY TRAINED IN SAFETY.

The post hole digger auger is free-swinging, and care should be taken while transporting the machine. **DO NOT** transport the post hole digger while the PTO is engaged as this could cause the universal joints of the PTO driveline into a sharp operating angle and cause failure of the driveline.

DIGGING A HOLE: Position the tractor so that the auger point is placed where the hole is to be. Lower the auger so that the point touches the ground. The point of the auger should be approximately 3” back of center of the gearbox. As the auger works into the ground, this slight angle will straighten, due to the pivoting action of the boom downward. If the auger has a side tilt, correct with the lift arm adjustment on the tractor hitch.

If the auger tilts too far forward or to the rear, it may be necessary to move the tractor slightly. Be careful not to bend the auger.

OPERATION INSTRUCTIONS (continued)

Engage the tractor PTO with the engine at idle (or below 1000 engine RPM). As the auger penetrates the ground, lower the unit slowly with the 3 pt. hydraulic system. **DO NOT LET THE AUGER SCREW ITSELF INTO THE GROUND!** Auger must dig with the dirt breaking up and being carried to the top by the auger flighting.

Once the hole is dug to the desired depth raise the auger while rotating to bring the dirt out of the hole. To get a clean hole, it is sometimes best to lower the auger into the hole with the auger turning and then, when at the bottom, stop the rotation and raise the auger while not turning. This brings the dirt up with little left in the hole.

For best results, allow the digger to dig about half the required depth, then lift it partially out of the hole to remove dirt and then re-enter hole and finish to the desired depth.



Do not shovel dirt away from a turning auger, as the shovel can be caught by the auger and thrown. Do not allow anyone to stand behind or to the side of an operating auger. ALL persons should be at least 25 feet away.



Never locate auger by putting hands on auger, gearbox, or boom when there is any sign of rotation on the driveline or auger or if the tractor is running.

A Grade 2 ($\frac{3}{8}$ " x $2\frac{1}{2}$ ") shear bolt is included with your post hole digger. If the shear bolt shears, replace only with a soft, Grade 2 shear bolt. **DO NOT USE A HARD SHEAR BOLT!** Use of a hard shear bolt could result in damage to the gearbox or other post hole digger parts and voids any warranty.

Do not run the digger while transporting, as damage to the PTO shaft could occur.

DO NOT LET THE DIGGER DIG SO DEEP THAT THE PTO SHAFT IS RUNNING IN THE DIRT.



Remain on the tractor seat while operating the post hole digger. Assisting the machine by hand can result in possible injury or death.

NOTE: Be sure auger is completely retracted from the hole before attempting to move the tractor.

Once the auger is digging a hole, the **tractor cannot be moved**. Make sure brake is set securely. If the tractor does move while the auger is in a hole, **damage to the gearbox or auger can result (not covered by warranty)**.

Cutting edges and center point are replaceable. They should be sharpened or replaced when worn. In hard digging conditions, a fishtail type center point is more aggressive and is recommended.

NOTE: Be careful when raising the auger as high as your tractor's 3 pt. hitch can go. This can put the PTO shaft universal joints at an extreme angle and cause damage to the PTO shaft! It is best to raise the auger just enough to clear the hole when the PTO is engaged.

It is recommended **NOT** to raise the auger while it is running more than six (6) inches above the ground.

NOTE: If you have a rocky or large root soil condition, it is recommended that an industrial duty auger be used.

If you encounter rocks or roots that catch the auger and cause shear bolts to break, then remove the auger from the hole and use a large, heavy pry bar to break up the obstructing rock. A large root may have to be chopped to remove.

NOTE: Please refer to the drawings (Figures B through F) as to the proper mounting pattern for the cutting edges. Correct mounting of the cutting edges will assure a complete cut of earth by the auger.

OPERATION INSTRUCTIONS (continued)

If auger becomes lodged below ground, **DO NOT** attempt to lift auger out of ground by hydraulic lift power alone. Turn tractor off and disconnect PTO driveline from the tractor. Reverse the rotation of the auger by several turns. This can be accomplished by using a large pipe wrench and screwing the auger backwards until it clears. Extreme rocking or lifting loads while trying to clear stuck augers can cause auger, gearbox, or boom failure.

CAUTION!

Do not attempt to free the auger while the PTO is connected. Disconnect the PTO driveline from the tractor before attempting to free the auger.

CAUTION!

Underground utilities – Contact appropriate agencies to determine if hazardous items are buried under the digging site **BEFORE DIGGING!** Be certain underground utilities have been called to locate underground electric, gas, telephone, and other lines. Check your telephone book for calling instructions. Be sure post hole digger operator is properly informed. **WHEN IN DOUBT, DO NOT DIG!**

NOTE: Never exceed the recommended auger capacity of the post hole digger. The Model 720 heavy duty digger is designed for use with augers up to 24-inch diameter. Use of an incorrect auger or auger extension can cause equipment damage, loss of operator control and personal injury.

Safety is a primary concern in the design and manufacture of our products. Unfortunately, our efforts to provide safe equipment can be wiped out by a single careless act of an operator.

It has been said, “The best safety device is an informed, careful operator.” We ask you to be that kind of an operator.

TRANSPORTING

Pay particular close attention to the Safety Messages regarding transport. Avoid unnecessary injuries and equipment damage by exercising cautious, conscientious travel procedures.

Attaching the implement to the tractor increases the overall length of the working unit. Allow additional clearance for the implement to swing when turning.

CAUTION!

When traveling on public roads, whether at night or during the day, use accessory light and devices for adequate warnings to operators of other vehicles. Comply with all federal, state and local laws.

DO NOT OPERATE PTO DURING TRANSPORT.

Raise the post hole digger as high as possible for transporting.

Select a safe ground travel speed when transporting from one area to another. When traveling on roadways, transport in such a way that faster moving vehicles may pass you safely.

When traveling over rough or hilly terrain or when making turns, slow down and use extra care.

Read all safety warnings in the front of the manual.

**OBEY SAFETY
RULES!!
ALWAYS BE
CAREFUL!!**

OWNER SERVICE

The information in this section is written for operators who possess basic mechanical skills. Should you need help, your dealer has trained service technicians available. For your protection, read and follow all safety information in this manual.

WARNING!

- ▲ Lower post hole digger to ground or block securely, turn tractor engine off, remove key and disconnect PTO driveline from tractor PTO before performing any service or maintenance.
- ▲ Before working underneath, raise 3 pt. hitch to desired position and block securely. Hydraulic system leakdown and failure of mechanical or hydraulic system can cause equipment to drop.
- ▲ Keep all persons away from operator control area while performing adjustments, service or maintenance.

ROUTINE MAINTENANCE

DAILY CHECKS:

1. Check that all bolts, nuts, and screws are tight. Checking the bolts and nuts on the cutting blades is particularly important in rocky soil.
2. Check daily the level of the gearbox oil and top up to the correct level. Check for gearbox oil leaks. It should be noted that no warranty claim can be submitted on a gearbox that has run dry. It is essential that the gearbox is kept correctly filled with gearbox oil.
3. Grease the PTO shaft daily.
4. Check the wear on the cutting blades. Sharpen them routinely with an angle grinder or replace when worn down too far. Keep at least two sets of cutting blades, bolts, and nuts as spares.

LUBRICATION INFORMATION

The accompanying chart gives the frequency of lubrication in operating hours, based on normal conditions. Severe or unusual conditions may require more frequent lubrication.

Do not let excess grease collect on or around parts, particularly when operating in sandy areas.

Use an SAE 90W gear lube in gearbox.

Use a lithium grease of NO. 2 consistency with a MOLY (molybdenum disulfide) additive for all locations. Be sure to clean fittings thoroughly before attaching grease gun. When applied according to the lubrication chart, one good pump of most guns is sufficient. Do not over grease.

LUBRICATION CHART

REF NO.	DESCRIPTION	FREQUENCY
1	Front U-Joint	8 Hrs.
2	Rear U-Joint	8 Hrs.
3	Gearbox – Fill to proper level (Gearbox holds 56 fluid oz.)	Check Daily

Daily lubrication of the PTO slip joint is necessary. Failure to maintain proper lubrication can result in damage to U-joints, gearbox, tractor PTO and/or driveline.

AT THE END OF THE SEASON:

1. Drain and change the oil in your gearbox.
2. Check and replace, where necessary, blades, bolts, nuts on the machine.
3. Clean machine and touch up any rust spots that may have appeared.
4. Replace any safety signs if damaged or painted over.
5. Make sure PTO driveline yoke and gearbox input shaft are clean and free of burrs. Keep well lubricated to prevent galling of yoke and input shaft when shear bolt becomes sheared.
6. Keep all shields in place. Order new shields if damaged or missing.
7. Keep cutting edges sharp. Sharp cutting edges dig easier and better. Outer cutting edges on larger augers wear faster than inner cutting edges; switching teeth will even wear.
8. Store implement in clean, dry location, away from children, animals, or traffic area.

REMOVING DIGGER FROM TRACTOR

Post hole diggers when off the tractor, can be an awkward piece of equipment to handle. Be careful not to pinch hands and fingers in the various hinge points of the digger.

A parking stand can make handling a post hole digger easier.

OPTIONAL PARKING STAND

The parking stand kit has two removable legs that go into sockets on a plate bolted to the gearbox.

The two legs and the auger form a tripod which will support the post hole digger when removed from the tractor.

Order optional parking stand #102165.

TROUBLE-SHOOTING GUIDE

PROBLEM: AUGER WILL NOT DIG

Possible Solutions:

- Shear bolt sheared – install new shearbolt.
- Teeth dull – sharpen or replace.
- Ground too dry and hard – order optional down force kit, or wait until it rains. (May have to replace center point.)
- Auger turning too fast and bouncing – reduce speed.
- Tall grass has wrapped around auger teeth – remove.
- Auger encountering rocks, roots, or other obstruction – lift auger from hole and inspect.
- Auger teeth improperly positioned – see operator's manual for proper tooth pattern.

PROBLEM: AUGER DIGS SO FAR, BUT WILL NOT DIG DEEPER

Possible Solutions:

- See solutions for above.
- PTO assembly “bottoms out,” not allowing digger to lower – remove auger from digger and lower digger. Gearbox should lower to the ground; if not, PTO driveline assembly may need to be shortened.
- PTO driveline interferes with swinging drawbar – swing drawbar out of the way or remove.
- Tractor hydraulic system may be faulty – consult tractor dealer.
- Soil could have hardpan layer 6”-10” below surface – use optional down force kit (see list of optional equipment).

PROBLEM: POST HOLE DIGGER SWAYS SIDE TO SIDE

Possible Solutions:

- No sway bars or sway blocks on tractor – add same.
- Lift arms not adjusted evenly – adjust lift arms.
- Post hole digger is mounted with excessive looseness in the hitch connecting points – use proper size pins or bushings.

PROBLEM: BENT AUGER FLIGHTING OR BENT AUGER

Possible Solutions:

- Tractor moved while auger was turning in hole – always set brakes on tractor and make sure it is out of gear.
- Operator moved tractor with auger in hole to try and straighten a hole being dug at an angle.
- Auger is encountering rocks or roots or other foreign objects – remove object from hole or change location.
- Outer edge of auger flighting is bending due to contact with rocks or roots – use industrial duty auger with thicker flighting.
- Shear bolt has been replaced with harder bolt – replace with Grade 2 bolt per instructions.

PROBLEM: AUGER SCREWS ITSELF INTO THE GROUND

Possible Solutions:

- Operator did **NOT** ease 3-pt. hitch to ground slowly.
- Faulty 3-pt. hitch hydraulic system on tractor.
- Draft control is not in **OFF** position.
- Tractor is too small to handle digger.

PROBLEM: EXCESSIVE VIBRATION

Possible Solutions:

- PTO driveline bearing cross is worn – replace.

PROBLEM: PTO DRIVELINE ASSEMBLY COMES OFF INPUT SHAFT OF GEARBOX WHEN SHEAR BOLT IS SHEARED.

Possible Solution:

- Roll pin missing in yoke at gearbox input shaft. Install roll pin as per instructions.



**THIS IS A DANGEROUS SAFETY HAZARD,
CORRECT IMMEDIATELY!**

TROUBLE-SHOOTING GUIDE (continued)

PROBLEM: PTO DRIVELINE FAILURE

Possible Solutions:

- Operator raising post hole digger too high above ground when PTO is engaged – causes excessive PTO joint operating angle.
- PTO is engaged while moving between holes. (Auger swings, which causes excessive PTO joint operating angle.)
- Improper use of a hard shearbolt – use Grade 2 bolt per instructions.
- Driveline has not been properly lubricated.
- Engaging tractor PTO with engine at high rpm.
- Digging holes too deep so that PTO driveline contacts ground.
- Operating at high rpm.
- Use of auger extension can require post hole digger to be lifted high, which can cause excessive PTO joint operating angle.
- Tractor is a “low profile model” (one that is low to the ground). Due to the low height of the tractor, the digger must be raised higher to have the bottom of the auger clear the ground. Generally, low profile model tractors can only use 30 inch long augers (standard auger length is 42”). Use a different tractor or purchase 30” long augers.

PROBLEM: TRACTOR STALLS

Possible Solutions:

- Auger is encountering rocks or roots or other foreign object – remove object or change hole location.
- Tractor idle is not set correctly – tune tractor engine.

PROBLEM: GEARBOX FAILURE

Possible Solutions:

- No oil in gearbox.
- Oil not changed per instructions.
- Shear bolt has been replaced with a harder bolt – replace with Grade 2 per instructions.
- Bent output shaft is due to operator moving tractor when auger is in hole.

PROBLEM: GEARBOX OVERHEATING

Possible Solutions:

- Low on lubricant – fill to proper level.
- Improper type lubricant – replace with proper lubricant.

PROBLEM: AUGER BOLTS SHEAR ON GEARBOX OUTPUT SHAFT

Possible Solutions:

- Shearbolt on input shaft has been replaced with a harder bolt – replace with Grade 2 bolt as per instructions.

PROBLEM: PTO DRIVELINE “GALLS” OR “FRICTION WELDS” TO INPUT SHAFT OF GEARBOX

Possible Solution:

- No lubrication on input shaft of gearbox to allow yoke of PTO driveline to turn freely on input shaft when shear bolt is sheared. Always keep input shaft greased.
- Implement end yoke and gearbox input pinion may have to be replaced.

POST HOLE DIGGER OPTIONS

1. **Industrial Duty Augers:** Augers with heavier flighting and a reinforced drive tube are available for rocky or tough soil conditions. Check with dealer for availability.
2. **12” Auger Extension:** Available for situations where deeper holes are required. **NOTE:** Smaller tractors may not raise auger high enough to clear hole when 12” auger extension is used. Order part #170705.
3. **Hydraulic Down Force Kit:** For tough, hard soil conditions. This will allow operator to put 300-400 lbs. of down force on the auger to force cutting edges into tough or hard ground. Tractor must have auxiliary hydraulic outlet. Order part #706080 for Model 720 Post Hole Diggers.
4. **Parking Stand Kit:** This kit allows the post hole digger to be stored in an upright position. Makes connecting and disconnecting from tractor an easy one man operation. Order part #102165.

MODEL 720 POST HOLE DIGGER REPAIR PARTS

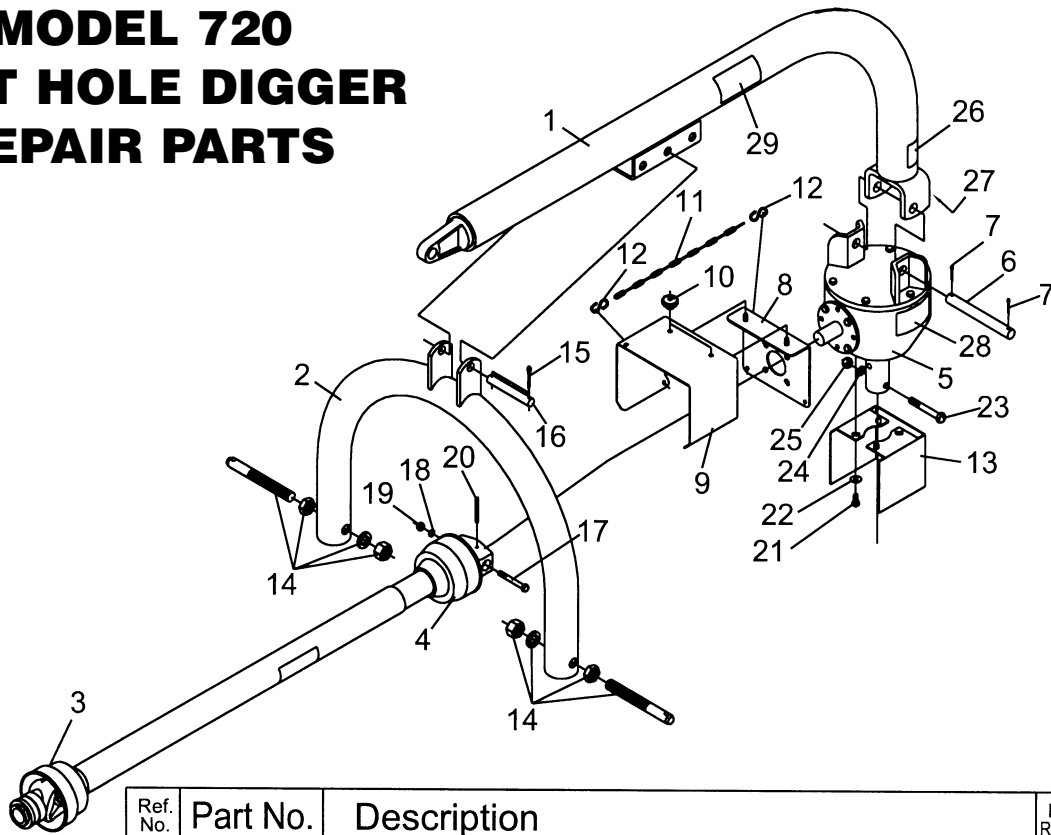

Ref. No.	Part No.	Description	No. Req'd.
1	705001	Boom Weldment	1
2	3814007	Yoke Weldment	1
	706420	PTO Shaft Complete	1
3	706424	1/2 PTO (Tractor End)	1
4	706425	1/2 PTO (Implement End)	1
5	706405	Gearbox	1
6	706419	Gearbox Pin	1
7	702153	Cotter Pin 5 x 40	2
8	706437	Input Guard Back Weldment	1
9	706435	Input Guard	1
10	2504220	Knob, Threaded	2
11	706438	Chain, Safety	1
12	2504016	S-Hook	2
13	170916	Shield, Output	1
14	590071	Lift Pin w/Hardware (AK-479)	2
15	2504121	Cotter Pin 3/16" x 1 1/2"	2
16	3814019	Boom Adjustment Pin	1
17	2503209	Bolt 3/8"-16NC x 3" Hex Head Gr.2	1
18	2502008	Washer 3/8" Springlock	1
19	2500004	Nut 3/8"-16NC Full Hex	1
20	2504042	Roll Pin 1/4" x 2 1/4"	1
21	2503030	Bolt 3/8"-16NC x 3/4" Hex Head Gr.2	4
22	2501004	Washer 3/8" Flat	4
23	2503109	Bolt 1/2"-13NC x 3 1/2" Hex Head Gr.2	2
24	2502002	Washer 1/2" Springlock	2
25	2500003	Nut 1/2"-13NC Full Hex	2
26	101130	Safety Sign - Danger (Rotating Parts)	1
27	101015	Safety Sign - PHD Instructions	1
28	101188	Sign - Gearbox Notice	1
29	101032	Safety Sign - Danger (Entanglement)	1

AUGER TEETH MOUNTING PATTERNS



FIG.
B
6"

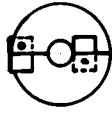

FIG.
C
9"

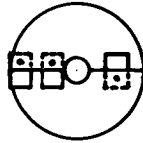

FIG.
D
12" & 14"

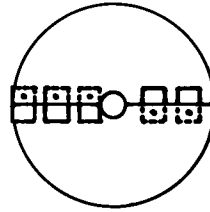

FIG.
E
18"

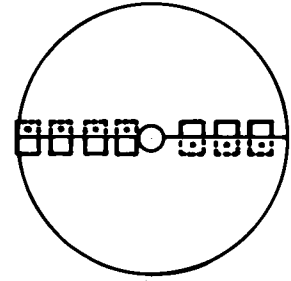
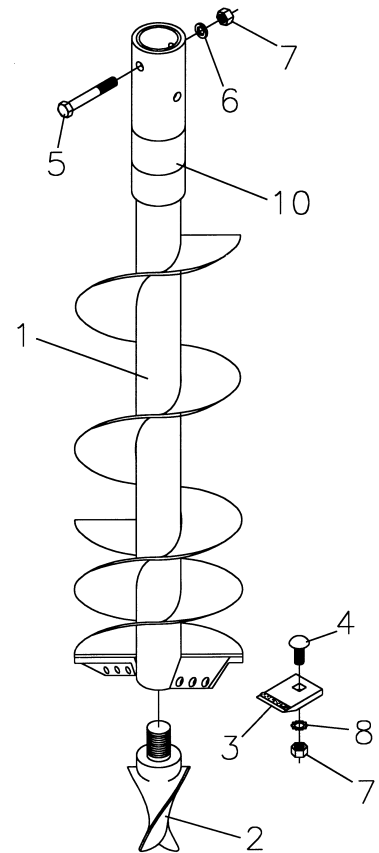

FIG.
F
24"

HEAVY DUTY AUGER REPAIR PARTS (WITH THREADED CENTER POINT)

Ref. No.	Part No.	Description	No. Req'd.
1	706150	6" HD Single Flight Auger (Complete)	Opt.
	706155	6" HD Double Flight Auger "	Opt.
	706109	9" HD Single Flight Auger "	Opt.
	706009	9" HD Double Flight Auger "	Opt.
	706112	12" HD Single Flight Auger "	Opt.
	706012	12" HD Double Flight Auger "	Opt.
	706033	14" HD Single Flight Auger "	Opt.
	706037	14" HD Double Flight Auger "	Opt.
	706070	18" HD Double Flight Auger "	Opt.
	706075	24" HD Double Flight Auger "	Opt.
2	170802	Fishtail Auger Point	1
3	706021	Red Claw Digger Tooth	Var.
4	2503166	Bolt 1/2"-13NC x 1 1/4" Carriage Head	Var.
5	2503109	Bolt 1/2"-13NC x 3 1/2" Hex Head	2
6	2502002	Washer 1/2" Springlock	2
7	2500003	Nut 1/2" Full Hex	Var.
8	2502003	1/2" External Star Lockwasher	Var.
N/S	2503178*	Bolt 3/8"-16NC x 1 1/4" Carriage Head (6" only)	2
N/S	2502014*	3/8" External Star Washer (6" only)	2
N/S	2500004*	Nut 3/8" Full Hex (6" only)	2
10	101131	Safety Sign - Danger (Guard Missing)	1



HEAVY DUTY AUGER REPAIR PARTS

(WITH BOLT-IN CENTER POINT)

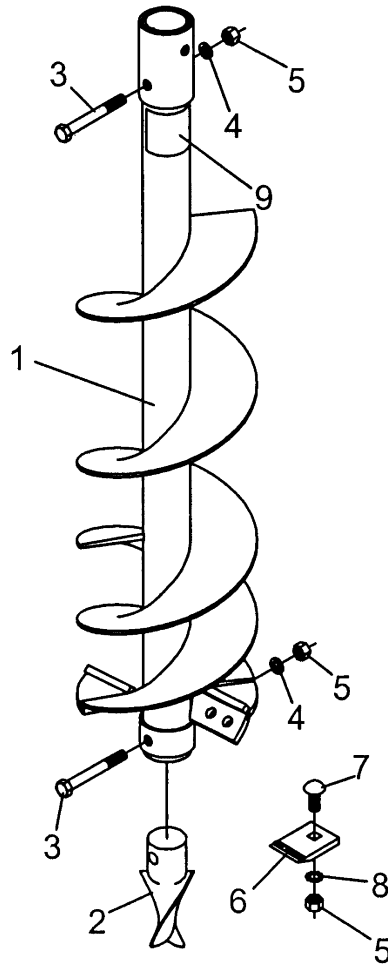

NOTE:
Auger Tooth Mounting
Pattern same as shown
on page 22.

Ref. No.	Part No.	Description	No. Req'd.
1	706150	6" HD Single Flight Auger (Complete)	Opt.
	706155	6" HD Double Flight Auger "	Opt.
	706109	9" HD Single Flight Auger "	Opt.
	706009	9" HD Double Flight Auger "	Opt.
	706112	12" HD Single Flight Auger "	Opt.
	706012	12" HD Double Flight Auger "	Opt.
	706033	14" HD Single Flight Auger "	Opt.
	706037	14" HD Double Flight Auger "	Opt.
	706070	18" HD Double Flight Auger "	Opt.
	706075	24" HD Double Flight Auger "	Opt.
2	170430	Fishtail Auger Point (Bolt-In)	1
3	2503109	Bolt 1/2"-13NC x 3 1/2" Hex Head	2
4	2502002	Washer 1/2" Springlock	2
5	2500003	Nut 1/2" Full Hex	Var.
6	706021	Red Claw Digger Tooth	Var.
7	2503166	Bolt 1/2"-13NC x 1 1/4" Carriage Head	Var.
8	2502003	1/2" External Star Lockwasher	Var.
9	101131	Safety Sign - Danger (Guard Missing)	1

GEARBOX REPAIR PARTS

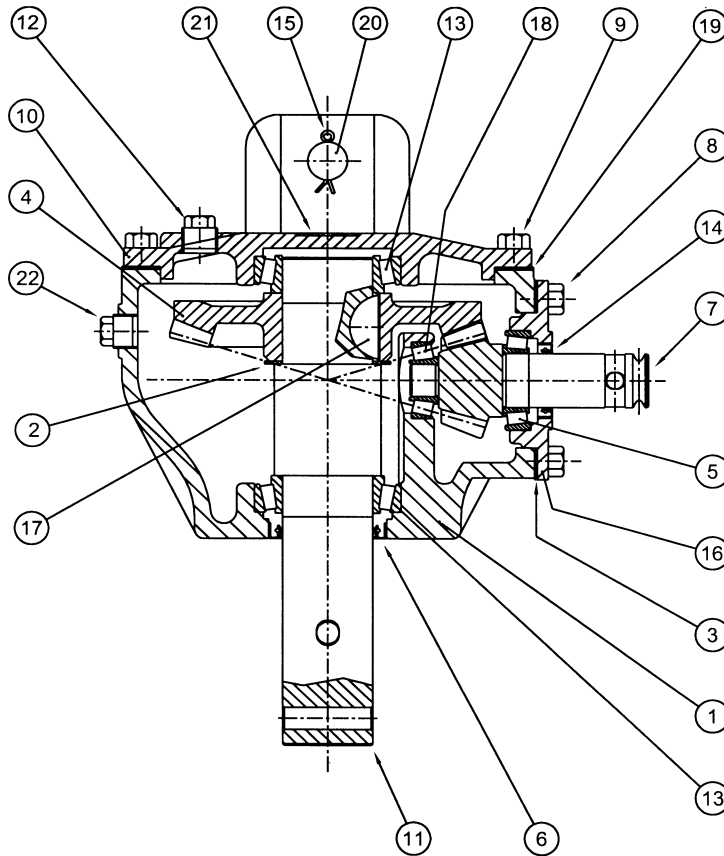

Ref. No.	Worksaver Part No.	Comer Part No.	Description	No. Req'd.
	706405	9.196.000.00	Complete Gearbox	1
1	Not Available	0.196.0300.00	Casting & Machining	1
2	Not Available	0.196.7500.00	Shim Kit (51.1 x 63)	1
3	706407	0.196.7300.00	Gasket Kit (81.5 x 118)	1
4	Not Available	0.196.6000.00	Crown Gear Z35 M5.08	1
5	706409	8.0.9.02531	Roller Bearing LM67048 - LM67010	1
6	706410	8.7.1.02529	Dust Lip 50.8 x 66.62 x 7.92	1
7	706411	0.196.5000.00	Pinion Z11 M5.08	1
8	702152	8.1.1.00061	Bolt M10 x 25 (8.8)	4
9	702149	8.1.1.00073	Bolt M10 x 30 (8.8)	6
10	Not Available	0.196.1300.00	Top Plate	1
11	Not Available	0.196.3001.00	Output Shaft	1
12	702147	8.6.5.00203	1/2" Gas Solid Plug	1
13	706413	8.0.9.02532	Roller Bearing LM104949 - LM104911	2
14	706414	8.7.1.02530	Dust Lip 31.75 x 44.5 x 7.92	1
15	702153	8.4.7.00671	Cotter Pin 5 x 40	2
16	Not Available	0.196.1301.00	Cover	1
17	706416	0.196.7000.00	Woodruff Key 7.94 x 16.28	1
18	706417	8.0.9.02533	Roller Bearing LM11910 - LM11949	1
19	706418	0.196.7200.00	Gasket Kit (190 x 224.5)	1
20	706419	0.196.3000.00	Pivot Shaft	1
21	Not Available	U0.100.7000.00	Name Plate	1
22	702146	8.6.5.00006	3/8" Gas Solid Plug	1

MODEL 720 POST HOLE DIGGER PTO SHAFT (Shear Bolt Protected) REPAIR PARTS

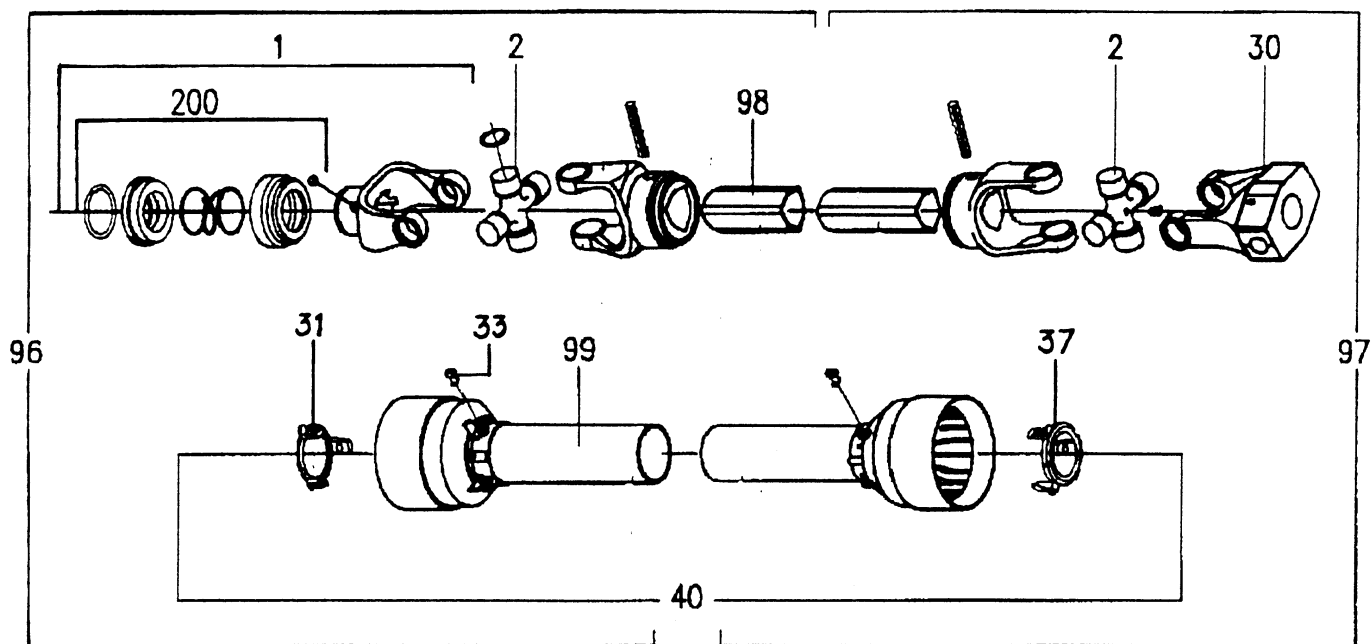

Ref. No.	Worksaver Part No.	Description	Com. Code No.	No. Req'd.
	706420	PTO Shaft Complete (Metric Series 4)	807.422.195.11	1
1	706421	Complete Collar Yoke (Tractor End)	141.024.430.1	1
2	650769	Cross Journal Set (Metric Series 4)	180.014.130	2
30	706422	Special Yoke (Implement End)	141.024.539.1	1
31	650771	Guard Retaining Collar for Outer Tube	180.013.012	1
33	650712	Bolt, Plastic	190.000.019	6
37	650772	Guard Retaining Collar for Inner Tube	180.013.011	1
40	706423	Complete Guard w/Instruction Manual	8142.240.413.7421	1
96	706424	1/2 PTO (Tractor End)	8123.340.259.11	1
97	706425	1/2 PTO (Implement End)	8123.440.552.11	1
98	650726	"DANGER" Label for Outer Tube	190.000.098	1
99	650727	"DANGER" Label for Outer Guard Tube	190.000.099	1
200	170982	Slide Collar Kit 1 3/8"	165.000.628	1

*Note: This PTO Driveline is used with S/N 030500001 and above.

NOTE: This PTO driveline is a Metric Series 4, black plastic guards and oblong shaped implement end yoke with recessed holes for shearbolt.

OPTIONAL DFK-70 DOWN FORCE KIT REPAIR PARTS

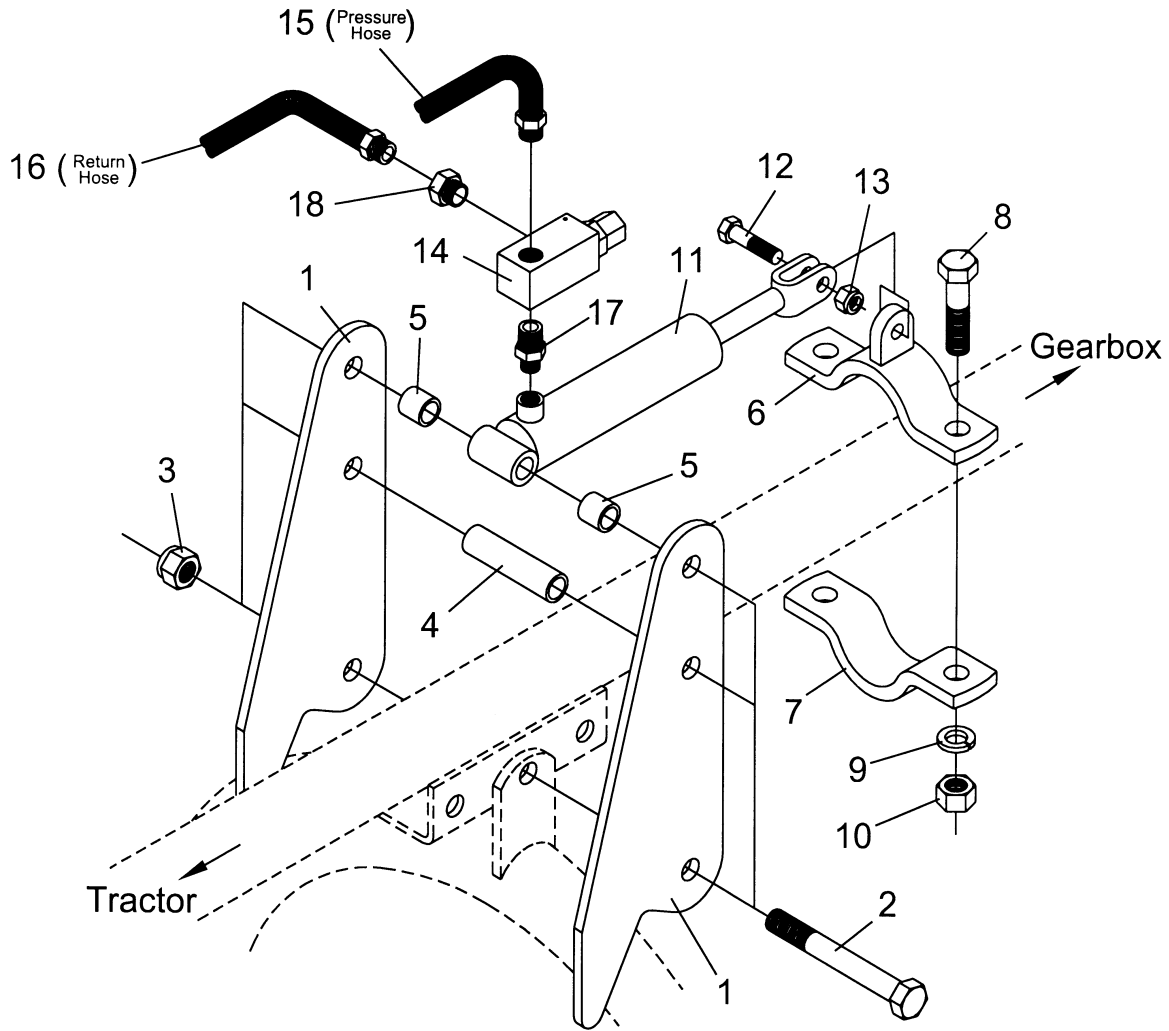

Ref. No.	Part No.	Description	No. Req'd.
1	706081	Pivot Plate	2
2	2503035	Bolt 3/4"-10NC x 6" Hex Head Gr.5	3
3	2500037	Nut 3/4"-10NC Hex Nylock	3
4	706082	Long Spacer 3 7/8"	1
5	706083	Short Spacer 15/16"	2
6	706084	Upper Clamp Weldment	1
7	706085	Lower Clamp Half	1
8	2503135	Bolt 3/4"-10NC x 3" Hex Head Gr.5	2
9	2502001	Washer 3/4" Springlock	2
10	2500002	Nut 3/4"-10NC Full Hex	2
11	862817	Hydraulic Cylinder 1 1/2 x 6	1
12	2503007	Bolt 1/2"-13NC x 2" Hex Head Gr.2	1
13	2500039	Nut 1/2"-13NC Hex Nylock	1
14	2505501	Relief Valve	1
15	2504102	Hydraulic Hose 3/8" x 60"	1
16	2505001	Hydraulic Hose 3/8" x 72"	1
17	2505502	Adapter Fitting 3/8" to 1/2"	1
18	2505608	Reducer Fitting 1/2" to 3/8"	1

DOWN FORCE KIT INSTRUCTIONS

KIT #706080 DFK-70
(FOR MODEL 720 POST HOLE DIGGER)

INSTALLATION

1. Refer to the parts illustration and install the Down Force Kit parts as shown. The pin attaching the boom to the yoke is replaced by a $\frac{3}{4}$ - 10 NC x 6" lg. hex head bolt and lock nut.
2. Use a good grade hydraulic thread sealant and install the hydraulic components. Do not use Teflon tape!
3. Install the hydraulic cylinder and boom clamp. The cylinder rod should be retracted and the boom clamp installed loosely so that it can slip on the boom. Raise the Post Hole Digger to its full up position. Now tighten the boom clamp bolts to 300 ft. lbs. torque. It may be necessary to retighten the clamp bolts after initial use to keep the clamp from slipping.
4. Connect the pressure hose (item #15) to one of the tractor remote outlets.
5. Connect the return hose (item # 16) directly to the tractor hydraulic reservoir fill opening. **NOTE: DO NOT CONNECT THE RETURN HOSE TO A REMOTE OUTLET.** The remote outlet valve ports are blocked in the neutral position and will damage the hydraulic cylinder or other parts when the boom is raised.

OPERATION

Lower the Post Hole Digger in the usual manner and allow the auger to dig. As down force is needed, apply it carefully and in small amounts by using the control lever on the tractor remote outlet. It will be necessary to continue lowering the lift arms as the auger digs. Applying too much down force at one time can stall the auger and possibly cause the shear bolt on the post hole digger input shaft to shear. **NOTE: REPLACE THE SHEAR BOLT WITH A GRADE #2 (SOFT) BOLT ONLY.** Using a (HARD) bolt can damage the auger, PTO driveline or gearbox and void the warranty.

The boom can be raised in the normal manner without relieving the down force cylinder pressure.

NOTE: DAMAGE CAN OCCUR IF HOSES ARE NOT CONNECTED CORRECTLY. If the return hydraulic hose is connected to the other tractor remote outlet instead of directly to the tractor hydraulic reservoir, severe damage will possibly occur to the hydraulic cylinder and post hole digger when the boom is raised. Make sure hydraulic hoses are connected correctly.



**SAFETY ...
YOU CAN LIVE
WITH IT!**

**OBEY SAFETY
RULES!!
ALWAYS BE
CAREFUL!!**

⚠ SAFETY PRECAUTIONS ⚠

**MOST ACCIDENTS OCCUR BECAUSE OF NEGLIGENCE OR CARELESSNESS.
AVOID NEEDLESS ACCIDENTS BY FOLLOWING ALL OF THE SAFETY PRECAUTIONS LISTED BELOW.**

- Machinery should be operated only by those who are responsible and are authorized to do so.
- Stop the engine, lower all equipment, lock the brakes, and remove the ignition key before dismounting from the tractor.
- Never stand between tractor and implement while tractor is being backed to hitch.
- Loose fitting clothing should not be worn, to avoid catching on various parts.
- Detach implement in area where children normally do not play.
- When performing adjustments or maintenance on an implement, first lower it to the ground or block it securely at a workable height.
- Only a qualified operator should be permitted on tractor when in operation; no riders allowed.
- Make certain everyone is in the clear before starting tractor or raising or lowering equipment.
- Operate the tractor and implement only while seated in the driver's seat.
- Reduce speed when transporting mounted implements to avoid bouncing and momentary loss of steering control.
- A heavy load can cause instability of the tractor. Use extreme care during road travel. Slow down on turns and watch out for bumps. Tractor may need front counterweights to counter-balance the weight of the implement.
- Reduce speed on hillsides or curves so there is no danger of tipping.
- Avoid driving too close to the edge of ditches or creeks.
- Do not transport implement on public roads without reflectors and slow moving vehicle emblem in daylight and with approved warning lights at night and other periods of poor visibility.
- Due to the width of some implements, use extra caution on highways, farm roads, and when approaching gates.
- Always be sure the implement is in the proper position for transport.
- Keep alert and watch the front as well as the rear when working with the implement.

OWNER'S/ OPERATOR'S MANUAL

**MODEL NO.
720**

**SINO LEEINGLES, PIDA AYUDA
A AIGUIEN QUE SI LO LEA
PARA QUE LE TRADUZCA LAS
MEDIDAS DE SEGURIDAD.**

JANUARY 2010

HEAVY DUTY 3-PT. MOUNTED POST HOLE DIGGER

**WHEN ORDERING REPAIR PARTS,
ALWAYS GIVE THE FOLLOWING INFORMATION:**

1. PART NUMBER
2. PART DESCRIPTION
3. MODEL NUMBER
4. NAME OF ITEM

**MAKE EVERY DAY
A HOLIDAY
FROM ACCIDENTS!**

WORKSAVER, INC.

P.O. BOX 100 LITCHFIELD, IL 62056-0100 (217) 324-5973
WEB: <http://www.worksaver.com> E-MAIL: sales@worksaver.com