

# OWNER'S MANUAL

**MODEL NO.**  
RB-880

## **CAUTION**

For Safe Operation  
Read Rules And  
Instructions Carefully

**SINO LEEINGLES, PIDA AYUDA  
A AIGUIEN QUE SI LO LEA  
PARA QUE LE TRADUZCA LAS  
MEDIDAS DE SEGURIDAD.**

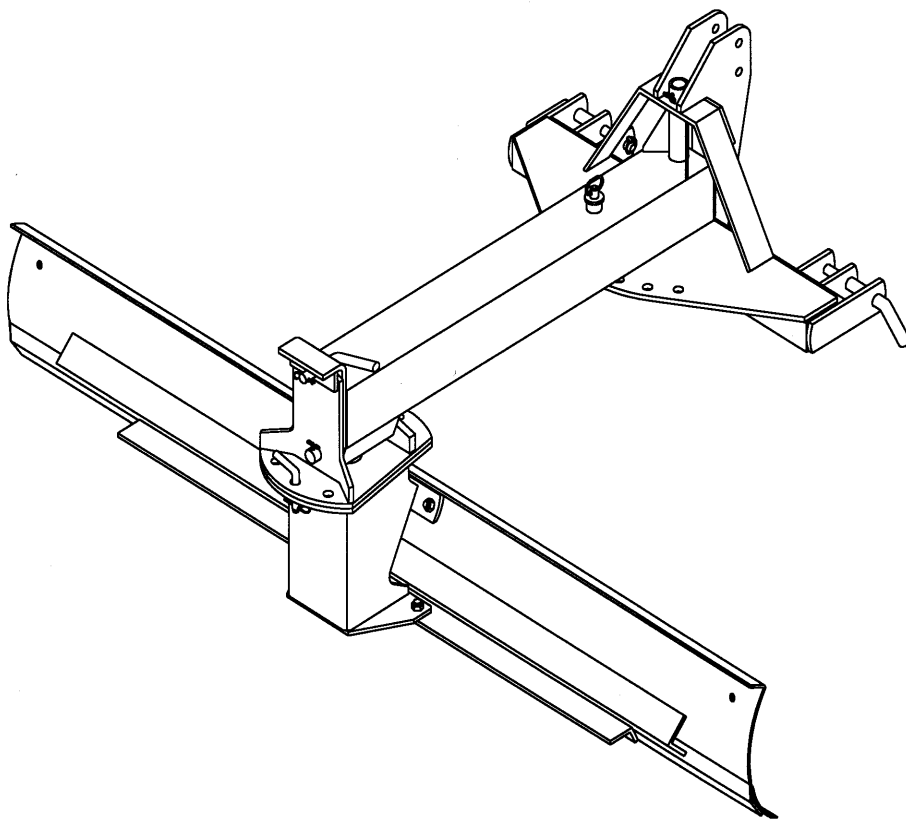

## 3 PT. REAR BLADE

For Cat. I and II  
3 Pt. Hitch Tractors

**Safety Instructions**  
**Tractor Preparation**  
**Operating Instructions**

**Assembly & Mounting**  
**Maintenance**  
**Repair Parts**

### STATEMENT OF POLICY

It is the policy of **Worksaver, Inc.** to improve its products where it is possible and practical to do so. **Worksaver, Inc.** reserves the right to make changes or improvements in design and construction at any time, without incurring the obligation to make these changes on previously manufactured units.

## **CAUTION**

**THE FOLLOWING SAFETY PRECAUTIONS SHOULD BE THOROUGHLY UNDERSTOOD  
BEFORE ATTEMPTING TO BEGIN ASSEMBLING THIS MACHINE**

1. Select an area for assembly that is clean and free of any debris which might cause persons working on the assembly to trip.
2. Do not lift heavy parts or assemblies. Use crane, jack, tackle, fork trucks or other mechanical devices.
3. Preview the assembly instructions in your operator's manual before proceeding further.
4. If the assembly instructions call for parts or assemblies to be blocked up, use only blocking material that is in good condition and is capable of handling the weight of the assembly to be blocked. Also insure that the blocking material is on a clean, dry surface.
5. Never put hands, or any part of body, under blocked up assemblies if at all possible.
6. After completing assembly, thoroughly inspect the machine to be sure that all nuts, bolts, hydraulic fittings or any other fastened assemblies have been thoroughly tightened.
7. Before operating the machine, thoroughly read the operation section of your operator's manual.
8. Before operating, read the maintenance section of your operator's manual to be sure that any parts requiring lubrication, such as gearboxes, are full, to avoid any possible damage.
9. **Before operating equipment – If you have any questions regarding the proper assembly or operation, contact your Worksaver dealer or representative.**

# TABLE OF CONTENTS

SAFETY INFORMATION .....	2
SAFETY SIGNS .....	11
PREPARATION INSTRUCTIONS .....	13
OPERATING INSTRUCTIONS .....	15
OWNER MAINTENANCE & LUBRICATION .....	17
TROUBLESHOOTING .....	18
PARTS LISTS .....	19
WARRANTY .....	22

SINO LEEINGLES, PIDA AYUDA A AIGUIEN QUE SI LO LEA PARA QUE LE TRADUZCA LAS MEDIDAS DE SEGURIDAD.

## STATEMENT OF POLICY

It is the policy of **Worksaver, Inc.** to improve its products where it is possible and practical to do so. **Worksaver, Inc.** reserves the right to make changes or improvements in design and construction at any time, without incurring the obligation to make these changes on previously manufactured units.

## TO THE OWNER :

Read this manual before using your 3 Pt. Rear Mounted Blade. This manual is provided to give you the necessary operating and maintenance instructions for keeping your rear blade in top operating condition. Please read this manual thoroughly. Understand what each control is for and how to use it. Observe all safety signs on the machine and noted throughout the manual for safe operation of implement. Keep this manual handy for ready reference.

Like all mechanical products, it will require cleaning and upkeep. Lubricate the blade as specified.

Use only genuine Worksaver, Inc. service parts. Substitute parts will void the warranty and may not meet standards required for safe and satisfactory operation. Record the model and serial number of your blade here:

Model: \_\_\_\_\_ Serial Number: \_\_\_\_\_

---

---

## RETAIL CUSTOMER'S RESPONSIBILITY

**It is the Retail Customer and/or Operator's responsibility to read the Operator's Manual, to operate, lubricate, maintain, and store the product in accordance with all instructions and safety procedures. Failure of the operator to read the Operator's Manual is a misuse of this equipment.**

**It is the Retail Customer and/or Operator's responsibility to inspect the product and to have any part(s) repaired or replaced when continued operation would cause damage or excessive wear to other parts or cause a safety hazard.**

**It is the Retail Customer's responsibility to deliver the product to the authorized Worksaver Dealer, from whom he purchased it, for service or replacement of defective parts which are covered by warranty. Repairs to be submitted for warranty consideration must be made within forty-five (45) days of failure.**

**It is the Retail Customer's responsibility for any cost incurred by the Dealer for traveling to or hauling of the product for the purpose of performing a warranty obligation or inspection.**

# To the Owner/Operator/Dealer

All implements with moving parts are potentially hazardous. There is no substitute for a cautious, safe-minded operator who recognizes the potential hazards and follows reasonable safety practices. The manufacturer has designed this implement to be used with all its safety equipment properly attached to minimize the chance of accidents.

## BEFORE YOU START!!

**Read the safety messages on the implement and shown in your manual.  
Observe the rules of safety and common sense!**



### THIS SYMBOL MEANS

- ATTENTION!
- BECOME ALERT!
- YOUR SAFETY IS INVOLVED!

THIS SAFETY ALERT SYMBOL IDENTIFIES IMPORTANT SAFETY WARNING MESSAGES. CAREFULLY READ EACH WARNING MESSAGE THAT FOLLOWS. FAILURE TO UNDERSTAND AND OBEY A SAFETY WARNING, OR RECOGNIZE A SAFETY HAZARD, COULD RESULT IN AN INJURY OR DEATH TO YOU OR OTHERS AROUND YOU. THE OPERATOR IS ULTIMATELY RESPONSIBLE FOR THE SAFETY OF HIMSELF, AS WELL AS OTHERS, IN THE OPERATING AREA OF THE TRACTOR AND ATTACHED EQUIPMENT.

---

## UNDERSTAND SIGNAL WORDS

Note the use of the signal words **DANGER**, **WARNING** and **CAUTION** with the safety messages. The appropriate signal word for each has been selected using the following guidelines:

**DANGER:** Indicates an imminently hazardous situation that, if not avoided, will result in death or serious injury. This signal word is to be limited to the most extreme situations typically for machine components which, for functional purposes, cannot be guarded.

**WARNING:** Indicates a potentially hazardous situation that, if not avoided, could result in death or serious injury, and includes hazards that are exposed when guards are removed. It may also be used to alert against unsafe practices.

**CAUTION:** Indicates a potentially hazardous situation that, if not avoided, may result in minor or moderate injury. It may also be used to alert against unsafe practices.

If you have questions not answered in this manual or require additional copies or the manual is damaged, please contact your dealer or the manufacturer directly.

---

## IMPORTANT SAFETY INFORMATION!

Working with unfamiliar equipment can lead to careless injuries. Read this manual, and the manual for your tractor, before assembly or operating, to acquaint yourself with the machines. It is the implement owner's responsibility, if this machine is used by any person other than yourself, is loaned or rented, to make certain that the operator, prior to operating:

1. Reads and understands the operator's manuals.
2. Is instructed in safe and proper use.







The use of this equipment is subject to certain hazards which cannot be protected against by mechanical means or product design. All operators of this equipment must read and understand this entire manual, paying particular attention to safety and operating instructions, prior to using. If there is something in this manual you do not understand, ask your supervisor, or your dealer, to explain it to you.







## SAFETY INSTRUCTIONS (continued)



### **SAFETY SIGNS**





-  Keep safety signs clean and legible at all times.
-  Replace safety signs that are missing or have become illegible.
-  Replaced parts that displayed a safety sign should also display the current sign.
-  Safety signs are available from your Distributor or Dealer Parts Department or the factory.

### **How to Install Safety Signs:**

-  Be sure that the installation area is clean and dry.
-  Be sure temperature is above 50°F (10°C).
-  Decide on the exact position before you remove the backing paper.
-  Remove the smallest portion of the split backing paper.
-  Align the sign over the specified area and carefully press the small portion with the exposed sticky backing in place.
-  Slowly peel back the remaining paper and carefully smooth the remaining portion of the sign in place.
-  Small air pockets can be pierced with a pin and smoothed out using the piece of sign backing paper.













### **TIRE SAFETY**

-  Failure to follow proper procedures when mounting a tire on a wheel or rim can produce an explosion which may result in serious injury or death.
-  Do not attempt to mount a tire unless you have the proper equipment and experience to do the job.
-  Inflating or servicing tires can be dangerous. Whenever possible, trained personnel should be called to service and/or mount tires.
-  Always order and install tires and wheels with appropriate capacity to meet or exceed the anticipated weight to be placed on the equipment.

## SAFETY INSTRUCTIONS (continued)













### EQUIPMENT SAFETY GUIDELINES

-  Safety of the operator is one of the main concerns in designing and developing a new piece of equipment. Designers and manufacturers build in as many safety features as possible. However, every year many accidents occur which could have been avoided by a few seconds of thought and a more careful approach to handling equipment. You, the operator, can avoid many accidents by observing the following precautions in this section. To avoid personal injury, study the following precautions and insist those working with you, or for you, follow them.
  
-  In order to provide a better view, certain photographs or illustrations in this manual may show an assembly with a safety shield removed. However, equipment should never be operated in this condition. Keep all shields in place. If shield removal becomes necessary for repairs, replace the shield prior to use.
  
-  Replace any CAUTION, WARNING, DANGER or instruction safety sign that is not readable or is missing. Location of such safety signs is indicated in this booklet.
  
-  Never use alcoholic beverages or drugs which can hinder alertness or coordination while operating this equipment. Consult your doctor about operating this machine while taking prescription medications.
  
-  Review the safety instructions with all users annually.
  
-  This equipment is dangerous to children and persons unfamiliar with its operation. The operator should be a responsible adult familiar with farm machinery and trained in this equipment's operations. **Do not allow persons to operate or assemble this unit until they have read this manual and have developed a thorough understanding of the safety precautions and of how it works.**
  
-  To prevent injury or death, use a tractor equipped with a Roll-Over Protective System (ROPS). Do not paint over, remove or deface any safety signs or warning signs on your equipment. Observe all safety signs and practice the instruction on them.
  
-  Never exceed the limits of a piece of machinery. If its ability to do a job, or to do so safely, is in question - **DON'T TRY IT.**
  
-  Do not modify the equipment in any way. Unauthorized modification may impair the function and/or safety and could affect the life of the equipment.
  
-  In addition to the design and configuration of this implement, including Safety Signs and Safety Equipment, hazard control and accident prevention are dependent upon the awareness, concern, prudence, and proper training of personnel involved in the operation, transport, maintenance, and storage of the machine. Refer also to Safety Messages and Operation instruction in each of the appropriate sections of the Tractor and Blade Manuals. Pay close attention to the Safety Signs affixed to the Tractor and the Rear Blade.

# SAFETY INSTRUCTIONS (continued)















## SAFETY TRAINING

-  Safety is a primary concern in the design and manufacture of our products. Unfortunately, our efforts to provide safe equipment can be wiped out by a single careless act of an operator. It is the operator's responsibility to read and understand ALL Safety and Operating instructions in the manual and to follow these. Accidents can be avoided.
-  In addition to the design and configuration of equipment, hazard control and accident prevention are dependent upon the awareness, concern, prudence and proper training of personnel involved in the operation, transport, maintenance and storage of equipment.
-  Personal protection equipment including hard hat, safety glasses, safety shoes, and gloves are recommended during assembly, installation, operation, adjustment, maintaining, repairing, removal, or moving the implement. Do not allow long hair, loose fitting clothing or jewelry to be around moving parts.
-  **PROLONGED EXPOSURE TO LOUD NOISE MAY CAUSE PERMANENT HEARING LOSS!**  
Tractors with or without implements attached can often be noisy enough to cause permanent, partial hearing loss. We recommend that you wear hearing protection on a full-time basis if the noise in the Operator's position exceeds 80db. Noise over 85db on a long-term basis can cause severe hearing loss. Noise over 90db adjacent to the Operator over a long-term basis may cause permanent, total hearing loss. **NOTE:** Hearing loss from loud noise (from tractors, chain saws, radios, and other such sources close to the ear) is cumulative over a lifetime without hope of natural recovery.
-  Operate the blade only with a tractor equipped with an approved Roll-Over Protective System (ROPS). Always wear your seat belt on tractors equipped with a ROPS. Serious injury or even death could result from falling off the tractor --particularly during a turnover when the operator could be pinned under the ROPS or the tractor.
-  Operate only in daylight or good artificial light.
-  Working with unfamiliar equipment can lead to careless injuries. Read this manual, and the manual for your tractor, before assembly or operating, to acquaint yourself with the machines. It is the implement owner's responsibility, if this machine is used by any person other than yourself, is loaned or rented, to make certain that the operator, prior to operating:
1. Reads and understands the operator's manuals.
  2. Is instructed in safe and proper use.
-  Know your controls and how to stop tractor, engine, and implement quickly in an emergency. Read this manual and the one provided with your tractor.
-  Train all new personnel and review instructions frequently with existing workers. A person who has not read and understood all operating and safety instructions is not qualified to operate the machine. An untrained operator exposes himself and bystanders to possible serious injury or death.
-  Do not allow children to operate this machine.

## SAFETY INSTRUCTIONS (continued)

















### OPERATIONAL SAFETY

-  The use of this equipment is subject to certain hazards which cannot be protected against by mechanical means or product design. All operators of this equipment must read and understand this entire manual, paying particular attention to safety and operating instructions, prior to using. If there is something in this manual you do not understand, ask your supervisor, or your dealer, to explain it to you.
-  Do not reach or place yourself under equipment until it is blocked securely.
-  Take all possible precautions when leaving unit unattended: Disengage PTO, set parking brake, stop engine and remove key from ignition. Park in level area.
-  Do not allow riders on the rear blade or tractor at any time. There is no safe place for any riders.
-  Never operate tractor and implement under trees with low hanging limbs. Operators can be knocked off the tractor and then run over by the implement.
-  Stay alert for holes, rocks and roots in the terrain and other hidden hazards. Keep away from drop-offs.
-  Use extreme care and maintain minimum ground speed when transporting on hillside, over rough ground and when operating close to ditches or fences. Be careful when turning sharp corners.
-  Reduce speed on slopes and sharp turns to minimize tipping or loss of control. Be careful when changing directions on slopes. Do not start or stop suddenly on slopes. Avoid operation on steep slopes.
-  When using a unit, a minimum 20% of tractor and equipment weight must be on tractor front wheels. Without this weight, tractor could tip over, causing personal injury or death. The weight may be attained with a front end loader, front wheel weights, ballast in tires or front tractor weights. When attaining a minimum 20% of tractor and equipment weight on the front wheels, you must not exceed the ROPS weight certification. Weigh the tractor and equipment. Do not guess or estimate!
-  Inspect the entire machine periodically as indicated in the Maintenance Section of this manual. Look for loose fasteners, worn or broken parts, pinched hydraulic hoses, and leaky or loose fittings. Make sure all pins have cotter pins and washers. Serious injury may occur from not maintaining this machine in good working order.
-  In extremely uneven terrain, rear wheel weights, front tractor weight, and/or tire ballast should be used to improve stability.
-  Pass diagonally through sharp dips and avoid sharp drops to prevent “hanging up” tractor and implement. Practice will improve your skills in maneuvering rough terrain.
-  Always cut down slopes; never across the face. Avoid operation on steep slopes. Slow down on sharp turns and slopes to prevent tipping and/or loss of control.

## SAFETY INSTRUCTIONS (continued)



### **OPERATIONAL SAFETY (continued)**

-  All equipment is potentially hazardous. There is no substitute for a cautious, safe-minded operator who recognizes potential hazards and follows reasonable safety practices.
-  When the use of hand tools is required to perform any part of assembly, installation, adjustment, maintaining, repairing, removal, or moving the implement, be sure the tools used are designed and recommended by the tool manufacturer for that specific task.
-  Personal protection equipment including safety glasses, safety shoes, and gloves are recommended during assembly, installation, operation, adjustment, maintaining, repairing, removal, or moving the rear blade.
-  Always use two people to handle heavy, unwieldy components during assembly, installation, removal, or moving the rear blade.
-  Never place any part of your body where it would be in danger if movement should occur during assembly, installation, operation, maintaining, repairing, removal, or moving the implement.
-  Never place yourself between the tractor and implement while hitching or while implement is in operation.
-  Do not work under a raised implement unless it is securely blocked or held in position. Do not depend on the tractor hydraulic system to hold the implement in place.
-  Do not allow others to ride on the tractor with an operator. Riders are subject to injury such as being struck by foreign objects or being thrown off. Riders obstruct the operator's view resulting in unsafe operation. **Never allow anyone to ride on the implement!**
-  Before you operate the rear blade, check over all pins, bolts and connections to be sure all are securely in place. Replace any damaged or worn parts immediately.
-  Use stabilizer bars, adjustable sway chains, or sway blocks on your tractor lift arms to keep the rear blade from swinging side to side. Adjust as tightly as practical for best performance.
-  Keep alert and watch the front as well as the rear when working with the implement.
-  When maneuvering close to buildings or passing through narrow areas, be sure to allow sufficient clearance for the implement.
-  Do not operate close to ditches or creeks. Slow down when operating over rough ground.
-  Always be sure the implement is in the fully raised position when in transport.

## SAFETY INSTRUCTIONS (continued)



### OPERATIONAL SAFETY (continued)



When adjusting the angle of the moldboard assembly, be sure that your feet are never under the rear blade.



Use extreme caution when backfilling deep holes or trenches.



Be careful to avoid catching the rear blade on stumps or other immovable objects.



Use care when working on slopes.



Avoid excessive speed during operation.



Make adjustments only when the implement is attached to the tractor.



When using the rear blade in a reverse position, use extra care. **Do not ram rear blade** into piles of dirt. Tractor lift arms and the rear blade are not built to take high impact loads in this position. **Ramming** backwards can also dislodge operator from seat and/or tractor controls, resulting in possible serious injury or death.



Always ease the tractor into the load. It may be necessary to reposition and take less “bite” on the material to move it safely.



Watch for and avoid hidden obstructions, i.e., buried pipes, rocks, concrete piers, uneven concrete slabs, stumps, etc., when operating.



### MAINTENANCE SAFETY



Good maintenance is your responsibility. Poor maintenance is an invitation to trouble.



Follow good shop practices.  
- Keep service area clean and dry.  
- Be sure electrical outlets and tools are properly grounded.  
- Use adequate light for the job at hand.



Make sure there is plenty of ventilation. Never operate the engine of the towing vehicle in a closed building. The exhaust fumes may cause asphyxiation.



Before working on this machine, drive to a level area, disengage the PTO, lower implement (or if working underneath, raise and block securely), shut off the engine, set the brakes, and remove the ignition keys.



Be certain all moving parts on attachments have come to a complete stop before attempting to perform maintenance.

















Never work under equipment unless it is blocked securely. Never depend on hydraulic system to keep implement in raised position.

## SAFETY INSTRUCTIONS (continued)



















### **MAINTENANCE SAFETY (continued)**

-  Keep all persons away from operator control area while performing adjustments, service, or maintenance.
-  Always use personal protection devices such as eye, hand and hearing protectors, when performing any service or maintenance.
-  Periodically tighten all bolts, nuts and screws and check that all cotter pins are properly installed to ensure unit is in a safe condition.
-  When completing a maintenance or service function, make sure all safety shields and devices are installed before placing unit in service.
-  Remove hydraulic pressure prior to doing any maintenance. Place the blade on the ground or securely blocked up, disengage the PTO, and turn off the engine. Push and pull the remote cylinder lever in and out several times to relieve hydraulic pressure.
-  Never use your hands to locate a hydraulic leak on attachments. Use a small piece of cardboard or wood. Hydraulic fluid escaping under pressure can penetrate the skin.
-  Openings in the skin and minor cuts are susceptible to infection from hydraulic fluid. If injured by escaping hydraulic fluid, see a doctor at once. Gangrene and death can result. Without immediate medical treatment, serious infection and reactions can occur.
-  After servicing, be sure all tools, parts and service equipment are removed.
-  Check to ensure all safety signs are installed and in good condition. (See safety sign section for location drawing.)
-  Do not allow grease or oil to build up on any deck or platform.
-  Never replace hex bolts with less than grade five bolts unless otherwise specified, i.e. shear bolts. Refer to bolt torque chart for head identification marking.
-  Where replacement parts are necessary for periodic maintenance and servicing, genuine factory replacement parts must be used to restore your equipment to original specifications. The manufacturer will not claim responsibility for use of unapproved parts and/or accessories and other damages as a result of their use.
-  If equipment has been altered in any way from original design, the manufacturer does not accept any liability for injury or warranty.
-  A fire extinguisher and first aid kit should be kept readily accessible while performing maintenance on this equipment.

## SAFETY INSTRUCTIONS (continued)









### TRANSPORT SAFETY

-  Comply with state and local laws governing highway safety and movement of farm machinery on public roads.
-  The use of flashing amber lights is acceptable in most localities. However, some localities prohibit their use. Local laws should be checked for all highway lighting and marking requirements.
-  When driving the tractor and equipment on the road or highway under 20 mph (32 kph) at night or during the day, use flashing amber warning lights and a slow moving vehicle (SMV) identification emblem.
-  Always be sure the implement is in the proper raised position for transport. Always center blade on tractor. Never attempt road travel with moldboard offset in traffic lane.
-  Reduce speed when transporting mounted implements to avoid bouncing and momentary loss of steering control.
-  Plan your route to avoid heavy traffic.
-  Always install transport locks, pins or brackets before transporting.
-  Do not drink and drive!
-  Watch for traffic when operating near or crossing roadways.
-  Turn curves or go up or down hills only at a low speed and at a gradual steering angle. Make certain that at least 20% of the tractor's weight is on the front wheels to maintain safe steerage. Slow down on rough or uneven surfaces, and loose gravel.
-  Use extreme care and maintain minimum ground speed when transporting on hillside, over rough ground and when operating close to ditches or fences. Be careful when turning sharp corners.
-  Never allow riders on either tractor or implement. Falling off can kill.
-  Be a safe and courteous driver. Always yield to oncoming traffic in all situations, including narrow bridges, inter-sections, etc.
-  Do not exceed 20 mph (32 kph). Reduce speed on rough roads and surfaces.
-  Use hardened hitch pins with retainers when attaching to pull-type machines.
-  Use a safety chain to prevent unexpected separation with pull-type models.

## SAFETY INSTRUCTIONS (continued)



### **STORAGE SAFETY**

-  Following operation, or when unhooking, stop the tractor, set the brakes, disengage the PTO, shut off the engine and remove the ignition keys.
-  Never unhitch without using the parking stands. The blade is very heavy. Attempting to lift the front of the blade without using jacks or mechanical hoist could cause strains. Allowing the front hitch of the blade to fall suddenly and unexpectedly could result in crushing injury.
-  Store the unit in an area away from human activity.
-  Do not park equipment where it will be exposed to livestock for long periods of time. Damage and livestock injury could result.
-  Do not permit children to play on or around the stored unit.
-  Make sure all parked machines are on a hard, level surface and engage all safety devices.
-  If blocking is used, make sure it is solid and secure before leaving area.

## SAFETY SIGNS

---



## SAFETY SIGNS (continued)

**CAUTION**

Failure to follow safe operating practices can cause property damage and bodily injury.

1. Use tractor hitch away bars to prevent side sway.
2. Never ram blade into dirt or snow piles with blade in reverse position. Ramming backwards can unseat operator from tractor or controls.
3. Keep fingers away from adjusting holes.
4. Reposition blade with tractor on level ground only to prevent blade from swinging or sliding into operator.
5. Watch for and avoid obstructions. Never hit mounds or ridges (especially ice and snow) at high speed as obstructions may be hidden.
6. Read other safety precautions in owner's manual.

Part #101033

**This SAFETY SIGN is located on the frame of your rear blade. Obey ALL Safety Warnings.**

**NOTE:  
If Safety Sign is missing or damaged, replace immediately.**

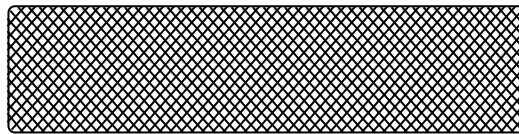

RED – REFLECTOR  
Rear of Moldboard

# READ AND OBEY ALL SAFETY RULES



## SAFETY SIGN LOCATIONS

The types of Safety Sign and locations on the equipment are shown in the illustration below. Good safety requires that you familiarize yourself with the various Safety Signs, the type of warning and the area, or particular function related to that area, that requires your SAFETY AWARENESS.

### SAFETY SIGN LOCATIONS

NO.	PART NO.	DESCRIPTION
1	101033	Caution – Safe Practices
2	101121	Reflector – Red
3	101172	Notice – HP Rating (RB-880)

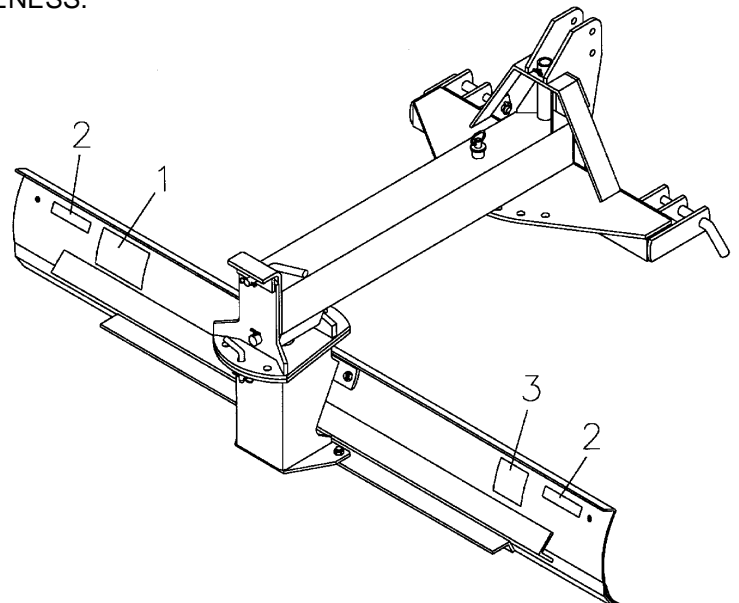

**REMEMBER:** If Safety Signs have been damaged, removed, become illegible or parts replaced without Signs, new Safety Signs must be applied. New Safety Signs are available from your authorized distributor or factory.

# INSTRUCTIONS

---

## TRACTOR REQUIREMENTS AND PREPARATION

---

The Model RB-880 Rear Blade will fit Category I and II 3 pt. Hitches, Category II Quick Hitches and some Category III N Quick Hitches. These blades are designed for use on tractors from 45 to 80 horsepower.

Check the tractor's 3 point hydraulic lift system. It should operate up and down smoothly and hold its position when set. Refer to your tractor owner's manual or dealer for any adjustments necessary to put the 3 point hydraulic lift system in good working order. (I&T shop manuals will list most specifications and adjustment instructions - available from most farm equipment dealers.)

Check the hydraulic system. Be sure the tractor hydraulic oil and filter have been serviced according to the tractor manufacturer's recommendations.

Tractor should be equipped with stabilizer bars, adjustable sway chains, or sway blocks to keep the implement from swinging side to side.

Smaller size tractors may need front counter weights to counter-balance the weight of the implement.

It is recommended that the tractor be equipped with a Rollover Protection System (ROPS) and a seat belt that is used.



**Be sure your tractor is in good condition. Read all the safety precautions and make sure all tractor operators are familiar with the safety rules of operation.**

## ASSEMBLY AND MOUNTING

---

Assembly requirements will vary depending on how the rear blade was shipped. Generally, most model RB-880 (8 ft.) blades are shipped assembled or they are shipped as two bundles on one pallet. The type of truck used and the amount of room on the truck at the time of shipment determines how the blade was shipped.

If your blade requires assembly, follow these steps:

1. Do not attempt to lift heavy parts or assemblies. Use a hoist, crane, forklift, or similar safe mechanical device.

2. Preview the assembly instructions and the exploded views of the blade in your operator's manual and become familiar as to how the parts or assemblies go together.

3. Have good blocking material available.

4. Select an area for assembly that is clean and free from debris.

5. Assemble the 3 pt. hitch mount (Ref. #1) to the front of the main swing arm (Ref. #4). The 1.25" diameter pin (Ref. #5) has a  $\frac{3}{8}$ " x  $2\frac{1}{2}$ " cotter pin installed at the top of the pin and through the collar at top of the hitch mount.

It may be necessary to remove the paint from the front pivot pin prior to installation. If so, it is recommended that the pin be repainted after assembly.

6. Insert the swing shift pin into the main swing beam so that the 3 pt. hitch mount is locked in a straight forward position (swing beam perpendicular to the pull pins). Roll the assembly over so that it is upside down (it will be angled to one side).

Locate the upper circle plate/tilt weldment (Ref. #9) in place at the end of the swing beam and insert the tilt pin (Ref. #13) through just one end. Locate the large end of the main pivot shaft (Ref. #10) through the large center hole in the 3.0 inch shaft with the end of the tilt pin. Push the tilt pin through the hole in the main pivot shaft and through the holes at the other end of the upper circle plate weldment and swing beam. Lock the tilt pin in place by installing the cotter pins at each end.

7. Insert the tilt shift pin (Ref. #19) into the center hole of the upper circle plate/ tilt weldment and the rear plate of the main swing beam to lock it into position.

8. Remove the 2" hex nut (Ref. #12) and the washer from the threaded end of the main pivot shaft.

9. Slide the moldboard head assembly (Ref. #8) on the main pivot shaft with the 2" threaded end through the center plate of the moldboard head assembly.

Install the washer and the 2" hex nut on the threaded end of the main pivot shaft.

Carefully tighten the 2" hex nut so that the moldboard head assembly can turn but not be excessively loose. Adjust the slots in the 2" hex nut until they align with the cotter pin hole and install the cotter pin.

# INSTRUCTIONS (continued)

## ASSEMBLY AND MOUNTING

(continued)

10. Rotate the entire assembly so that it is upright and attach the 3 pt. hitch frame to a tractor 3 pt. hitch.

With the tractor 3 pt. hitch, raise the assembly off the shop floor.

Lay the moldboard assembly on the floor behind the tractor with the cutting edge away from the tractor. Locate so top edge of moldboard and the cutting edge are touching the floor.

Back the tractor so that the rear part of the swing beam and moldboard head assembly are just behind the moldboard. Lower the frame until it is about 2 1/2" above the floor.

11. Carefully lift the upper edge of the moldboard until it is upright and align the holes in the moldboard assembly with those in the moldboard head assembly. Install the four (4) 5/8" bolts with flat washers, lockwashers, and hex nuts. NOTE: The flat washers go over the slots so that the lockwasher can seat on a flat surface.

12. With the tractor 3 pt. hitch, raise the blade fully and install the parking stand.

This would also be the time to install the optional skid shoes if they are being used.

Check all pins and bolts that they are properly installed and locked into position or are properly tightened.

You are now ready to use your rear blade.

## GENERAL SAFETY

Only qualified people familiar with this manual should operate this machine. Operator should wear hard hat, safety glasses, and safety shoes. It is recommended that tractor be equipped with Roll-Over Protective System (ROPS) and a seat belt be used. Check for ditches, stumps, holes, or other obstacles that could upset tractor or damage blade. Always turn off tractor engine, set parking brake, lower blade to ground before dismounting tractor.

Safety is a primary concern in the design and manufacture of our products. Unfortunately, our efforts to provide safe equipment can be wiped out by a single careless act of an operator.

It has been said, "The best safety device is an informed, careful operator." We ask you to be that kind of an operator.



**SAFETY . . .  
YOU CAN LIVE WITH IT!**

**OBEY ALL  
SAFETY WARNINGS!!**

# OPERATING INSTRUCTIONS

The designed and tested safety of this machine depends on it being operated within the limitations as explained in this manual. Be familiar with and follow all safety rules in the manual, on the blade and on the tractor.

The safe operation of this machine is the responsibility of the owner/operator. The operator should be familiar with the blade and tractor and all safety practices before starting operation. Read the safety rules on pages 2 thru 12.

## HITCHING BLADE TO TRACTOR 3 PT. HITCH

The RB-880 blade fits Category I and II 3 pt. hitches and Category II quick hitches.

Never let anyone stand between the rear of the tractor and the rear blade while the tractor is backing up. Always stand to the side until tractor has come to a complete stop and the brakes set or the tractor shift placed in "PARK".

If you are using a quick hitch, having the parking stand at the correct height will make hitching and unhitching much easier. The "correct height" will vary depending on your model tractor and the size of your rear tires.

Make sure all pins are secured and that proper adapters are used on the lower pull pins if a quick hitch is used.

## OPERATION



**Be sure your tractor is in good condition. Read all the safety precautions and make sure all tractor operators are familiar with the safety rules of operation.**



**When using the unit, a minimum 20% of tractor and equipment weight must be on tractor front wheels. Without this weight, tractor could tip up, causing possible loss of control and possible personal injury or death. The weight may be attained with a front end loader, front wheel weights, ballast in tires or front tractor weights. When attaining a minimum 20% of tractor and equipment weight on the front wheels, you must not exceed the ROPS weight certification. Weigh the tractor and equipment. DO NOT GUESS OR ESTIMATE!**

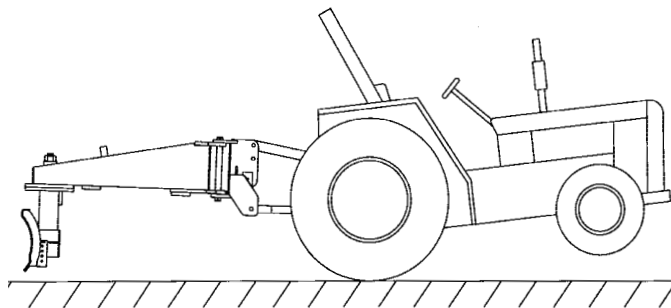

**Figure 1. Tractor Stability**

Make sure tractor is properly weighted.  
Read all Safety Warnings.

## OPERATING TIPS

### **DITCHING (V TYPE DITCH) & TERRACING**

Tilt the moldboard to the desired angle (15° or less) down on the right (or left) by use of the tilt adjustment. If more or less angle is desired adjust the 3 point lower lift arm leveling screw to obtain a finer adjustment.

Adjust the moldboard angle and swing arm to offset the right (or left) corner of the moldboard directly behind the right (or left) rear tire with a 45° to 60° angle between the blade and a line parallel to the rear axle. The combined adjustments of the moldboard pivot and the swing arm will give this angle.

Place the right (or left) rear tractor tire in the bottom of the ditch on succeeding passes until the ditch is completed.

For light ditching and cleaning out ditches, operate the tractor at slow speeds, and be careful not to hit any hidden objects. Operating with a light load on the blade or at high speeds will subject the blade to severe damage from the impact load, if a solid object is hit.

To refill a ditch, offset the swing arm to the right (or left) and rotate the moldboard to push the dirt into the ditch while traveling forward.

### **BACKFILLING & BULLDOZING**

For conventional backfilling, rotate the blade 180° to place the cutting edge to the rear. Adjust the top link so the front of the main frame is level front to rear or is slightly lower in the front.

When operating in the backfill position, keep a light upward lift on the three point lift to keep the blade from digging in. Keep the load centered on the moldboard. Operate at slow speeds to prevent damage to the unit from impact loads. Use extreme care when backfilling deep ditches.

Snow removal can also be done in this position.

# OPERATING INSTRUCTIONS (continued)

Be careful not to hit any hidden object when in the backfill/bulldoze position. Do not ram into a load at any time as this multiplies the forces several times normal and could result in damage to your blade.

**NOTE:** Always use the tractor anti-sway bars, blocks, or chains to prevent blade side-sway. This is a must when using the blade in a reverse position.

## **WARNING!**

When using the rear blade in a reverse position use extra care - **DO NOT RAM REAR BLADE** into dirt piles! Tractor lift arms and the rear blade are not built to take high impact loads in this position. **RAMMING** backwards can also dislodge operator from seat and/or tractor controls, resulting in possible serious injury or death.

## **WARNING!**

A heavy load can cause instability in driving a tractor. Make sure the front of the tractor is properly counterbalanced with weights. Always drive slowly - especially around turns. An unstable tractor could steer badly and possibly tip over, causing injury or death.

## UTILITY

To clean close to a fence or building, offset the swing arm to the right (left) to offset the blade beyond the tractor tire. Be careful not to hang the blade tip as this could result in damage to the blade, or main frame.

For smoothing out loose soil, a fine finish can be obtained by pushing the soil with the back of the moldboard.

## UNEVEN TERRAIN

## **WARNING!**

**Do not operate on steep slopes.**  
**Do not stop, start or change directions suddenly on slopes.**

**Use extreme care and reduce ground speed on slopes and rough terrain.**

**Watch for hidden hazards on the terrain during operation.**

## GRADING

Grading can be accomplished with the cutting edge toward the tractor. Set the moldboard to the desired angle, lower the blade to the ground and set the depth of cut. If the ground is rough, work down the high spots first. It will also help if you can work different directions and use a scarifier to loosen the soil.

Pass diagonally through sharp dips and avoid sharp drops to prevent "hanging up" tractor and blade.

Practice will improve your skills in maneuvering rough terrain.

These suggestions are generalities; best results will be obtained after some experience.

**NOTE:** Do not load either end of the blade heavily. Try to balance the load on both ends of the blade. Take extra care, if the blade is offset, not to overload the long side.

## **CAUTION!**

Watch for and avoid hidden obstructions, i.e., buried pipes, rocks, concrete piers, or uneven slabs of concrete, when operating, or blade damage may occur. This is especially true when removing snow.

**OBEY ALL  
SAFETY  
WARNINGS!!**

# OWNER SERVICE

---



- ▲ Lower blade to ground or block securely, turn tractor engine off, remove key and set brakes or place shift lever in “Park” position.
- ▲ Before working underneath, raise 3-pt. hitch to highest position and block blade securely. Hydraulic system leakdown and failure of mechanical or hydraulic system can cause equipment to drop.
- ▲ Keep all persons away from operator control area while performing adjustments, service or maintenance.
- ▲ Do not run engine indoors – exhaust gases contain carbon monoxide, an odorless and deadly poison.

## MAINTENANCE

---

Inspect the blade for loose, damaged or worn parts and adjust or replace if needed.

Repaint parts where paint is worn or scratched to prevent rust.

Check all bolts and nuts to be sure they are tight.

At the end of the working season or when the blade will not be used for a long period, it is good practice to clean off any dirt that may have accumulated on the blade and any of the moving parts.

Lubricate front swing arm pivot pin.

## TRANSPORTING

---

Pay particular close attention to the Safety Messages regarding transport. Avoid unnecessary injuries and equipment damage by exercising cautious, conscientious travel procedures.

Attaching the blade to the tractor increases the overall length of the working unit. Allow additional clearance for the blade to swing when turning.

Raise the blade as high as possible for transporting. Always transport blade with blade centered on tractor. Never attempt road travel with blade offset into the traffic lane.

## STORING SAFELY

---

- Never store equipment with fuel in the tank inside a building where fumes may reach an open flame or spark. Allow engine to cool before storing in an enclosure.
- Always store blade in a clean, dry location away from children and livestock.
- Storage location should be level and solid to make hitching and unhitching easy.

## OPTIONS

---

### **MODEL SK-6 SKID SHOE INSTALLATION**

Attach the skid shoe mounting bracket to the 2nd and 3rd cutting edge holes from each end of the moldboard. Insert the skid shoe in the mounting bracket and secure with the 1/2" – 13NC x 1 1/2" long square head set screw and jam nut. Be sure the skid shoes are turned so the adjustment holes match the point of the set screw. See parts illustration.

### **MODEL EP-38 END PLATE INSTALLATION**

The end plates mount to the inside of the blade using the end cutting edge hole and the hole in the moldboard directly above it. Replace the cutting edge bolt with the longer 5/8" – 11NC x 2" long carriage bolt provided. On earlier models it may be necessary to match drill the upper 11/16" Dia. hole in the moldboard. Install the upper 5/8" – 11NC carriage bolt. See parts illustration.



**SAFETY . . .  
YOU CAN LIVE WITH IT!**

# TROUBLESHOOTING GUIDE

PROBLEM	POSSIBLE CAUSE	POSSIBLE REMEDY
<b>Blade will not penetrate soil.</b>	<ol style="list-style-type: none"> <li>1. Cutting edge dull.</li> <li>2. Blade set too straight.</li> <li>3. Soil too hard.</li> </ol>	<p>Replace cutting edge.</p> <p>Increase 3 pt. hitch toplink length.</p> <p>Loosen soil with scarifiers or disk. Wait for rain.</p>
<b>Moldboard digging in too much.</b>	<ol style="list-style-type: none"> <li>1. Blade pitch excessive.</li> <li>2. Soft ground.</li> </ol>	<p>Adjust toplink (shorten).</p> <p>Install skid shoes. Wait for dryer soil.</p>
<b>3 Pt. hitch frame bent.</b>	<ol style="list-style-type: none"> <li>1. Hitting hidden objects in backfill position or ramming backwards at high speed into hard piles of soil.</li> <li>2. Using too large of tractor.</li> </ol>	<p>Use slow speed when in unknown soil conditions. Always backfill at slow speed.</p> <p>Preferably use tractor of recommended horsepower. Slow down and use extra care.</p>
<b>Bent moldboard.</b>	<ol style="list-style-type: none"> <li>1. Small curve is normal from welding.</li> <li>2. Hitting hidden objects.</li> <li>3. Using too large of tractor or one that is heavily weighted and has four wheel drive.</li> </ol>	<p>Can be removed, but will not effect blade operation.</p> <p>Know soil conditions. Use slow speed when soil conditions unknown.</p> <p>Preferably use tractor of recommended horsepower. Slow down and use extra care.</p>
<b>Unable to hold level grade.</b>	<ol style="list-style-type: none"> <li>1. Tractor draft control lifting blade.</li> <li>2. Soil too hard.</li> </ol>	<p>Set tractor draft control.</p> <p>Use scarifiers.</p>

RB-880 PARTS VIEW

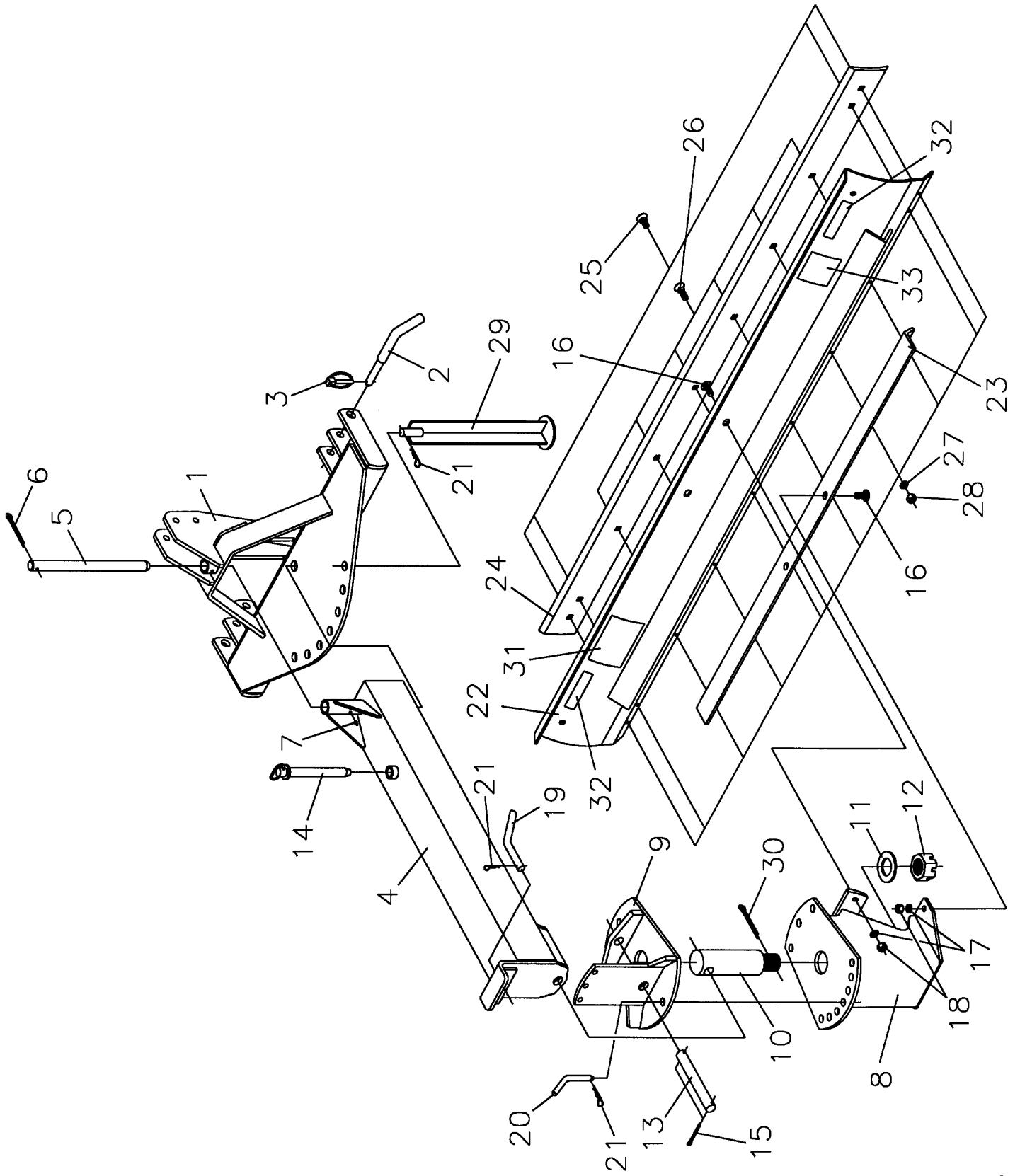

RB-880 PARTS LIST

Ref. No.	Part No.	Description	No. Req'd.
1	347530	3 Pt. Frame Weldment	1
2	347535	Pull Pin	2
3	590034	Linch Pin 1/4" (AK-61)	2
4	347540	Swing Beam Weldment	1
5	347527	Front Pivot Pin	1
6	2504148	Cotter Pin 3/8" x 2 1/2"	1
7	2504049	Grease Zerk 5/16"	1
8	347555	Moldboard Head Weldment	1
9	347520	Circle Plate/Tilt Weldment	1
10	347525	Main Pivot Shaft	1
11	2501025	Hardened Washer 2" ID	1
12	2500080	Nut 2"-4 1/2NC, Slotted Hex	1
13	347528	Tilt Pin	1
14	347516	Handle Shift Pin	1
15	2504068	Cotter Pin 1/4" x 1 3/4"	2
16	2503200	Bolt 5/8"-11NC x 1 1/2" Carriage Head Gr.5	4
17	2502007	Washer 5/8" Spring Lock	4
18	2500013	Nut 5/8"-11NC Full Hex	4
19	803637	Upper Shift Pin	1
20	347524	Lower Shift Pin	1
21	590187	Hair Clip Pin (AK-2704)	3
	347515	Moldboard Assembly (#22 thru #28)	1
22	347510	Moldboard Weldment	1
23	347512	Moldboard Reinforcement	1
24	350105	Cutting Edge 8 Ft.	1
25	2503045	Bolt 5/8"-11NC x 1 1/2" Plow Head Gr.2	4
26	2503179	Bolt 5/8"-11NC x 2" Plow Head Gr.2	6
27	2502007	Washer 5/8" Spring lock	10
28	2500013	Nut 5/8"-11NC Full Hex	10
29	347514	Blade Stand Weldment	1
30	2504013	Cotter Pin 3/8" x 4"	1
31	101033	Safety Sign - Caution (Blades)	1
32	101121	Safety Sign - Red Reflector	2
33	101172	Safety Sign - Notice (Warranty)	1

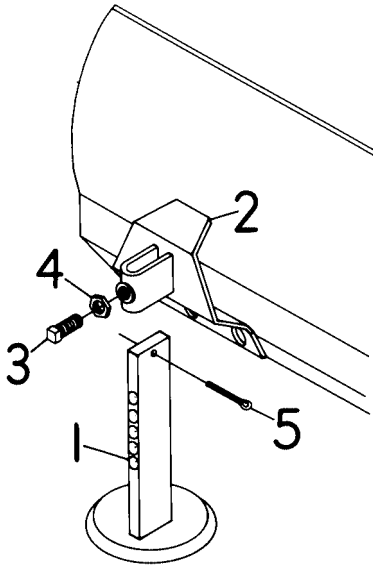

### SK-6 (OPTIONAL)

REF. NO.	PART NO.	DESCRIPTION	NO. REQ.
1	346632	Skid Shoe Weldment	2
2	346635	Mount Weldment	2
3	2503203	Set Screw $\frac{1}{2}$ " – 13NC x $1\frac{1}{2}$ " Sq. Head	2
4	2500058	Nut $\frac{1}{2}$ " – 13NC Hex Jam	2
5	2504068	Cotter Pin $\frac{1}{4}$ " x $1\frac{3}{4}$ "	2
N/S	2503179	No. 3 Plow Head Bolt $\frac{5}{8}$ " – 11NC x 2"	4

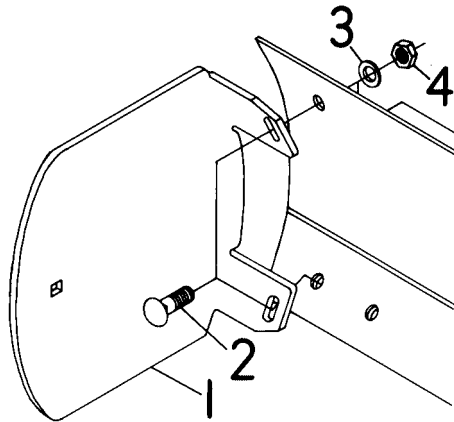

### EP-38 (OPTIONAL)

REF. NO.	PART NO.	DESCRIPTION	NO. REQ.
1	346621	End Plate	2
2	2503136	Bolt $\frac{5}{8}$ " – 11NC x 2" Carriage Head Grade 5	4
3	2502007	Washer $\frac{5}{8}$ " Springlock	4
4	2500013	Nut $\frac{5}{8}$ " – 11NC Full Hex	4

# LIMITED WARRANTY

Worksaver warrants to the original purchaser of any new Rear 3 Pt. Blade (Model RB-880), that the equipment be free from defects in material and workmanship for a period of one (1) year for non-commercial, state, and municipalities'. Use ninety (90) days for commercial use from date of retail sale.

Replacement or repair parts installed in the equipment covered by this warranty are warranted for ninety (90) days from the date of purchase of such part or to the expiration of the applicable new equipment warranty period, whichever occurs later.

Such parts shall be provided at no cost to the user during regular working hours. Worksaver reserves the right to inspect any equipment or parts which are claimed to have been defective in material or workmanship.

## **SPECIAL WARRANTY PROVISION**

Warranty shall only apply to defects in material and workmanship. In no case shall Worksaver, Inc. be liable to the purchaser for the bending or breakage of any part of the blade by abuse or misuse, such as striking hidden objects, grubbing stumps, or using tractors larger than the blades maximum horsepower rating whether intentional or unintentional.

## **DISCLAIMER OF IMPLIED WARRANTIES & CONSEQUENTIAL DAMAGES**

Worksaver's obligation under this warranty, to the extent allowed by law, is in lieu of all warranties, implied or expressed, including implied warranties of merchantability and fitness for a particular purpose and any liability for incidental and consequential damages with respect to the sale or use of the items warranted. Such incidental and consequential damages shall include but not be limited to: transportation charges other than normal freight charges; cost of installation other than cost approved by Worksaver; duty; taxes; charges for normal service or adjustments; loss of crops or any other loss of income; rental of substitute equipment, expenses due to loss, damage, detention or delay in the delivery of equipment or parts resulting from acts beyond the control of Worksaver.

## **THIS WARRANTY SHALL NOT APPLY:**

1. To vendor items which carry their own warranties, such as hydraulic cylinders, hoses, tires, and tubes.
2. If the unit has been subjected to misapplication, abuse, misuse, negligence, fire or other accident.
3. If parts not made or supplied by Worksaver have been used in connection with the unit, if, in sole judgement of Worksaver such use affects its performance, stability, or reliability.
4. If the unit has been altered or repaired outside of an authorized Worksaver dealership in a manner which, in the sole judgement of Worksaver affects its performance, stability or reliability.
5. To normal maintenance service and normal replacement items such as gearbox lubricant, hydraulic fluid, worn blades, or to normal deterioration of such things as belts and exterior finish, due to use or exposure.
6. To expendable or wear items such as teeth, chains, skid shoes, cutting edges, and other items that in the company's sole judgement is a wear item.

NO EMPLOYEE OR REPRESENTATIVE OF WORKSAVER IS AUTHORIZED TO CHANGE THIS WARRANTY IN ANY WAY OR GRANT ANY OTHER WARRANTY UNLESS SUCH CHANGE IS MADE IN WRITING AND SIGNED BY WORKSAVER'S SERVICE MANAGER, POST OFFICE BOX 100, LITCHFIELD, ILLINOIS 62056-0100.



## SAFETY PRECAUTIONS

**MOST ACCIDENTS OCCUR BECAUSE OF NEGLIGENCE OR CARELESSNESS.**

**AVOID NEEDLESS ACCIDENTS BY FOLLOWING ALL OF THE SAFETY PRECAUTIONS LISTED BELOW.**

- Machinery should be operated only by those who are responsible and are authorized to do so.
- Stop the engine, lower all equipment, lock the brakes, and remove the ignition key before dismounting from the tractor.
- Never stand between tractor and implement while tractor is being backed to hitch.
- Loose fitting clothing should not be worn, to avoid catching on various parts.
- Detach implement in area where children normally do not play.
- When performing adjustments or maintenance on an implement, first lower it to the ground or block it securely at a workable height.
- Only a qualified operator should be permitted on tractor when in operation; no riders allowed.
- Make certain everyone is in the clear before starting tractor or raising or lowering equipment.
- Operate the tractor and implement only while seated in the driver's seat.
- Reduce speed when transporting mounted implements to avoid bouncing and momentary loss of steering control.
- A heavy load can cause instability of the tractor. Use extreme care during road travel. Slow down on turns and watch out for bumps. Tractor may need front counter-weights to counter-balance the weight of the implement.
- Reduce speed on hillsides or curves so there is no danger of tipping.
- Avoid driving too close to the edge of ditches or creeks.
- Do not transport implement on public roads without reflectors and slow moving vehicle emblem in daylight and with approved warning lights at night and other periods of poor visibility.
- Due to the width of some implements, use extra caution on highways, farm roads, and when approaching gates.
- Always be sure the implement is in the proper position for transport.
- Keep alert and watch the front as well as the rear when working with the implement.

## OWNER'S MANUAL

**MODEL NO.  
RB-880**

**WHEN ORDERING  
REPAIR PARTS,  
ALWAYS GIVE  
THE FOLLOWING  
INFORMATION:**

1. PART NUMBER
2. PART DESCRIPTION
3. MODEL NUMBER
4. NAME OF ITEM

SEPTEMBER 1999

**MAKE EVERY DAY  
A HOLIDAY  
FROM ACCIDENTS**

## 3 PT. REAR BLADE

For Cat. I and II  
3 Pt. Hitch Tractors

WORKSAVER, INC.

P.O. BOX 100 LITCHFIELD, IL 62056-0100 (217) 324-5973  
WEB: <http://www.worksaver.com> E-MAIL: [sales@worksaver.com](mailto:sales@worksaver.com)