

# OWNER'S/ OPERATOR'S MANUAL

**MODEL NO.  
R-130**

## **CAUTION**

For Safe Operation  
Read Rules And  
Instructions Carefully

SINO LEEINGLES, PIDA AYUDA  
A AIGUIEN QUE SI LO LEA  
PARA QUE LE TRADUZCA LAS  
MEDIDAS DE SEGURIDAD.

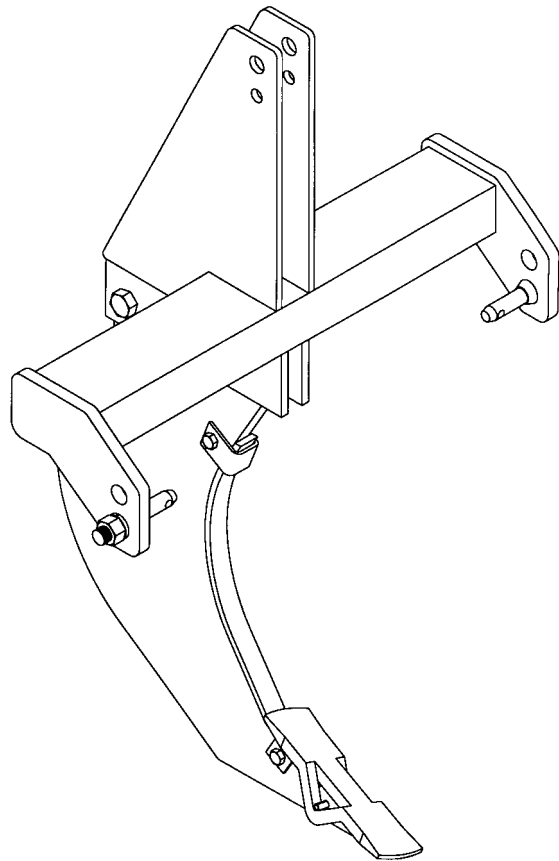

## **3 Pt. Single Shank Subsoiler & Rootcutter**

**Safety Instructions  
Tractor Preparation  
Operating Instructions**

**Assembly & Mounting  
Maintenance  
Repair Parts**

## **CAUTION**

**THE FOLLOWING SAFETY PRECAUTIONS SHOULD BE THOROUGHLY UNDERSTOOD  
BEFORE ATTEMPTING TO BEGIN ASSEMBLING THIS MACHINE**

1. Select an area for assembly that is clean and free of any debris which might cause persons working on the assembly to trip.
2. Do not lift heavy parts or assemblies. Use crane, jack, tackle, fork trucks or other mechanical devices.
3. Preview the assembly instructions in your operator's manual before proceeding further.
4. If the assembly instructions call for parts or assemblies to be blocked up, use only blocking material that is in good condition and is capable of handling the weight of the assembly to be blocked. Also insure that the blocking material is on a clean, dry surface.
5. Never put hands, or any part of body, under blocked up assemblies if at all possible.
6. After completing assembly, thoroughly inspect the machine to be sure that all nuts, bolts, hydraulic fittings or any other fastened assemblies have been thoroughly tightened.
7. Before operating the machine, thoroughly read the operation section of your operator's manual.
8. Before operating, read the maintenance section of your operator's manual to be sure that any parts requiring lubrication, such as gearboxes, are full, to avoid any possible damage.
9. **Before operating equipment – If you have any questions regarding the proper assembly or operation, contact your dealer or representative.**

TABLE  
OF  
CONTENTS

SAFETY INFORMATION ..... 2  
INSTRUCTIONS ..... 5  
OPERATION INSTRUCTIONS ..... 6  
OWNER SERVICE ..... 8  
TROUBLE-SHOOTING GUIDE ..... 8  
REPLACEMENT PARTS ..... 9

SINO LEEINGLES, PIDA AYUDA A AIGUIEN QUE SI LO LEA PARA QUE LE TRADUZCA LAS MEDIDAS DE SEGURIDAD.

**STATEMENT  
OF POLICY**

It is the policy of Worksaver, Inc. to improve its products where it is possible and practical to do so. Worksaver, Inc. reserves the right to make changes or improvements in design and construction at any time, without incurring the obligation to make these changes on previously manufactured units.

**TO THE OWNER :**

Read this manual before using your Subsoiler. This manual is provided to give you the necessary operating and maintenance instructions for keeping your subsoiler in top operating condition. Please read this manual thoroughly. Understand what each control is for and how to use it. Observe all safety signs on the machine and noted throughout the manual for safe operation of implement. Keep this manual handy for ready reference.

Like all mechanical products, it will require cleaning and upkeep.

Use only genuine Worksaver service parts. Substitute parts will void the warranty and may not meet standards required for safe and satisfactory operation. Record the model and serial number of your subsoiler here:

Model: \_\_\_\_\_ Serial Number: \_\_\_\_\_

---

---

**RETAIL CUSTOMER'S RESPONSIBILITY**

**It is the Retail Customer and/or Operator's responsibility to read the Operator's Manual, to operate, lubricate, maintain, and store the product in accordance with all instructions and safety procedures. Failure of the operator to read the Operator's Manual is a misuse of this equipment.**

**It is the Retail Customer and/or Operator's responsibility to inspect the product and to have any part(s) repaired or replaced when continued operation would cause damage or excessive wear to other parts or cause a safety hazard.**

**It is the Retail Customer's responsibility to deliver the product to the authorized Worksaver Dealer, from whom he purchased it, for service or replacement of defective parts which are covered by warranty. Repairs to be submitted for warranty consideration must be made within forty-five (45) days of failure.**

**It is the Retail Customer's responsibility for any cost incurred by the Dealer for traveling to or hauling of the product for the purpose of performing a warranty obligation or inspection.**

# To the Owner/Operator/Dealer

All implements with moving parts are potentially hazardous. There is no substitute for a cautious, safe-minded operator who recognizes the potential hazards and follows reasonable safety practices. The manufacturer has designed this implement to be used with all its safety equipment properly attached to minimize the chance of accidents.

## BEFORE YOU START!!

**Read the safety messages on the implement and shown in your manual.  
Observe the rules of safety and common sense!**



**THIS SYMBOL MEANS**

- ATTENTION!
- BECOME ALERT!
- YOUR SAFETY IS INVOLVED!

THIS SAFETY ALERT SYMBOL IDENTIFIES IMPORTANT SAFETY WARNING MESSAGES. CAREFULLY READ EACH WARNING MESSAGE THAT FOLLOWS. FAILURE TO UNDERSTAND AND OBEY A SAFETY WARNING, OR RECOGNIZE A SAFETY HAZARD, COULD RESULT IN AN INJURY OR DEATH TO YOU OR OTHERS AROUND YOU. THE OPERATOR IS ULTIMATELY RESPONSIBLE FOR THE SAFETY OF HIMSELF, AS WELL AS OTHERS, IN THE OPERATING AREA OF THE TRACTOR AND ATTACHED EQUIPMENT.

---

## UNDERSTAND SIGNAL WORDS

Note the use of the signal words **DANGER**, **WARNING** and **CAUTION** with the safety messages. The appropriate signal word for each has been selected using the following guidelines:

**DANGER:** Indicates an imminently hazardous situation that, if not avoided, will result in death or serious injury. This signal word is to be limited to the most extreme situations typically for machine components which, for functional purposes, cannot be guarded.

**WARNING:** Indicates a potentially hazardous situation that, if not avoided, could result in death or serious injury, and includes hazards that are exposed when guards are removed. It may also be used to alert against unsafe practices.

**CAUTION:** Indicates a potentially hazardous situation that, if not avoided, may result in minor or moderate injury. It may also be used to alert against unsafe practices.

If you have questions not answered in this manual or require additional copies or the manual is damaged, please contact your dealer or the manufacturer directly.

---

## IMPORTANT SAFETY INFORMATION!















Working with unfamiliar equipment can lead to careless injuries. Read this manual, and the manual for your tractor, before assembly or operating, to acquaint yourself with the machines. It is the implement owner's responsibility, if this machine is used by any person other than yourself, is loaned or rented, to make certain that the operator, prior to operating:

1. Reads and understands the operator's manuals.
2. Is instructed in safe and proper use.





















The use of this equipment is subject to certain hazards which cannot be protected against by mechanical means or product design. All operators of this equipment must read and understand this entire manual, paying particular attention to safety and operating instructions, prior to using. If there is something in this manual you do not understand, ask your supervisor, or your dealer, to explain it to you.

## SAFETY INFORMATION (continued)

-  All equipment is potentially hazardous. There is no substitute for a cautious, safe-minded operator who recognizes potential hazards and follows reasonable safety practices.
-  When the use of hand tools is required to perform any part of assembly, installation, adjustment, maintaining, repairing, removal of the hitch kit, be sure the tools used are designed and recommended by the tool manufacturer for that specific task.
-  Personal protection equipment including safety glasses, safety shoes, and gloves are recommended during assembly, installation, operation, adjustment, maintaining, repairing, removal of the hitch kit.
-  Always use two people to handle heavy, unwieldy components during assembly, installation, removal of the hitch kit.
-  Never place any part of your body where it would be in danger if movement should occur during assembly, installation, operation, maintaining, repairing, removal of the hitch kit.
-  Never place yourself between the tractor and implement while implement is in operation.
-  Do not work under a raised implement unless it is securely blocked or held in position. Do not depend on the tractor hydraulic system to hold the implement in place.
-  A heavy load can cause instability of the tractor. Use extreme care during travel. Slow down on turns and watch out for bumps. The tractor may need front counter-weights to counter-balance the weight of the implement.
-  Never use alcoholic beverages or drugs which can hinder alertness or coordination while operating this equipment. Consult your doctor about operating this machine while taking prescription medications.
-  Do not allow others to ride on the tractor with an operator. Riders are subject to injury such as being struck by foreign objects or being thrown off. Riders obstruct the operator's view resulting in unsafe operation. **Never allow anyone to ride on the implement!**
-  Before you operate the equipment, check over all pins, bolts and connections to be sure all are securely in place. Replace any damaged or worn parts immediately.
-  Do not allow anyone who is not familiar with the safety rules and operation instructions to use this equipment.
-  Never allow children to operate or be around equipment.
-  Use stabilizer bars, adjustable sway chains, or sway blocks on your tractor lift arms to keep implements from swinging side to side. Adjust as tightly as practical for best performance.

## SAFETY INFORMATION (continued)

-  Keep alert and watch the front as well as the rear when working with equipment.
-  When maneuvering close to buildings or passing through narrow areas, be sure to allow sufficient clearance for the implement and tractor.
-  Do not operate close to ditches or creeks. Slow down when operating over rough ground.
-  Always be sure the implement is in the fully raised position when in transport.
-  When removing, or adjusting equipment, be sure that your feet are never under the implement.
-  Be careful to avoid catching the implements on stumps or other immovable objects.
-  Use extra care when working on slopes.
-  Avoid excessive speed during operation.
-  Make implement adjustments only when the implement is attached to the tractor.
-  Do not replace shear bolt with a hard bolt. Damage could result to implement and sudden stop to tractor could dislodge operator from tractor seat causing injury.
-  Always ease the tractor into the load. It may be necessary to reposition and take less “bite” on the material to move it safely.
-  Watch for and avoid hidden obstructions, i.e., buried pipes, rocks, concrete piers, uneven concrete slabs, stumps, etc., when operating equipment.
-  Never operate tractor and implement under trees with low hanging limbs. Operators can be knocked off the tractor and then run over by the implement.
-  When driving the tractor and equipment on the road or highway under 20 mph (32 kph) at night or during the day, use flashing amber warning lights and a slow moving vehicle (SMV) identification emblem.
-  Always be sure the implement is in the proper raised position for transport.
-  Reduce speed when transporting mounted implements to avoid bouncing and momentary loss of steering control.
-  Be a safe and courteous driver. Always yield to oncoming traffic in all situations, including narrow bridges, intersections, etc.
-  Do not exceed 20 mph (32 kph). Reduce speed on rough roads and surfaces.

# INSTRUCTIONS

---

## TRACTOR REQUIREMENTS AND PREPARATION

---

The model R-130 Subsoiler can be used on both Category I tractors (30 hp and larger) and Category II tractors.

It is recommended that only tractors with wide front axles be used with this implement. Tricycle front wheel arrangements are inherently unstable and tractor roll-over accidents are more likely to occur.

The tractor also needs lift arm stabilizer bars or sway blocks to control side movement of the implement.

Check the tractor's 3 pt. hydraulic system. Refer to your tractor operator's manual or dealer for any adjustments necessary to put the hydraulic system in good working order. (I&T shop manuals will list most specifications and adjustment instructions – available from most farm equipment dealers.)

Check the hydraulic system. Be sure the tractor hydraulic oil and filter have been serviced according to the tractor manufacturer's recommendations.

Smaller size tractors may need front counter weights to counter-balance the weight of the implement.

Be sure tires and rims are in good condition. Inflate tires to the proper recommended air pressure.

It is recommended that a ROPS (Roll-Over Protection Structure) and a seat belt be installed on all tractors. Contact your local dealer for a ROPS for your tractor.



**Be sure tractor is in good condition. Read all the safety precautions and make sure all tractor operators are familiar with the safety rules of operation.**

The operator is responsible for the safe operation of the implement. The operator must be properly trained. Operators should be familiar with the implement and tractor and all safety practices before starting operation. Read all safety rules.

## ASSEMBLY AND MOUNTING

---

Refer to the repair parts drawing in this manual to get an idea of how the parts need to be assembled for each individual implement.

The rear shank mounting bolt (Ref. #3) is a 7/8" x 3 1/2" bolt that is the pivot for the shank if the front 5/8" x 3 1/2" bolt shears. The front bolt must be a grade 2 (soft) bolt to be a shear bolt.

**NOTE: USE OF A GRADE 5 OR HIGHER SHEAR BOLT MAY RESULT IN DAMAGE TO THE IMPLEMENT.**

Make sure the lower draw pins (pull pins) are installed correctly for your tractor.

Draw pins should be assembled inward for category "I" hitch applications and outward for category II hitches.

Insert the draw pins into the ball sockets in the lower lift arms of the tractor 3 pt. hitch. Lock in place with linch pins (not furnished.)

Attach the mast of the 3 pt. main frame by installing the tractor center link (toplink) with a topline pin (not furnished.)

Adjust the topline assembly to obtain the correct angle of the implement. Check the tractor 3 pt. lift arms and adjust to level the implement from side to side.



**Read manual before operating.**

## SAFETY TRAINING

---

- Know your controls and how to stop tractor and engine quickly in an emergency. **READ THIS MANUAL AND THE ONE PROVIDED WITH YOUR TRACTOR.**
- To avoid accident or injury, do not allow anyone to operate this equipment without proper instructions. Any person who operates this equipment must be instructed in and be capable of the safe operation of the tractor implement and all controls.
- Do not allow children to operate this machine.



**A heavy load can cause instability in driving a tractor. Make sure the front of the tractor is properly counterbalanced with weights. Always drive slowly - especially around turns. An unstable tractor could steer badly and possibly tip over, causing injury or death.**

# OPERATING INSTRUCTIONS

---

## GENERAL SAFETY

---

Only qualified people familiar with this manual should operate this machine. It is recommended that tractor be equipped with Roll-Over Protective System (ROPS) and a seat belt be used. Check for ditches, stumps, holes, or other obstacles that could upset tractor or damage implement. Always turn off tractor engine, set parking brake, lower implement to ground before dismounting tractor.

The safe operation of this machine is the responsibility of the owner/operator. The operator should be familiar with the implement and tractor and all safety practices before starting operation. Read the safety rules on pages 2 thru 4.

It is important that your tractor be properly prepared to obtain the best and safest operation from your subsoiler. The following procedures are recommended. In addition, review your tractor manual for instructions on adjustments and use of three point hitch control features, ballast weighting, and tire pressures.

## BALLAST WEIGHTING

Mounted subsoilers normally require added weight to the tractor to maintain proper stability and traction during operation and transport.

- 1) An 80% tire fill of ballast fluid is usually enough for the rear tires. It may be necessary in some cases to add metal weights to prevent tire slippage.
- 2) Add front end weights if there is floating action on the front of the tractor when subsoiling.
- 3) To determine proper weighting, check the soil between the rear tire lug prints. When pulling a full load, the soil should be broken or shifted slightly. Too much weight will cause sharp, firm tread marks. Slippage results from insufficient weight, will show up in poorly defined tread marks.

## TIRE INFLATION

Proper tire inflation can be determined by checking the tire lugs on a cement surface. The tire is correctly inflated if approximately 90% of the lug makes contact with the surface when the tractor is fully weighted.

## OPERATION

---

For proper operation, level the Subsoiler by adjusting the tractor linkage. This will assure that the shank will run straight.

The tractor 3pt. hydraulic lift system should be set to transfer most of the Subsoiler's weight and draft to the tractor to maximize traction (There may not be a 3pt. Draft control on some small tractors – Refer to Tractor Owner's Manual.)

The model R-130 Subsoiler (or Ripper) can loosen soil down to a depth of 20-24 inches. Compacted soil or "Hardpan" usually occurs in soil depths of 8-14 inches.

Breaking up this "Hardpan" layer will allow better soil drainage and in dry periods, allow plant roots to go deeper to obtain moisture.

Hardpan or compacted soil layers is sometime caused by compaction from wheel tractors or foot traffic.

Do not attempt to rip or subsoil when the soil is wet. Wet soil will not shatter and may cause more compaction.

It is recommended that you dig a hole or use a soil probe to identify the "Hardpan" layer. The objective is to operate the point just below the hardpan layer.

The deeper you operate the Subsoiler (or Ripper), the more tractor horsepower and traction will be required.

In very hard soil or in dry conditions (or with a small tractor), it may not be possible to operate the Ripper at the desired depth. In these cases, it may be necessary to make several passes. (Increase the depth with each pass until the desired depth is reached.)

The best "shattering" action will be realized at forward speeds of 3½ to 5 miles per hour. It is not recommended to exceed 5 MPH as it will only increase fuel consumption, horsepower required, and wear on the tractor and implement.

Most soil types will require ripping or subsoiling every 2-3 years. Some soils will require this every year. It is suggested, that if you subsoil a field one direction one year, that you operate the Ripper diagonal to that direction when you "Rip" again. In some fields it might be best to "Rip" at an angle and then again at a cross angle in following operations.

# OPERATING INSTRUCTIONS (continued)

Ripping or subsoiling passes should be from 30" to 48" apart. In garden spots it is suggested to rip directly under the row of a planned crop. This will allow the best drainage and root development for the crop.

The point of the R-130 Ripper is reversible. When the first point wears back, just knock out the rollpin, reverse the point, and re-install the rollpin.

Do not let the point wear back so far that wear occurs on the lower shank body. In tough abrasive soils, if wear occurs on the main shank, it is recommended that you take the shank to a local welding shop and have a few beads of hardsurface weld put on the leading edge of the wear strip. This will increase the life of the shank.

## ROOT CUTTING

Trees in fence rows or along the edge of woods will extend their roots out into a field to take advantage of nutrients and moisture located there. This results in poor crop performance in these locations.

Operating the R-130 subsoiler 16-20 inches deep along the edge of the field will cut the tree roots and stop them from "stealing" the nutrients and moisture from the crop.

If you stay at least 15 feet from the tree trunk, the cutting of the roots will not harm the tree.

It is usually advisable to make a few passes to make sure the subsoiler point is down to the depth necessary to cut the roots.



**Underground utilities – Contact appropriate agencies to determine if hazardous items are buried under the field BEFORE OPERATING! Be certain underground utilities have been called to locate underground electric, gas, telephone, and other lines. Check your telephone book for calling instructions. Be sure operator is properly informed. WHEN IN DOUBT, DO NOT SUBSOIL!**



**A heavy load can cause instability in driving a tractor. Make sure the front of the tractor is properly counterbalanced with weights. Always drive slowly - especially around turns. An unstable tractor could steer badly and possibly tip over, causing injury or death.**

## FRONT END BALLAST

Front end ballast may be required for stability and steering control when weight is transferred to the back tires as the subsoiler is raised. As a general guide:

- Ballast the tractor (less subsoiler) so that approximately  $\frac{1}{3}$  of the tractor weight is on the front wheels.
- When mounted subsoiler is raised, the reaction on the front wheels should be less than 20% of tractor weight.
- Add additional ballast as required for stability during operation and transport. Tractor front end ballast may not always maintain tractor stability if tractor is operated on rough terrain at high speeds. In such cases, reduce speed and exercise caution.

## UNEVEN TERRAIN



**Do not operate on steep slopes.**

**Do not stop, start or change directions suddenly on slopes.**

**Use extreme care and reduce ground speed on slopes and rough terrain.**

**Watch for hidden hazards on the terrain during operation.**

## SHEARBOLT REPLACEMENT

Your subsoiler is equipped with a grade 2 shearbolt. When replacing a broken bolt, use only the same size bolt of grade 2 or lower.



**Replacement of the shearbolt with a bolt higher than grade 2 may result in serious damage to subsoiler or injury to operator and voids the manufacturer warranty.**



**SAFETY . . .  
YOU CAN LIVE WITH IT!**



# OPERATING INSTRUCTIONS (continued)

## TRANSPORTING

---

Pay particular close attention to the Safety Messages regarding transport. Avoid unnecessary injuries and equipment damage by exercising cautious, conscientious travel procedures.

Raise the subsoiler as high as possible for transporting.



**When traveling on public roads, whether at night or during the day, use accessory light and devices for adequate warnings to operators of other vehicles. Comply with all federal, state and local laws.**

## MAINTENANCE

---



▲ **Lower implement to ground or block securely, turn tractor engine off, remove key and set brakes or place shift lever in "Park" position.**

▲ **Before working underneath, raise 3-pt. hitch to highest position and block securely. Hydraulic system leakdown and failure of mechanical or hydraulic system can cause equipment to drop.**

1. Check all nuts and bolts and make sure they are tight.
2. Check points for wear and damage. Replace when necessary.
3. After seasonal use, paint the shanks and points to prevent excessive rusting during extended non-use periods. This will reduce the scour time when you use the implement again.

### 4. SHEAR BOLT REPLACEMENT

If a shear bolt is sheared due to hitting an obstruction, or operating in very hard ground, replace it with a  $\frac{5}{8}$  inch grade #2 bolt. (No markings on head)

**NOTE: USE OF A GRADE 5 OR HARDER SHEAR BOLT MAY RESULT IN DAMAGE TO THE IMPLEMENT.**

## TROUBLE - SHOOTING

---

### **PROBLEM: Tractor will not pull Implement**

1. Insufficient horsepower – Use larger, heavier tractor.
2. Soil too wet – Let soil dry.
3. Soil too hard and dry – Wait for rain.
4. Points too dull – Replace points.
5. Insufficient traction – (See tire slippage below)
6. Attempting to operate too deep – Reduce depth setting and make several passes, gradually increasing depth.

### **PROBLEM: Excessive tractor tire slippage**

1. Tractor too small – Use larger, heavier tractor.
2. Insufficient traction – Dual rear tire or add ballast, increase draft control, operate at shallower depth.
3. Ground was tilled prior to subsoiling (Topsoil too loose) – Subsoil first.
4. Operating too deep – See #6 above.

### **PROBLEM: Large clods**

1. Soil too hard and dry – Wait for rain.
2. Operating too shallow – Operate deeper.
3. Wire or foreign object on shank – Remove object.

### **PROBLEM: Shearing bolts**

1. Wrong size shear bolt – Use  $\frac{5}{8}$ " grade 2.
2. Too much load – Reduce speed or operating depth.
3. Hitting rocks or obstructions – Remove (if possible).
4. Soil too hard and dry – Wait for rain.

### **PROBLEM: Excessive point wear**

1. Soil too dry – Wait for rain.
2. Abrasive soil – Consider having points hard surfaced by local welder.
3. Operating too fast – Reduce forward speed.

R-130 SINGLE SHANK RIPPER  
PARTS DRAWING

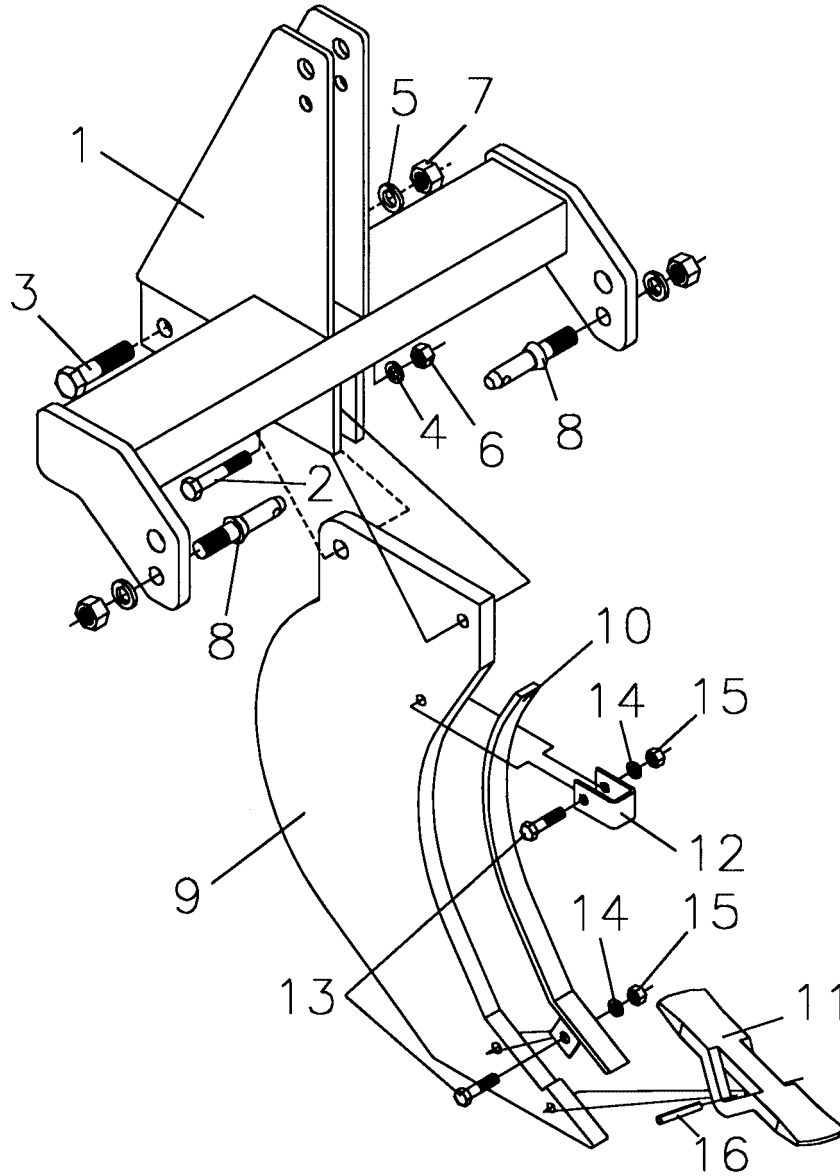

R-130 SINGLE SHANK RIPPER  
PARTS LIST

REF NO.	PART NO.	DESCRIPTION	NO. REQ.
1	800135	Main Frame Weldment (R-130)	1
2	2503049	Bolt 5/8"-11NC x 3 1/2" Hex Head Gr.2 (Shearbolt)	1
3	2503082	Bolt 7/8"-9NC x 3 1/2" Hex Head	1
4	2502007	Washer 5/8" Springlock	1
5	2502005	Washer 7/8" Springlock	1
6	2500013	Nut 5/8"-11NC Full Hex	1
7	2500015	Nut 7/8"-9NC Full Hex	1
8	590108	Pull Pin - Cat. I (AK-578)	2
9	800124	30" Shank (R-Series)	1
10	800130	Wear Strip Weldment	1
11	800126	Reversible Point (R-Series)	1
12	380180	Wear Strip Clip	1
13	2503007	Bolt 1/2"-13NC x 2" Hex Head	2
14	2502002	Washer 1/2" Springlock	2
15	2500003	Nut 1/2"-13NC Full Hex	2
16	2504195	Roll Pin 1/2" x 2 1/2"	1

# ⚠ SAFETY PRECAUTIONS ⚠

**MOST ACCIDENTS OCCUR BECAUSE OF NEGLIGENCE OR CARELESSNESS.  
AVOID NEEDLESS ACCIDENTS BY FOLLOWING ALL OF THE SAFETY PRECAUTIONS LISTED BELOW.**

- Machinery should be operated only by those who are responsible and are authorized to do so.
- Stop the engine, lower all equipment, lock the brakes, and remove the ignition key before dismounting from the tractor.
- Never stand between tractor and implement while tractor is being backed to hitch.
- Loose fitting clothing should not be worn, to avoid catching on various parts.
- Detach implement in area where children normally do not play.
- When performing adjustments or maintenance on an implement, first lower it to the ground or block it securely at a workable height.
- Only a qualified operator should be permitted on tractor when in operation; no riders allowed.
- Make certain everyone is in the clear before starting tractor or raising or lowering equipment.
- Operate the tractor and implement only while seated in the driver's seat.
- Reduce speed when transporting mounted implements to avoid bouncing and momentary loss of steering control.
- A heavy load can cause instability of the tractor. Use extreme care during road travel. Slow down on turns and watch out for bumps. Tractor may need front counterweights to counter-balance the weight of the implement.
- Reduce speed on hillsides or curves so there is no danger of tipping.
- Avoid driving too close to the edge of ditches or creeks.
- Do not transport implement on public roads without reflectors and slow moving vehicle emblem in daylight and with approved warning lights at night and other periods of poor visibility.
- Due to the width of some implements, use extra caution on highways, farm roads, and when approaching gates.
- Always be sure the implement is in the proper position for transport.
- Keep alert and watch the front as well as the rear when working with the implement.

## OWNER'S/ OPERATOR'S MANUAL

**MODEL NO.  
R-130**

### **WHEN ORDERING REPAIR PARTS, ALWAYS GIVE THE FOLLOWING INFORMATION:**

1. PART NUMBER
2. PART DESCRIPTION
3. MODEL NUMBER
4. NAME OF ITEM

APRIL 2002

***Please work, drive, play and live each day with  
care and concern for your safety and that of your  
family and fellow citizens.***

**MAKE EVERY DAY  
A HOLIDAY FROM ACCIDENTS**

## **Single Shank Subsoiler**

### **WORKSAVER LIMITED WARRANTY**

Worksaver warrants its implements, parts and accessories to be free from defects in materials and workmanship for a period of six (6) months from date of purchase. Upon written approval, Worksaver will repair or exchange without charge any part, which upon examination by Worksaver or its authorized agent, shall disclose to be defective.

This does not apply to (1) parts that have worn out in normal use, (2) parts broken because of improper assembly or operation by the customer, (3) parts accidentally damaged, (4) failure of parts traceable to improper care, (5) parts failing through use of implement for purposes other than those for which it was designed.

The obligations assumed by Worksaver and the limitations expressed herein are in lieu of all other warranties expressed or implied.

**WORKSAVER, INC.**

**P.O. BOX 100 LITCHFIELD, IL 62056-0100 (217) 324-5973**

**WEB: <http://www.worksaver.com> E-MAIL: [sales@worksaver.com](mailto:sales@worksaver.com)**