

OWNER'S/ OPERATOR'S MANUAL

MODEL NO.'s

SBX-4

SBX-5

SBX-6

SBX-7

CAUTION

For Safe Operation
Read Rules And
Instructions Carefully

SI NO LEEINGLES, PIDA AYUDA
A AIGUIEN QUE SI LO LEA
PARA QUE LE TRADUZCA LAS
MEDIDAS DE SEGURIDAD.

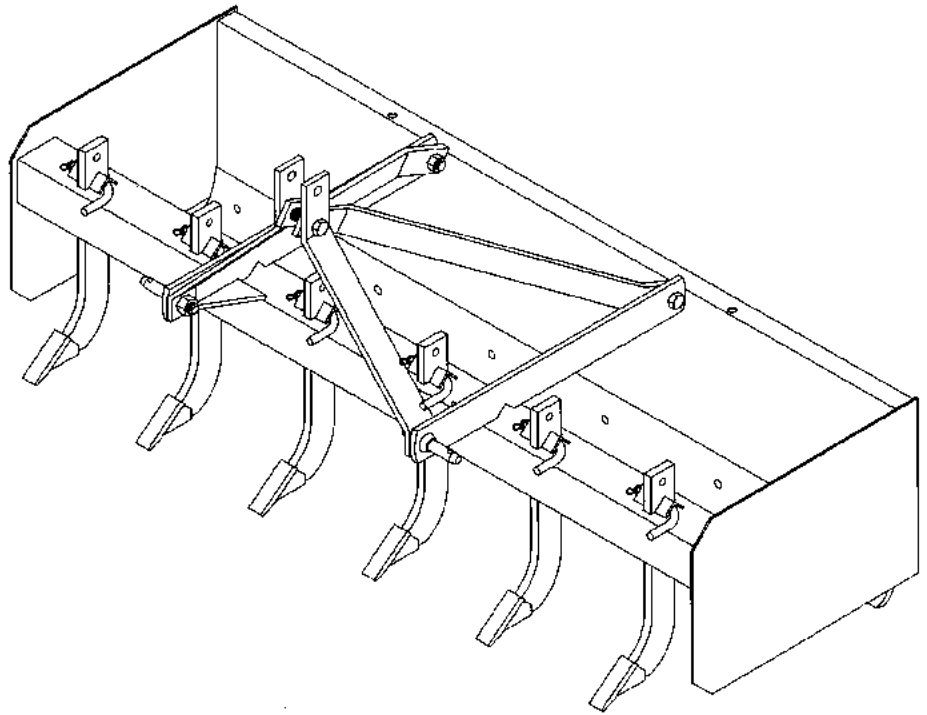

3 PT. BOX SCRAPER

Safety Instructions

Tractor Preparation

Operating Instructions

Assembly & Mounting

Maintenance

Repair Parts

CAUTION

**THE FOLLOWING SAFETY PRECAUTIONS SHOULD BE THOROUGHLY UNDERSTOOD
BEFORE ATTEMPTING TO BEGIN ASSEMBLING THIS MACHINE**

1. Select an area for assembly that is clean and free of any debris which might cause persons working on the assembly to trip.
2. Do not lift heavy parts or assemblies. Use crane, jack, tackle, fork trucks or other mechanical devices.
3. Preview the assembly instructions in your operator's manual before proceeding further.
4. If the assembly instructions call for parts or assemblies to be blocked up, use only blocking material that is in good condition and is capable of handling the weight of the assembly to be blocked. Also insure that the blocking material is on a clean, dry surface.
5. Never put hands, or any part of body, under blocked up assemblies if at all possible.
6. After completing assembly, thoroughly inspect the machine to be sure that all nuts, bolts, hydraulic fittings or any other fastened assemblies have been thoroughly tightened.
7. Before operating the machine, thoroughly read the operation section of your operator's manual.
8. Before operating, read the maintenance section of your operator's manual to be sure that any parts requiring lubrication, such as gearboxes, are full, to avoid any possible damage.
9. **Before operating equipment – If you have any questions regarding the proper assembly or operation, contact your dealer or representative.**

To the Owner/Operator/Dealer

All implements with moving parts are potentially hazardous. There is no substitute for a cautious, safe-minded operator who recognizes the potential hazards and follows reasonable safety practices. The manufacturer has designed this implement to be used with all its safety equipment properly attached to minimize the chance of accidents.

BEFORE YOU START!!

Read the safety messages on the implement and shown in your manual.
Observe the rules of safety and common sense!



THIS SYMBOL MEANS

- ATTENTION!
- BECOME ALERT!
- YOUR SAFETY IS INVOLVED!

THIS SAFETY ALERT SYMBOL IDENTIFIES IMPORTANT SAFETY WARNING MESSAGES. CAREFULLY READ EACH WARNING MESSAGE THAT FOLLOWS. FAILURE TO UNDERSTAND AND OBEY A SAFETY WARNING, OR RECOGNIZE A SAFETY HAZARD, COULD RESULT IN AN INJURY OR DEATH TO YOU OR OTHERS AROUND YOU. THE OPERATOR IS ULTIMATELY RESPONSIBLE FOR THE SAFETY OF HIMSELF, AS WELL AS OTHERS, IN THE OPERATING AREA OF THE TRACTOR AND ATTACHED EQUIPMENT.

UNDERSTAND SIGNAL WORDS

 **DANGER** Indicates an imminently hazardous situation that, if not avoided, WILL result in DEATH OR VERY SERIOUS INJURY.

 **WARNING** Indicates a imminently hazardous situation that, if not avoided, COULD result in DEATH OR SERIOUS INJURY.

 **CAUTION** Indicates a imminently hazardous situation that, if not avoided, MAY result in MINOR INJURY.

IMPORTANT Identifies special instructions or procedures that, if not strictly observed, could result in damage to, or destruction of the machine, attachments or the environment.

NOTE: *Identifies points of particular interest for more efficient and convenient operation or repair.*

If you have questions not answered in this manual or require additional copies or the manual is damaged, please contact your dealer or the manufacturer directly.

IMPORTANT SAFETY INFORMATION!

Working with equipment can lead to injuries. Read this manual, and the manual for your tractor, before assembly or operating, to acquaint yourself with the machines. It is the implement owner's responsibility, if this machine is used by any person other than yourself, is loaned or rented, to make certain that the operator, prior to operating:

1. Reads and understands the operator's manuals.
2. Is instructed in safe and proper use.

 The use of this equipment is subject to certain hazards which cannot be protected against by mechanical means or product design. All operators of this equipment must read and understand this entire manual, paying particular attention to safety and operating instructions, prior to using. If there is something in this manual you do not understand, ask your supervisor, or your dealer, to explain it to you.

SAFETY INSTRUCTIONS (continued)



PREPARATION



Personal protection equipment including hard hat, safety glasses, safety shoes, and gloves are recommended during assembly, installation, operation, adjustment, maintaining, repairing, removal, or moving the implement. Do not allow long hair, loose fitting clothing or jewelry to be around moving parts.



This equipment is dangerous to children and persons unfamiliar with its operation. The operator should be a responsible adult familiar with farm machinery and trained in this equipment's operations. **Do not allow persons to operate or assemble this unit until they have read this manual and have developed a thorough understanding of the safety precautions and of how it works.**



Tractor must be equipped with ROPS or ROPS cab and seat belt. Keep seat belt securely fastened. Falling off tractor can result in death from being run over or crushed. Keep foldable ROPS system in "locked up" position at all times.



Never use alcoholic beverages or drugs which can hinder alertness or coordination while operating this equipment. Consult your doctor about operating this machine while taking prescription or over the counter medications.



OPERATIONAL SAFETY



Start tractor only when properly seated in the tractor seat. Starting a tractor in gear can result in injury or death. Do not mount or dismount the tractor while the tractor is moving. Mount or dismount the tractor only when the tractor and all moving parts are completely stopped.



Operate the tractor and/or implement controls only while properly seated in the tractor seat with the seat belt securely fastened around you. Inadvertent movement of the tractor or implement may cause serious injury or death.



Never leave the tractor and implement unattended while the implement is in the lifted position. Accidental operation of lifting lever or a hydraulic failure may cause sudden drop of unit with injury or death by crushing.



Know your controls and how to stop tractor, engine, and implement quickly in an emergency. Read this manual and the one provided with your tractor.



Do not allow children or others to ride on the tractor with an operator. Riders are subject to injury such as being struck by foreign objects or being thrown off. Riders obstruct the operator's view resulting in unsafe operation. **Never allow anyone to ride on the implement!**

















Never allow children to play on or around tractor or implement. Children can slip or fall off the equipment and be injured or killed. Inadvertent contact with controls can cause the implement to shift or fall crushing themselves or others.



Use stabilizer bars, adjustable sway chains, or sway blocks on your tractor lift arms to keep the implement from swinging side to side. Adjust as tightly as practical for best performance.

SAFETY INSTRUCTIONS (continued)

-  Always use two people to handle heavy, unwieldy components during assembly, installation, removal, or moving the implement.
-  Never place any part of your body where it would be in danger if movement should occur during assembly, installation, operation, maintaining, repairing, removal, or moving the implement.
-  Never place yourself between the tractor and implement while implement is in operation.
-  Do not work under a raised implement unless it is securely blocked or held in position. Do not depend on the tractor hydraulic system to hold the implement in place.
-  A heavy load can cause instability of the tractor. Use extreme care during travel. Slow down on turns and watch out for bumps. The tractor may need front counter-weights to counter-balance the weight of the implement.
-  Do not allow others to ride on the tractor with an operator. Riders are subject to injury such as being struck by foreign objects or being thrown off. Riders obstruct the operator's view resulting in unsafe operation. **Never allow anyone to ride on the implement!**
-  Before you operate the implement, check over all pins, bolts and connections to be sure all are securely in place. Replace any damaged or worn parts immediately.
-  Never allow children to operate or be around equipment.
-  Avoid excessive speed during operation. Use care when working on slopes.
-  Make adjustments only when the box scraper is attached to the tractor.
-  When using the box scraper in a reverse position, use extra care. **Do not ram box scraper** into piles of dirt. Tractor lift arms and the box scraper are not built to take high impact loads in this position. **Ramming** backwards can also dislodge operator from seat and/or tractor controls, resulting in possible serious injury or death.
-  Always ease the tractor into the load. It may be necessary to reposition and take less "bite" on the material to move it safely.
-  Watch for and avoid hidden obstructions, i.e., buried pipes, rocks, concrete piers, uneven concrete slabs, stumps, etc., when operating.
-  Never operate the tractor and implement under trees with low hanging limbs. Operators can be knocked off the tractor and then run over.
-  Keep alert and watch the front as well as the rear when working with the box scraper.

SAFETY INSTRUCTIONS (continued)



When maneuvering close to buildings or passing through narrow areas, be sure to allow sufficient clearance for the box scraper.



Do not operate close to ditches or creeks. Slow down when operating over rough ground.



When removing, changing the shanks, be sure that your feet are never under the box scraper.



Use extreme caution when backfilling deep holes or trenches.



Be careful to avoid catching the box scraper on stumps or other immovable objects.



Keep all persons away from operator control area while performing adjustments, service, or maintenance.



Always stop the tractor, set brake, shut off the tractor engine, remove the ignition key, lower implement to the ground before dismounting tractor. Never leave equipment unattended with the tractor running. Park in level area.



TRANSPORT SAFETY



Comply with state and local laws governing highway safety and movement of farm machinery on public roads.



When driving the tractor and equipment on the road or highway under 20 mph (32 kph) at night or during the day, use flashing amber warning lights and a slow moving vehicle (SMV) identification emblem.



Be aware of the operating conditions. Do not operate the tractor with weak or faulty brakes. When operating down a hill or on wet or rain slick roads, the braking distance increases; use extreme care and reduce your speed in these conditions. When operating in traffic, always use the tractor's flashing warning lights and reduce your speed. Be aware of traffic around you and watch out for the other guy.



Always be sure the implement is in the proper raised position and the PTO is turned off for transport.



STORAGE SAFETY



Following operation, or when unhooking, stop the tractor, set the brakes, disengage the PTO, shut off the engine and remove the ignition keys.



Use extreme care to keep feet and hands from under the unit and clear of any pinch points. Never stand or allow another person to stand between a running tractor and the unit when disconnecting the implement from the tractor 3-point hitch.



Store the unit in an area away from human activity. Do not permit children to play on or around the stored unit.



Make sure all parked machines are on a hard, level surface and engage all safety devices. Storage location should be level and solid to make connecting and unconnecting to power unit easy.

SAFETY SIGNS

⚠ WARNING

TO AVOID SERIOUS INJURY OR DEATH:

- Read Operator's Manual before operating, servicing, or repairing equipment. Follow all safety rules and instructions. (Manuals are available from your selling dealer.)
- Never allow riders.
- Keep bystanders away from equipment during operation.
- Operate from tractor seat only.
- Keep all shields in place and in good condition.
- Lower equipment to ground, stop engine, remove key and set brake before dismounting tractor.
- Never allow children or untrained persons to operate equipment.

FAILURE TO FOLLOW THESE INSTRUCTIONS CAN RESULT IN INJURY OR DEATH.

101221

BE CAREFUL!

Use a clean, damp cloth to clean safety decals. Avoid spraying to close to decals when using a pressure washer; high-pressure water can enter through very small scratches or under edges of decals causing them to peel or come off.

⚠ WARNING



CRUSHING AND PINCHING HAZARD

- Be extremely careful handling various parts of the machine. They are heavy and hands, fingers, feet, and other body parts could be crushed or pinched between tractor and implement.
- Operate tractor controls from tractor seat only.
- Do not stand between tractor and implement when tractor is in gear.
- Make sure parking brake is engaged before going between tractor and implement.
- Stand clear of machine while in operation or when it is being raised or lowered.

FAILURE TO FOLLOW THESE INSTRUCTIONS COULD RESULT IN SERIOUS INJURY OR DEATH.

101212

⚠ WARNING

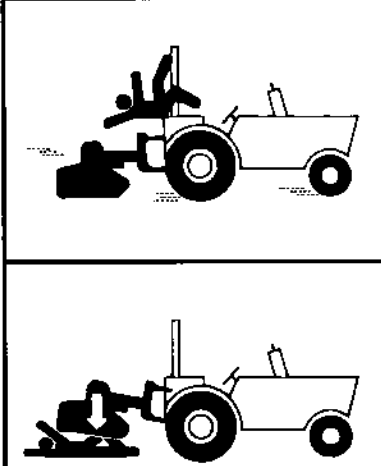

FALLING OFF CAN RESULT IN BEING RUN OVER.

- Tractor must be equipped with ROPS (or ROPS CAB) and seat belt. Keep foldable ROPS systems in "locked up" position at all times.
- Buckle up! Keep seat belt securely fastened.
- Allow no riders.

RAISED IMPLEMENT CAN DROP AND CRUSH.

- Never go underneath raised implement which can drop from equipment or tractor 3-point hitch hydraulic leak down, hydraulic system failures, movement of control levers or mechanical linkage failures.
- Service work does not require going underneath implement. Read manual instructions.

FALLING OFF OR GOING UNDERNEATH IMPLEMENT CAN RESULT IN SERIOUS INJURY OR DEATH.

101220

REMEMBER: If Safety Signs have been damaged, removed, become illegible or parts replaced without Signs, new Safety Signs must be applied. New Safety Signs are available from your authorized distributor or factory.

INSTRUCTIONS

TRACTOR REQUIREMENTS AND PREPARATION

The SBX Series Box Scrapers will fit most Category I Tractors equipped with a standard 3-point hitch.

Check the tractor's 3-point hydraulic lift system. It should operate up and down smoothly and hold its position when set. Refer to your tractor owner's manual or dealer for any adjustments necessary to put the 3-point hydraulic lift system in good working order. (I&T shop manuals will list most specifications and adjustment instructions – available from most farm equipment dealers.)

Tractor should be equipped with stabilizer bars, adjustable sway chains, or sway blocks to keep the implement from swinging side to side.

Smaller size tractors may need front counter weights to counter-balance the weight of the implement.

Tractor must be equipped with ROPS or ROPS cab and seat belt. Keep seat belt securely fastened. Falling off tractor can result in death from being run over or crushed. Keep foldable ROPS system in "locked up" position at all times. Contact your local dealer for a ROPS for your tractor.



Be sure your tractor is in good condition. Read all the safety precautions and make sure all tractor operators are familiar with the safety rules of operation.

ASSEMBLY AND MOUNTING

1. Attach the upper 3-point A-frame members, to the lower 3-point hitch lugs as shown on page 5, with hardware as indicated. **DO NOT** tighten hardware until all parts are in place. Align the A-frame top link and lower hitch holes in order to allow your hitch pins to pass through them. A-frame should be positioned square to the box scraper frame when tightening hardware.
2. Before inserting shanks, attach box scraper to tractor 3-point hitch using top 3-point hitch pin and linch pins furnished by customer, or raise up front of box scraper and support with blocks.

Shank Setting & Adjustments

Remove shanks from shipping position and insert into shank tube from the bottom side with tips pointing towards the tractor. Position shank to the desired depth and secure with shank lock pin (#14) and hair pin cotter (#15).

Shank settings from bottom of end plate to tip of shanks are as follows:



Top Hole - 3⁵/₈" Below
Second Hole - 2¹/₈" Below
Third Hole - 5¹/₈" Below

Connecting Box Blade to Tractor

The box blade is compatible with Category 1, 3 point tractors equipped with side swing-type lower lift arms.

1. To avoid interference with the box blade, adjust tractor swinging drawbar to the shortest and highest position.
2. Attach the tractor's lower lift arms to the box blade and secure in place with Category 1 mounting pin (1) and lock pin (2).
3. If box blade is going to be used in reverse, tractor must be equipped with stabilizer bars, adjustable sway chains, or sway blocks to keep the implement from swinging side to side.
4. Attach the tractor's top link to the top of the box blade's mast and secure with the top link pin and retaining pin supplied with the top link.

Adjusting Top Link

The box blade is leveled front to rear by adjusting the length of the tractor's top link.

- Shortening the top link will deepen the scarifier tooth penetration.
- Lengthening the top link will provide better scraping and leveling action.

Experience will allow the operator to determine the best setting for the application being done.

OPERATING INSTRUCTIONS

Safety is a primary concern in the design and manufacture of our products. Unfortunately, our efforts to provide safe equipment can be wiped out by an operator's single careless act.

In addition to the design and configuration of equipment, hazard control and accident prevention are dependent upon the awareness, concern, judgement, and proper training of personnel involved in the operation, transport, maintenance and storage of equipment.

It has been said "The best safety device is an informed, careful operator." We ask you to be that kind of operator.

The operator is responsible for the safe operation of this equipment. The operator must be properly trained. Operators should be familiar with the equipment, the tractor, and all safety practices before starting operation. Read the safety rules and safety decals on pages 1 through page 4.

The box blades are designed for a wide range of applications: scarifying, scraping, leveling, grading, and backfilling.



WARNING

■ **Tractor must be equipped with ROPS or ROPS cab and seat belt. Keep seat belt securely fastened. Falling off tractor can result in death from being run over or crushed. Keep foldable ROPS systems in "locked up" position at all times.**

■ **Never allow children or untrained persons to operate equipment.**

■ **Keep bystanders away from equipment.**



CAUTION

■ **Stop tractor and implement immediately upon striking an obstruction. Turn off engine, remove key, inspect, and repair any damage before resuming operation.**

■ **Always wear relatively tight and belted clothing to avoid entanglement in moving parts. Wear sturdy, rough-soled work shoes and protective equipment for eyes, hair, hands, hearing, and head.**



WARNING

■ **When using the box blade in a reverse position use extra care – DO NOT RAM BOX BLADE into obstructions (including hard packed snow and dirt piles)! Tractor lift arms and the box blade are not built to take high impact loads in this position. RAMMING backwards can also dislodge operator from seat and/or tractor controls, resulting in possible serious injury or death.**

■ **NEVER GO UNDERNEATH EQUIPMENT. Never place any part of the body underneath equipment or between moveable parts even when the engine has been turned off. Hydraulic system leak down, hydraulic system failures, mechanical failures, or movement of control levers can cause equipment to drop or rotate unexpectedly and cause severe injury or death.**

- **Service work does not require going underneath.**
- **Read Manual for service instructions or have someone read it to you.**

Scarifying

1. Place the scarifier shanks in position with the points facing toward the tractor.
2. Lock into position with the pins provided. The lower shank position provides the greatest ground penetration.
3. Lower the box blade and drive the tractor ahead to begin the scarifying operation.
4. Adjust the depth of the scarifier by using the middle or top hole in the shank and by tilting the unit with the tractor top link. Shortening the top link will provide deeper and more aggressive operation.



**SAFETY . . .
YOU CAN LIVE WITH IT!**

OPERATION INSTRUCTIONS (continued)

OPERATING TIPS (continued)

Scraping

1. Raise or remove the scarifier shanks. Lower the box blade and drive forward to move material.
2. Adjust the depth of the box blade by tilting the unit with the tractor top link.

Shortening the top link when scraping will transfer more weight on the front of the box blade and will raise the cutting edge to provide a more shallow cut.

NOTE: When the top link is adjusted properly, the bowl of the box blade should fill easily and material can be pulled to a desired location.

3. To change the side to side level of the box blade, shorten or lengthen the tractor lift arm tilt link to provide the correct slope.
4. Spread material by gradually raising the box blade as the tractor moves forward.

NOTE: Top link adjustment for loose or previously scarified material will differ from adjustment required for hard or compacted material.

NOTE: Shanks can be stored upside down in main tube slots. Pin in position.

Backfilling

1. Raise or remove scarifier shanks.
2. Tractor must be equipped with stabilizer bars, adjustable sway chains, or sway blocks to keep the box blade from swinging side to side.
3. Lower the box blade to the ground and back up into the fill material.
4. Shorten the top link to raise the cutting edge and control how much the box blade digs in.

NOTE: Shanks can be stored upside down in main tube slots. Pin in position.

Leveling

1. Raise or remove scarifier shanks.
2. Shorten the top link so the cutting edge clears the ground.
3. Drive forward with the box blade in this position and loose material will be leveled.



WARNING

- Do not operate on steep slopes.
- Do not stop, start, or change directions suddenly on slopes.
- Use extreme care and reduce ground speed on slopes and rough terrain.
- Watch for hidden hazards on the terrain during operation.

STORAGE

At the end of the working season or when the box scraper will not be used for a long period, it is good practice to clean off any dirt or grease that may have accumulated on the scraper and any of the moving parts.

Inspect the scraper for loose, damaged or worn parts and adjust or replace if needed.

- Block equipment securely for storage.
- Keep children, bystanders, and livestock away from storage area.
- Storage location should be level and solid to make hitching and unhitching easy.

OWNER SERVICE

The information in this section is written for operators who possess basic mechanical skills. If you need help, your dealer has trained service technicians available. For your protection, read and follow the safety information in this manual.



WARNING

■ **NEVER GO UNDERNEATH EQUIPMENT.** Never place any part of the body underneath equipment or between moveable parts even when the engine has been turned off. Hydraulic system leak down, hydraulic system failures, mechanical failures, or movement of control levers can cause equipment to drop or rotate unexpectedly and cause severe injury or death.

- Service work does not require going underneath.
- Read Manual for service instructions or have service performed by a qualified dealer.

■ **Keep all persons away from operator control area while performing adjustments, service, or maintenance.**

■ **Before dismounting power unit or performing any service or maintenance, follow these steps: disengage power to equipment, lower the 3 point hitch and all raised components to the ground, operate valve levers to release any hydraulic pressure, set parking brake, stop engine, remove key, and unfasten seat belt.**

Blocking Up Box Blade

NOTE: To service the box blade when attached to the tractor, it must be blocked up off the ground.

1. Place two 6" x 6" (15 x 15 cm) blocks under each side frame of the box blade.
2. Lower the box blade to rest securely on the blocks.
3. Do not block the machine any higher than needed for removing the shanks or cutting edges.

Removing or Adjusting Scarifier Shanks

Scarifier shanks have three positions in the box blade. They may be removed if scarifying action is not needed.

1. Block up machine by placing two 6" x 6" (15 x 15 cm) blocks under each side-frame of the box blade.
2. Lower the box blade to rest securely on the blocks.

NOTE: Do not block the machine any higher than necessary to remove the shanks or cutting edges.

3. Remove the hairpin clip and hold the lower part of the shank while removing the shank position pin.
4. Raise or lower the shank as desired and reinstall the shank position pin. Secure with the hairpin clip.
5. If removing the shanks, place them upside down in the slot and install the shank position pin to hold the shank. Secure with the hairpin clip. This keeps the shanks with the box blade and ready for use when needed.

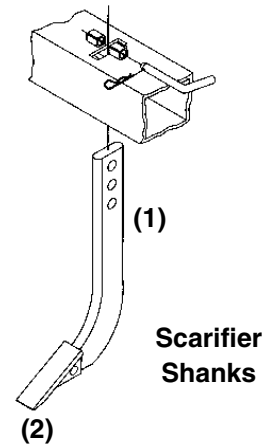

Replacing Scarifier Tooth

1. Remove scarifier shank from the scarifier bar.
2. Remove the worn tooth by driving a chisel between the shank (1) and tooth (2). Some teeth have a small weld holding the tooth to the shank. This weld must be cut.
3. Install the replacement tooth and use a welder to weld in place. One weld about 1/2" long each side will suffice.
4. Reinstall the shank in the scarifier bar.

OWNER SERVICE (continued)

Replacing Cutting Edge

All box blade models use two 1/2" x 6" (12.7 x 152 mm) cutting edges. They are interchangeable and reversible.

To service the box blade when attached to the tractor, it must be blocked up off the ground.

1. Place two 6" x 6" (15 x 15 cm) blocks under each side-frame of the box blade.
2. Lower the box blade to rest securely on the blocks.

NOTE: Do not block the machine any higher than necessary to remove the shanks or cutting edges.

3. Refer to parts drawing, page 10. Remove the lock nuts (5) and plow bolts (3) from blade. Turn cutting edge over and use new edge, or replace it if both edges have been used.
4. Attach cutting edge to box blade and secure with plow bolts and hex nuts previously removed.
5. Torque plow bolts to specifications.

SPECIFICATIONS

SBX SERIES FIXED BAR BOX SCRAPERS

MODEL/SERIES	SBX - 4	SBX - 5	SBX - 6	SBX - 7
WORKING WIDTH	48"	60"	72"	84"
HEIGHT OF MOLDBOARD	----- 16.5 inches -----			
DEPTH OF BUCKET	----- 21.5 inches -----			
OVERALL LENGTH	----- 26 inches -----			
TOTAL HEIGHT	----- 34 inches -----			
WEIGHT (POUNDS)	298	376	454	5242
NUMBER OF SHANKS	3	4	5	6
MAXIMUM H.P. RATING	30	35	40	50
LOWER HITCH	Bolted Pin	Bolted Pin	Bolted Pin	Clevis

BOX SCRAPER PARTS LIST

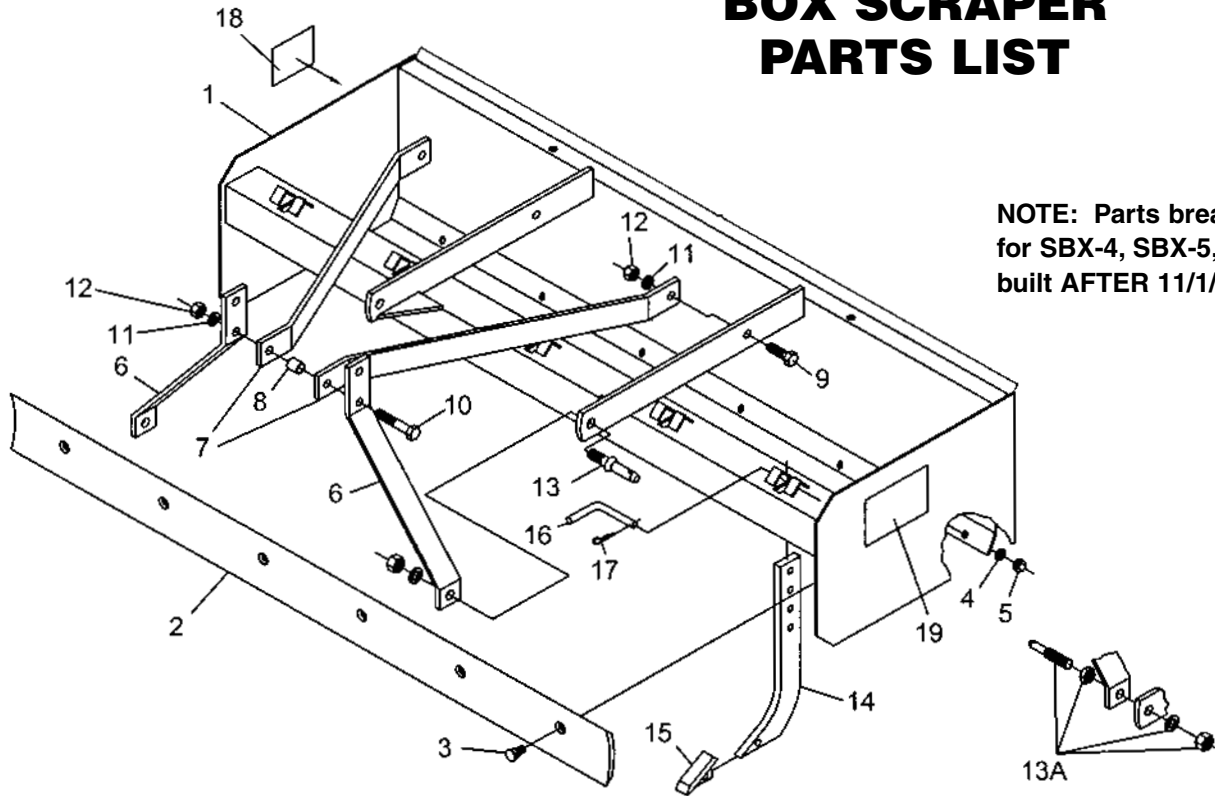

NOTE: Parts breakdown for SBX-4, SBX-5, SBX-6 built AFTER 11/1/2009.

Ref. No.	Part No.	Description	No. Req'd.
1	343211	Main Frame Weldment (SBX-4)	1
	343206	Main Frame Weldment (SBX-5)	1
	343201	Main Frame Weldment (SBX-6)	1
2	343223	Cutting Edge (SBX-4)	2
	343222	Cutting Edge (SBX-5)	2
	343221	Cutting Edge (SBX-6)	2
3	2503045	Bolt 5/8"-11NC x 1 1/2" Plow Head	Var.
4	2502007	Washer 5/8" Springlock	Var.
5	2500013	Nut 5/8"-11NC Full Hex	Var.
6	343208	Strap, Toplink 1/2" x 2 1/2"	2
7	343209	Strap, Tie 1/2" x 2 1/2"	2
8	343058	Spacer, Toplink	1
9	2503002	Bolt 3/4"-10NC x 2" Hex Head Gr. 2	2
10	2503033	Bolt 3/4"-10NC x 5" Hex Head Gr. 2	1
11	2502001	Washer 3/4" Springlock	3
12	2500002	Nut 3/4"-10NC Full Hex	3
13	590108	Draw Pin, Cat. I (AK-578)	2
13A	590330	Draw Pin, Cat. 0 (Optional - SBX-4 only)	2
14	341334	Shank, Scarifier w/Tip (Ref. #13)	Var.
15	343064	Replaceable Wear Tip	Var.
16	343180	Pin, Lock 1/2" x 3"	Var.
17	590187	Hair Clip Pin (AK-2704)	Var.
18	101128	Safety Sign - Caution (Avoid Injury)	1
19	101151	Safety Sign - Caution (Safe Practices)	1

SBX-7 BOX SCRAPER PARTS LIST

NOTE: Parts breakdown
for SBX-7 built AFTER
2/2011.

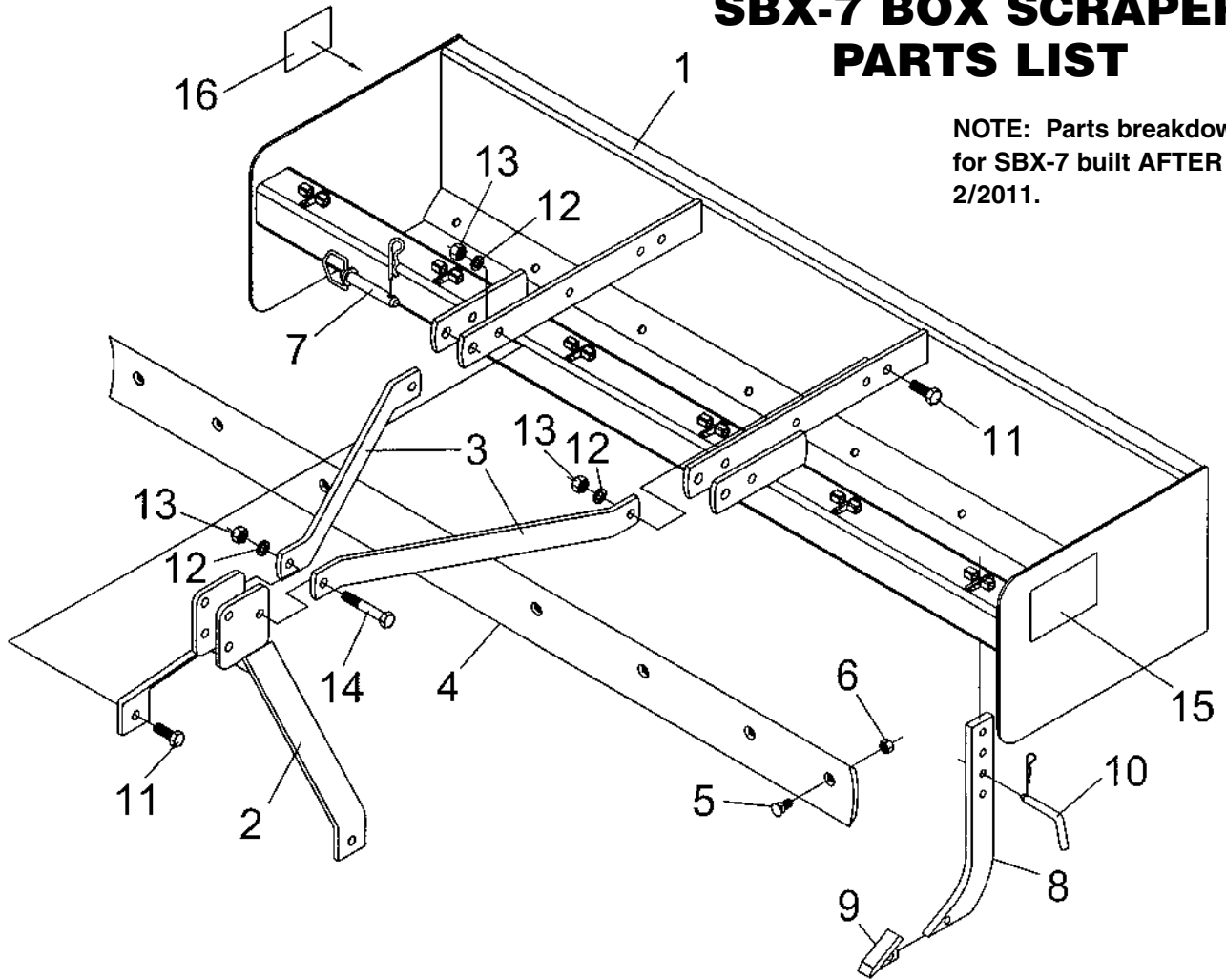

Ref. No.	Part No.	Description	No. Req'd.
1	343225	Main Frame Weldment (SBX-7)	1
2	343235	A-Frame Weldment	1
3	343209	Strap, Brace	2
4	346731	Cutting Edge 83 1/2"	2
5	2503045	Bolt 5/8"-11NC x 1 1/2" Plow Head	16
6	2500094	Nut 5/8"-11NC Toplock Hex Gr. 5	16
7	343195	Pin 7/8" x 4 1/4" w/Lock Pin	2
8	341334	Shank, Scarifier w/Tip (Ref. #9)	6
9	343064	Replaceable Wear Tip	6
10	343180	Shift Pin w/Clip 1/2" x 3"	6
11	2503002	Bolt 3/4"-10NC x 2" Hex Head Gr. 2	4
12	2502001	Washer 3/4" Springlock	6
13	2500002	Nut 3/4"-10NC Full Hex	6
14	2503121	Bolt 3/4"-10NC x 4 1/2" Hex Head Gr. 2	2
15	101128	Safety Sign - Caution (Avoid Injury)	1
16	101151	Safety Sign - Caution (Safe Practices)	1

SAFETY REQUIREMENTS

AVOID ACCIDENTS BY FOLLOWING ALL OF THE SAFETY REQUIREMENTS LISTED BELOW.

- Machinery should be operated only by those who are responsible and are authorized to do so.
- Stop the engine, lower all equipment, lock the brakes, and remove the ignition key before dismounting from the tractor.
- Never stand between tractor and implement while tractor is being backed to hitch.
- Loose fitting clothing should not be worn, to avoid catching on various parts.
- Detach implement in area where children normally do not play.
- When performing adjustments or maintenance on an implement, first lower it to the ground or block it securely at a workable height.
- Only a qualified operator should be permitted on tractor when in operation; no riders allowed.
- Make certain everyone is in the clear before starting tractor or raising or lowering equipment.
- Operate the tractor and implement only while seated in the driver's seat.
- Reduce speed when transporting mounted implements to avoid bouncing and momentary loss of steering control.
- A heavy load can cause instability of the tractor. Use extreme care during road travel. Slow down on turns and watch out for bumps. Tractor may need front counterweights to counter-balance the weight of the implement.
- Reduce speed on hillsides or curves so there is no danger of tipping.
- Avoid driving too close to the edge of ditches or creeks.
- Do not transport implement on public roads without reflectors and slow moving vehicle emblem in daylight and with approved warning lights at night and other periods of poor visibility.
- Due to the width of some implements, use extra caution on highways, farm roads, and when approaching gates.
- Always be sure the implement is in the proper position for transport.
- Keep alert and watch the front as well as the rear when working with the implement.

OWNER'S/ OPERATOR'S MANUAL

MODEL NO.'s

SBX-4

SBX-5

SBX-6

SBX-7

WHEN ORDERING REPAIR PARTS, ALWAYS GIVE THE FOLLOWING INFORMATION:

1. PART NUMBER
2. PART DESCRIPTION
3. MODEL NUMBER
4. NAME OF ITEM

FEBRUARY 2013

STATEMENT OF POLICY

It is the policy of Worksaver to improve its products where it is possible and practical to do so. Worksaver reserves the right to make changes or improvements in design and construction at any time, without incurring the obligation to make these changes on previously manufactured units.

3 PT. BOX SCRAPER

For Cat. 0 and I 3 Pt. Hitch Tractors
up to 50 H.P.

LIMITED WARRANTY

Worksaver warrants its implements, parts and accessories to be free from defects in materials and workmanship for a period of six (6) months from date of purchase. Upon written approval, Worksaver will repair or exchange without charge any part, which upon examination by Worksaver or its authorized agent, shall disclose to be defective.

This does not apply to (1) parts that have worn out in normal use, (2) parts broken because of improper assembly or operation by the customer, (3) parts accidentally damaged, (4) failure of parts traceable to improper care, (5) parts failing through use of implement for purposes other than those for which it was designed.

The obligations assumed by Worksaver and the limitations expressed herein are in lieu of all other warranties expressed or implied.

WORKSAVER, INC.

P.O. BOX 100 LITCHFIELD, IL 62056-0100 (217) 324-5973
WEB: <http://www.worksaver.com> E-MAIL: sales@worksaver.com