

OWNER'S/ OPERATOR'S MANUAL

MODEL NO.'s

BF-1000

BF-2000

BF-4000

CAUTION

For Safe Operation
Read Rules And
Instructions Carefully

SINO LEEINGLES, PIDA AYUDA
A AIGUIEN QUE SI LO LEA
PARA QUE LE TRADUZCA LAS
MEDIDAS DE SEGURIDAD.

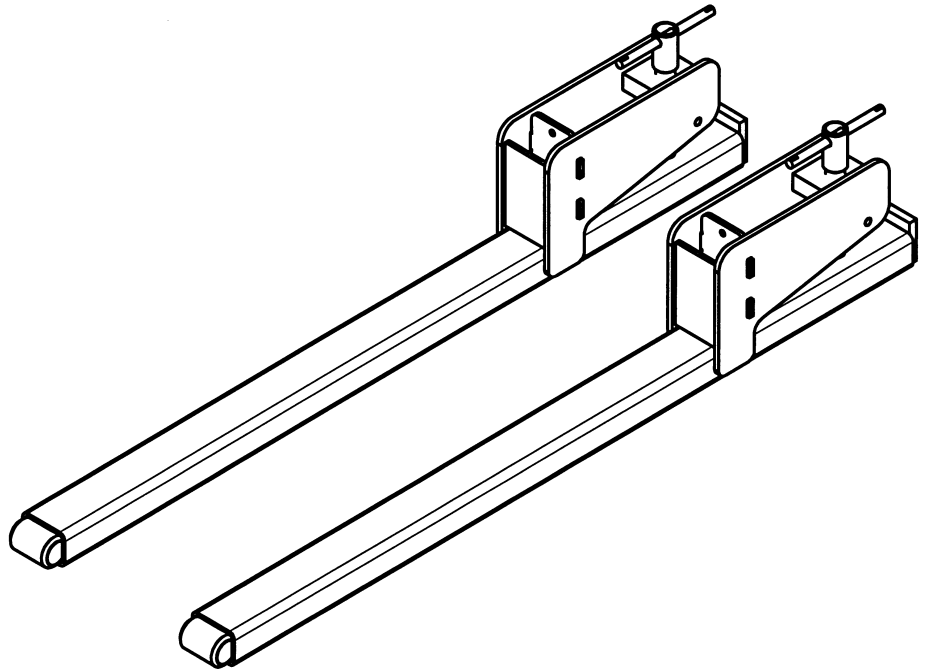

CLAMP-ON BUCKET PALLET FORKS

Safety Instructions

Tractor Preparation

Operating Instructions

Assembly & Mounting

Maintenance

Repair Parts

CAUTION

THE FOLLOWING SAFETY PRECAUTIONS SHOULD BE THOROUGHLY UNDERSTOOD BEFORE ATTEMPTING TO BEGIN ASSEMBLING THIS MACHINE

1. Select an area for assembly that is clean and free of any debris which might cause persons working on the assembly to trip.
2. Do not lift heavy parts or assemblies. Use crane, jack, tackle, fork trucks or other mechanical devices.
3. Preview the assembly instructions in your operator's manual before proceeding further.
4. If the assembly instructions call for parts or assemblies to be blocked up, use only blocking material that is in good condition and is capable of handling the weight of the assembly to be blocked. Also insure that the blocking material is on a clean, dry surface.
5. Never put hands, or any part of body, under blocked up assemblies if at all possible.
6. After completing assembly, thoroughly inspect the machine to be sure that all nuts, bolts, hydraulic fittings or any other fastened assemblies have been thoroughly tightened.
7. Before operating the machine, thoroughly read the operation section of your operator's manual.
8. Before operating, read the maintenance section of your operator's manual to be sure that any parts requiring lubrication, such as gearboxes, are full, to avoid any possible damage.
9. **Before operating equipment – If you have any questions regarding the proper assembly or operation, contact your dealer or representative.**

TABLE OF CONTENTS

SAFETY INFORMATION	3
SAFETY SIGNS	11
INSTRUCTIONS	12
OPERATING INSTRUCTIONS	14
TROUBLE-SHOOTING GUIDE	17
INSTRUCTIONS FOR UPRIGHT BACKSTOPS	18
PARTS	19

SINO LEEINGLES, PIDA AYUDA A AIGUIEN QUE SI LO LEA PARA QUE LE TRADUZCA LAS MEDIDAS DE SEGURIDAD.

STATEMENT OF POLICY

It is the policy of Worksaver, Inc. to improve its products where it is possible and practical to do so. Worksaver, Inc. reserves the right to make changes or improvements in design and construction at any time, without incurring the obligation to make these changes on previously manufactured units.

TO THE OWNER:

Read this manual before using your Clamp-on Bucket Pallet Forks. This manual is provided to give you the necessary operating and maintenance instructions for keeping your Clamp-on Bucket Pallet Forks in top operating condition. Please read this manual thoroughly. Understand what each control is for and how to use it. Observe all safety signs on the machine and noted throughout the manual for safe operation of implement. Keep this manual handy for ready reference.

Like all mechanical products, it will require cleaning and upkeep.

Use only genuine Worksaver, Inc. service parts. Substitute parts will void the warranty and may not meet standards required for safe and satisfactory operation. Record the model and serial number of your Clamp-on Bucket Pallet Forks here:

Model: _____ Serial Number: _____

RETAIL CUSTOMER'S RESPONSIBILITY

It is the Retail Customer and/or Operator's responsibility to read the Operator's Manual, to operate, lubricate, maintain, and store the product in accordance with all instructions and safety procedures. Failure of the operator to read the Operator's Manual is a misuse of this equipment.

It is the Retail Customer and/or Operator's responsibility to inspect the product and to have any part(s) repaired or replaced when continued operation would cause damage or excessive wear to other parts or cause a safety hazard.

It is the Retail Customer's responsibility to deliver the product to the authorized Worksaver Dealer, from whom he purchased it, for service or replacement of defective parts which are covered by warranty. Repairs to be submitted for warranty consideration must be made within forty-five (45) days of failure.

It is the Retail Customer's responsibility for any cost incurred by the Dealer for traveling to or hauling of the product for the purpose of performing a warranty obligation or inspection.

LIMITED WARRANTY

Worksaver warrants to the original purchaser of any new Clamp-on Bucket Pallet Forks (Models BF-1000, BF-2000, and BF-4000), that the equipment be free from defects in material and workmanship for a period of six (6) months for non-commercial, state, and municipalities. Use sixty (60) days for commercial use from date of retail sale.

Replacement or repair parts installed in the equipment covered by this warranty are warranted for sixty (60) days from the date of purchase of such part or to the expiration of the applicable new equipment warranty period, whichever occurs later.

Such parts shall be provided at no cost to the user during regular working hours. Worksaver reserves the right to inspect any equipment or parts which are claimed to have been defective in material or workmanship.

DISCLAIMER OF IMPLIED WARRANTIES & CONSEQUENTIAL DAMAGES

Worksaver's obligation under this warranty, to the extent allowed by law, is in lieu of all warranties, implied or expressed, including implied warranties of merchantability and fitness for a particular purpose and any liability for incidental and consequential damages with respect to the sale or use of the items warranted. Such incidental and consequential damages shall include but not be limited to: transportation charges other than normal freight charges; cost of installation other than cost approved by Worksaver; duty; taxes; charges for normal service or adjustments; loss of crops or any other loss of income; rental of substitute equipment, expenses due to loss, damage, detention or delay in the delivery of equipment or parts resulting from acts beyond the control of Worksaver.

THIS WARRANTY SHALL NOT APPLY:

1. If the unit has been subjected to misapplication, abuse, misuse, negligence, fire or other accident.
2. If parts not made or supplied by Worksaver have been used in connection with the unit, if, in sole judgement of Worksaver such use affects its performance, stability, or reliability.
3. If the unit has been altered or repaired outside of an authorized Worksaver dealership in a manner which, in the sole judgement of Worksaver affects its performance, stability or reliability.
4. To any damage to loader bucket caused by the use of the Clamp-on Bucket Pallet Forks. Owners and operators are responsible to see that the loader bucket used is in good condition and that the Clamp-on Bucket Pallet Forks are used correctly and safely.

NO EMPLOYEE OR REPRESENTATIVE OF WORKSAVER IS AUTHORIZED TO CHANGE THIS WARRANTY IN ANY WAY OR GRANT ANY OTHER WARRANTY UNLESS SUCH CHANGE IS MADE IN WRITING AND SIGNED BY WORKSAVER'S SERVICE MANAGER, POST OFFICE BOX 100, LITCHFIELD, ILLINOIS 62056-0100.

To the Owner/Operator/Dealer

All implements with moving parts are potentially hazardous. There is no substitute for a cautious, safe-minded operator who recognizes the potential hazards and follows reasonable safety practices. The manufacturer has designed this implement to be used with all its safety equipment properly attached to minimize the chance of accidents.

BEFORE YOU START!!

**Read the safety messages on the implement and shown in your manual.
Observe the rules of safety and common sense!**



THIS SYMBOL MEANS

- ATTENTION!
- BECOME ALERT!
- YOUR SAFETY IS INVOLVED!

THIS SAFETY ALERT SYMBOL IDENTIFIES IMPORTANT SAFETY WARNING MESSAGES. CAREFULLY READ EACH WARNING MESSAGE THAT FOLLOWS. FAILURE TO UNDERSTAND AND OBEY A SAFETY WARNING, OR RECOGNIZE A SAFETY HAZARD, COULD RESULT IN AN INJURY OR DEATH TO YOU OR OTHERS AROUND YOU. THE OPERATOR IS ULTIMATELY RESPONSIBLE FOR THE SAFETY OF HIMSELF, AS WELL AS OTHERS, IN THE OPERATING AREA OF THE SKID STEER UNIT OR TRACTOR AND ATTACHED EQUIPMENT.

UNDERSTAND SIGNAL WORDS

Note the use of the signal words **DANGER**, **WARNING** and **CAUTION** with the safety messages. The appropriate signal word for each has been selected using the following guidelines:

DANGER: Indicates an imminently hazardous situation that, if not avoided, will result in death or serious injury. This signal word is to be limited to the most extreme situations typically for machine components which, for functional purposes, cannot be guarded.

WARNING: Indicates a potentially hazardous situation that, if not avoided, could result in death or serious injury, and includes hazards that are exposed when guards are removed. It may also be used to alert against unsafe practices.

CAUTION: Indicates a potentially hazardous situation that, if not avoided, may result in minor or moderate injury. It may also be used to alert against unsafe practices.

If you have questions not answered in this manual or require additional copies or the manual is damaged, please contact your dealer or the manufacturer directly.

IMPORTANT SAFETY INFORMATION!

Working with unfamiliar equipment can lead to careless injuries. Read this manual and the manual for your tractor or skid steer, before assembly or operating, to acquaint yourself with the machines. It is the implement owner's responsibility, if this machine is used by any person other than yourself, is loaned or rented, to make certain that the operator, prior to operating:

1. Reads and understands the operator's manuals.
2. Is instructed in safe and proper use.



The use of this equipment is subject to certain hazards which cannot be protected against by mechanical means or product design. All operators of this equipment must read and understand this entire manual, paying particular attention to safety and operating instructions, prior to using. If there is something in this manual you do not understand, ask your supervisor, or your dealer, to explain it to you.

SAFETY INSTRUCTIONS (continued)





EQUIPMENT SAFETY GUIDELINES

 Safety of the operator is one of the main concerns in designing and developing a new piece of equipment. Designers and manufacturers build in as many safety features as possible. However, every year many accidents occur which could have been avoided by a few seconds of thought and a more careful approach to handling equipment. You, the operator, can avoid many accidents by observing the following precautions in this section. To avoid personal injury, study the following precautions and insist those working with you, or for you, follow them.

In order to provide a better view, certain photographs or illustrations in this manual may show an assembly with a safety shield removed. However, equipment should never be operated in this condition. Keep all shields in place. If shield removal becomes necessary for repairs, replace the shield prior to use.

 Replace any CAUTION, WARNING, DANGER or instruction safety sign that is not readable or is missing. Location of such safety signs is indicated in this booklet.

 Never use alcoholic beverages or drugs which can hinder alertness or coordination while operating this equipment. Consult your doctor about operating this machine while taking prescription medications.

 Review the safety instructions with all users annually.

 This equipment is dangerous to children and persons unfamiliar with its operation. The operator should be a responsible adult familiar with farm machinery and trained in this equipment's operations. **Do not allow persons to operate or assemble this unit until they have read this manual and have developed a thorough understanding of the safety precautions and of how it works.**

 To prevent injury or death, use a prime mover equipped with a Roll-Over Protective System (ROPS). Do not paint over, remove or deface any safety signs or warning signs on your equipment. Observe all safety signs and practice the instruction on them.

 Never exceed the limits of a piece of machinery. If its ability to do a job, or to do so safely, is in question - **DON'T TRY IT.**

 Do not modify the equipment in any way. Unauthorized modification may impair the function and/or safety and could affect the life of the equipment.

 In addition to the design and configuration of this implement, including Safety Signs and Safety Equipment, hazard control and accident prevention are dependent upon the awareness, concern, prudence, and proper training of personnel involved in the operation, transport, maintenance, and storage of the machine. Refer also to Safety Messages and Operation Instructions in each of the appropriate sections of the Tractor, Skid Steer, and Implement Manuals. Pay close attention to the Safety Signs affixed to the Tractor, Skid Steer, and the Implement.

SAFETY INSTRUCTIONS (continued)



SAFETY TRAINING



Safety is a primary concern in the design and manufacture of our products. Unfortunately, our efforts to provide safe equipment can be wiped out by a single careless act of an operator.

In addition to the design and configuration of equipment, hazard control and accident prevention are dependent upon the awareness, concern, prudence and proper training of personnel involved in the operation, transport, maintenance and storage of equipment.



It has been said, “The best safety device is an informed, careful operator.” We ask you to be that kind of an operator. It is the operator’s responsibility to read and understand ALL Safety and Operating instructions in the manual and to follow these. Accidents can be avoided.



Working with unfamiliar equipment can lead to careless injuries. Read this manual, and the manual for your tractor, before assembly or operating, to acquaint yourself with the machines. It is the equipment owner’s responsibility, if this machine is used by any person other than yourself, is loaned or rented, to make certain that the operator, prior to operating:

1. Reads and understands the operator’s manuals.
2. Is instructed in safe and proper use.



Train all new personnel and review instructions frequently with existing workers. A person who has not read and understood all operating and safety instructions is not qualified to operate the machine. An untrained operator exposes himself and bystanders to possible serious injury or death. Do not allow children to operate this machine.



STARTING AND STOPPING SAFETY



Be certain the power unit is in neutral or park position before starting engine.



Always shut off power unit and shift to “Park” or set brakes when leaving unit. Always lower bucket or attachment to ground, relieve all hydraulic pressure. Remove key when leaving equipment unattended. Park in level area.





Personal protection equipment including safety glasses, safety shoes, and gloves are recommended during assembly, installation, operation, adjustment, maintaining, repairing, removal, or moving the attachment.

SAFETY INSTRUCTIONS (continued)





OPERATIONAL SAFETY

-  The use of this equipment is subject to certain hazards which cannot be protected against by mechanical means or product design. All operators of this equipment must read and understand this entire manual, paying particular attention to safety and operating instructions, prior to using. If there is something in this manual you do not understand, ask your supervisor, or your dealer, to explain it to you.

-  Most accidents occur because of neglect or carelessness. Keep all helpers and bystanders fifty feet (50') from an operating power unit and attached equipment. Only properly trained people should operate this machine. It is recommended the prime mover be equipped with a Rollover Protection System (ROPS) and a seat belt that is used. Always stop the tractor, skid steer, or forklift, set brake, shut off the engine, remove the ignition key, and lower loader and attachment to the ground before dismounting. Never leave equipment unattended with the engine running.

-  Please remember it is important that you read and heed the safety signs on the front loader attachment and loader, and the safety rules set forth. Clean or replace all safety signs if they cannot be clearly read and understood. They are there for your safety as well as the safety of others. The safe use of this machine is strictly up to you, the operator.

-  Be sure power unit is in good condition. Read all the safety precautions and make sure all operators are familiar with the safety rules of operation.

-  Know your controls and how to stop the power unit and engine quickly in an emergency. **READ THIS MANUAL AND THE ONE PROVIDED WITH YOUR TRACTOR AND LOADER, SKID STEER OR FORKLIFT.**

-  Always use two people to handle heavy, unwieldy components during assembly, installation, removal, or moving the loader attachment.

-  Never place any part of your body where it would be in danger if movement should occur during assembly, installation, operation, maintaining, repairing, removal, or moving the implement.

-  The use of any loader attachment is **NOT** recommended on tractor with a tricycle wheel arrangement. Tricycle type tractors are unstable for front loader use.

-  A heavy load can cause instability in driving a power unit. Make sure the front or rear of the power unit is properly counter-balanced with weights. Always drive slowly – especially around turns. An unstable power unit could steer badly and possibly tip over, causing injury or death.

-  Do not allow others to ride on the power unit with an operator. Riders are subject to injury such as being struck by foreign objects or being thrown off. Riders obstruct the operator's view resulting in unsafe operation. **Never allow anyone to ride on the implement!**

SAFETY INSTRUCTIONS (continued)



OPERATIONAL SAFETY (continued)



Do not work under a raised loader unless it is securely blocked or held in position. Do not depend on the power unit hydraulic system to hold the implement in place.



Operate the loader controls smoothly, avoiding jerky operation. Stop loader gradually when lowering or lifting loads.



Beware of low electrical wires when loader is raised. Serious injury or death can result if contact is made.



When handling material on a slope, always approach the material with the power unit facing uphill.



When stacking material, ALWAYS MAKE SURE MATERIAL IS PLACED SO THE STACK IS STABLE.



Keep all bystanders at a safe distance. REMEMBER FALLING ITEMS CAN ROLL OR TUMBLE.



Do not handle loads that exceed the weight limitations of the loader or the attachment.



Carry the loads slowly and as low as possible to the ground. Avoid excessive speed during operation.



For operator safety, always keep load in front of power unit. NEVER position load back over operator. ALWAYS BE CAREFUL!



Beware of lift clearance when raising loader to maximum height.



Keep alert and watch the rear as well as the front when working with the loader.



When maneuvering close to buildings or passing through narrow areas, be sure to allow sufficient clearance for the power unit, loader, and load. Drive slowly.











Operate loader from operator's seat only. Remain at controls until operating cycle is complete.

SAFETY INSTRUCTIONS (continued)







OPERATIONAL SAFETY (continued)

-  Use extreme care when working on inclines and hillsides.
-  Do not operate close to ditches, creeks or holes. Slow down when operating over rough ground.
-  Keep load centered on attachment and loader. Unbalanced loads increase possibility of tipping or roll-over.
-  Never allow anyone to walk or work under a raised loader.
-  Be sure that people, livestock, or pets are not standing near the machine while operating.
-  Do not use loader for a work platform.
-  Do not lift or carry anyone on loader or in bucket or on attachment.
-  ALWAYS lower loader to the ground or block securely before performing any maintenance work.
-  Always keep power unit on solid footing when operating loader.











TRANSPORT SAFETY

-  Comply with state and local laws governing highway safety and movement of farm machinery on public roads.
-  The use of flashing amber lights is acceptable in most localities. However, some localities prohibit their use. Local laws should be checked for all highway lighting and marking requirements.
-  When driving the tractor and equipment on the road or highway under 20 mph (32 kph) at night or during the day, use flashing amber warning lights and a slow moving vehicle (SMV) identification emblem.
-  Always be sure the implement is in the proper raised position for transport.

SAFETY INSTRUCTIONS (continued)



TRANSPORT SAFETY



-  Reduce speed when transporting mounted implements to avoid bouncing and momentary loss of steering control.
-  Plan your route to avoid heavy traffic.
-  Do not drink and drive!
-  Watch for traffic when operating near or crossing roadways.
-  Turn curves or go up or down hills only at a low speed and at a gradual steering angle. Make certain that at least 20% of the tractor's weight is on the front wheels to maintain safe steering. Slow down on rough or uneven surfaces, and loose gravel.
-  Use extreme care and maintain minimum ground speed when transporting on hillside, over rough ground and when operating close to ditches or fences. Be careful when turning sharp corners.
-  Never allow riders on either power unit or implement. Falling off can kill.
-  Do not exceed 20 mph (32 kph). Reduce speed on rough roads and surfaces.



MAINTENANCE SAFETY

Good maintenance is your responsibility. Poor maintenance is an invitation to trouble. Follow good shop practices.







- Keep service area clean and dry.
- Be sure electrical outlets and tools are properly grounded.
- Use adequate light for the job at hand.

-  Make sure there is plenty of ventilation. Never operate the engine of the towing vehicle in a closed building. The exhaust fumes may cause asphyxiation.
-  Before working on this machine, drive to a level area, disengage the PTO, lower implement or loader (or if working underneath, raise and block securely), shut off the engine, relieve all hydraulic pressure, set the brakes, and remove the ignition keys.

SAFETY INSTRUCTIONS (continued)







MAINTENANCE SAFETY (continued)

-  Never work under equipment unless it is blocked securely. Never depend on hydraulic system to keep implement in raised position.
-  Keep all persons away from operator control area while performing adjustments, service, or maintenance.
-  Always use personal protection devices such as eye, hand and hearing protectors, when performing any service or maintenance.
-  Openings in the skin and minor cuts are susceptible to infection from hydraulic fluid. If injured by escaping hydraulic fluid, see a doctor at once. Gangrene and death can result. Without immediate medical treatment, serious infection and reactions can occur.
-  After servicing, be sure all tools, parts and service equipment are removed.
-  Check to ensure all safety signs are installed and in good condition. (See safety sign section for location drawing.)
-  A fire extinguisher and first aid kit should be kept readily accessible while performing maintenance on this equipment.



STORAGE SAFETY

-  Following operation or when unhooking, stop the skid steer or tractor, set the brakes, shut off the engine, relieve all hydraulic pressure and remove the ignition keys.
-  Store the unit in an area away from human activity. Do not permit children to play on or around the stored unit.
-  Do not park equipment where it will be exposed to livestock for long periods of time. Damage and livestock injury could result.
-  Make sure all parked machines are on a hard, level surface and engage all safety devices.
-  Always store pallet forks in a secure position so that they will not fall over.

SAFETY SIGNS

The types of safety signs and locations on the equipment are shown in the illustration below. Good safety requires that you familiarize yourself with various safety signs, the type of warning and the area, or particular function related to that area, that requires your **SAFETY AWARENESS**.

Refer to this section for proper label placement. To install new labels:

- Clean the area where the label is to be placed.
- Spray soapy water on the surface where the label is to be placed.
- Peel backing from label. Press firmly onto the surface.
- Squeeze out air bubbles with the edge of a credit card.

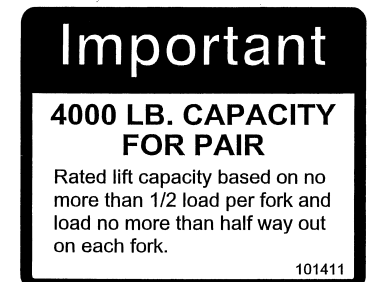
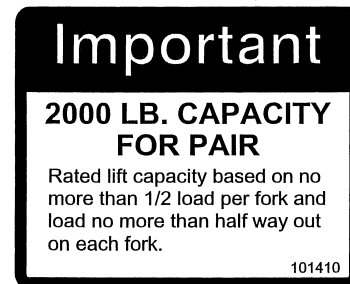
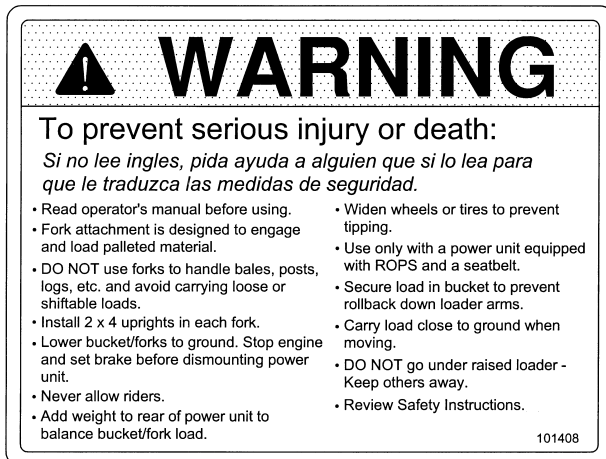
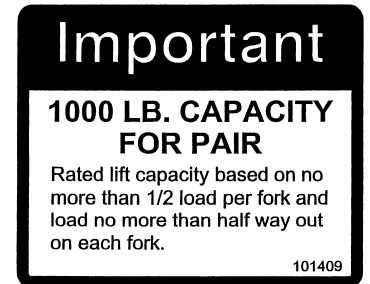
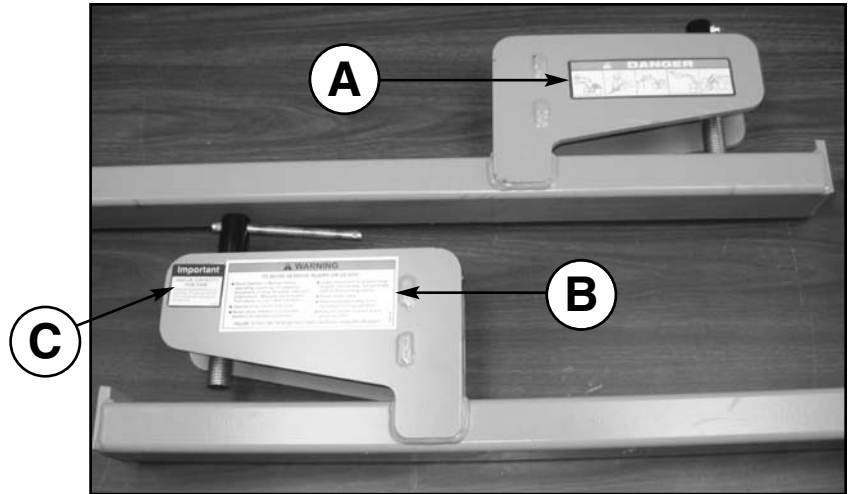

BE CAREFUL!

Use a clean, damp cloth to clean safety decals. Avoid spraying to close to decals when using a pressure washer; high-pressure water can enter through very small scratches or under edges of decals causing them to peel or come off.

REMEMBER: If Safety Signs have been damaged, removed, become illegible or parts replaced without Signs, new Safety Signs must be applied. New Safety Signs are available from your authorized distributor or factory.

INSTRUCTIONS

SPECIFICATIONS & CAPACITIES

Description	BF-1000	BF-2000	BF-4000
Lift Capacity (Per Set of 2 Pallet Forks)	1,000 lbs.	2,000 lbs.	4,000 lbs.
Tine Length	41"	41"	42"
Weight Each	39 lbs.	51 lbs.	95 lbs.
Tine Width	3"		4"
Tine Height	2"		2"
Threaded Clamp Rod	1.0 – 8NC		1.0 – 8NC
Throat Opening	5/8" – 1 3/4" Tapered		1 1/2" – 3" Tapered
Throat Depth	7"		10"
Sliding Clamp Handles	1/2" x 8"		1/2" x 8"

APPLICATION

The Bucket Mounted Pallet Forks have uses and applications in farming, ranching, construction sites, nurseries, salvage operations, warehouses, lumber yards, and large or small retail outlets. They have the capability of turning your tractor or skid steer bucket loader into a forklift for expanded material handling capability.

TRACTOR AND LOADER/SKID STEER REQUIREMENTS AND PREPARATION

The required size of the tractor and front loader or skid steer will be determined by the weight of the load to be handled.

Always use a tractor and front loader or skid steer large enough to safely handle the load.

Always know the weight of the load being lifted. Never lift a load exceeding the maximum lift capacity of the Bucket Pallet Forks and machine, whichever is less. Maximum lift capacity of the machine should be approximately 17% less than the rated lift capacity due to the increased load stresses caused by the added extension of the Bucket Pallet Forks.

Check your tractor and front loader or skid steer to make sure they are in good working condition. Check all frame mounting bolts to make sure they are tight.

Loaders that attach to the tractor frame rails should have a cross-tie installed for stability.

Check the hydraulic system. Be sure the hydraulic oil and filter have been serviced according to the manufacturer's recommendations.



Tractors and skid steers must be equipped with a roll-over protective structure (ROPS) or cab.



Be sure your tractor or skid steer is in good condition. Read all the safety precautions and make sure all operators are familiar with the safety rules of operation.

Load ratings are figured with the load about half way out on each fork and evenly distributed between the two fork tines. **NEVER** put load at the ends of the fork tines – the lift capacity at the ends of the forks is only about 1/3 of the total lift capacity. **WARRANTY DOES NOT COVER BENT FORKS.**

Be sure tires and rims are in good condition. Inflate tires to the proper recommended air pressure.

A ROPS (Roll-Over Protection Structure) and a seat belt must be installed on all tractors. Contact your local dealer for a ROPS for your tractor.

The operator is responsible for the safe operation of this equipment. The operator must be properly trained. Operators should be familiar with the tractor, loader and loader attachment, and all safety practices before starting operation. Read the safety rules and safety signs on pages 3-11.

INSTRUCTIONS (continued)

INSTALLATION

Model BF-1000, BF-2000, and BF-4000 Pallet Forks are designed for Skid Steer and Tractor buckets.



Light weight tractors and some skid steer loaders will require rear ballast for heavy loads to maintain steering control. Be sure to consult your Tractor/Skid Steer Operator's Manual to determine whether or not to add ballast.

"Right" or "Left" as used in this manual is determined by facing the direction the machine will operate while in use unless otherwise stated.

IMPORTANT: The throat opening is designed to accommodate a variety of bucket sizes and does not fit tight. Therefore, it is normal for the Pallet Forks to have some movement around the throat opening when not under load.

Two Pallet Fork Installation

Refer to Figure 1-1:

1. Open throat of Pallet Forks by unscrewing clamping screw (#2) with sliding clamp handle (#1).
2. When possible, attach the Pallet Fork to a reinforced section of the bucket 9" or more right of center of the bucket. If bucket is equipped with teeth, make sure the Pallet Fork is positioned between the teeth.
3. Slide throat of Pallet Fork onto the bucket floor until front of bucket makes contact with back of throat.
4. Position the other Pallet Fork an equal distance left of center of the front loader bucket and slide throat of Pallet Fork onto the bucket floor until the bucket front makes contact with back of throat. If bucket is equipped with teeth, make sure the unit is positioned between the teeth when sliding it on.
5. Secure Pallet Forks to the bucket by tightening handles (#1) until clamping screw (#2) is tight against the bucket floor. Do not overtighten.

IMPORTANT: Keep forklift tines adjusted to maximum width for better load stability.

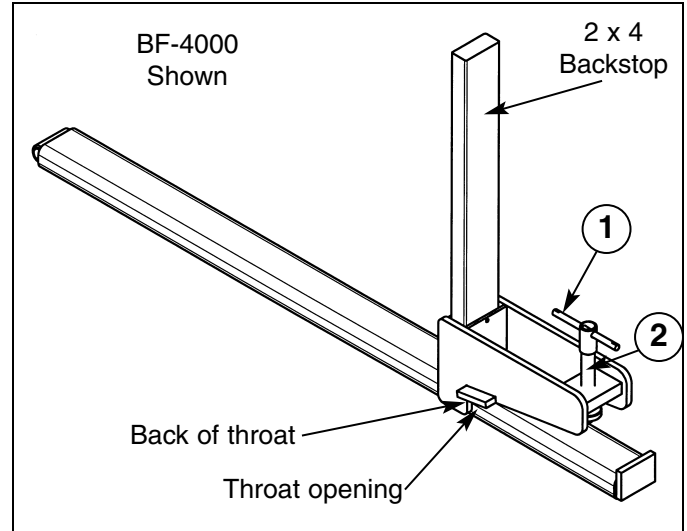

Pallet Fork Installation

Figure 1-1

NOTICE: It is NOT recommended to install the clamp-on pallet forks close to each other. This will concentrate the load in a small area of the bucket and could cause damage to the bucket. Always install the pallet forks on the bucket at least 18-20 inches apart.

NOTICE: The clamp-on pallet forks are designed for a good quality 2 x 4 piece of lumber to be inserted as an upright backstop. It is strongly recommended that the 2 x 4 backstops be installed.

The 2 x 4 backstop will help to stabilize the palletized load and provide the operator with a positive reference point as to the fork location on the bucket.

Use a 2 x 4 at least 30 inches long for an upright backstop. The 2 x 4's used on the Model BF-1000 and BF-2000 pallet forks will need to be cut to a 2 15/16" width for the lower 6" length of the 2 x 4. (See page 18.)

The 2 x 4 backstops for the Model BF-4000 pallet forks can be used without any width modifications.

**ALWAYS OBEY ALL SAFETY RULES!
ALWAYS BE CAREFUL!**

OPERATING INSTRUCTIONS

PRE-OPERATION CHECKLIST

(OWNER/OPERATOR RESPONSIBILITY)

- _____ Review and follow safety rules and safety signs on pages 3 through 11.
- _____ Check that the Clamp-on Pallet Forks are properly and securely attached to tractor loader or skid steer bucket.
- _____ Check that no one enters the area of machine operation. Always work at a safe distance from roads, built-up areas, or populated places.
- _____ Know your controls and how to stop tractor, engine and loader quickly in an emergency. READ THIS MANUAL AND THE ONE PROVIDED WITH YOUR POWER UNIT.
- _____ To avoid accident or injury, do not allow anyone to operate this equipment without proper instructions. Any person who operates this equipment must be instructed in and be capable of the safe operation of the tractor, skid steer, attachment and all controls.

SAFETY INSTRUCTIONS

Observe all instruction and safety decals on the pallet forks. These safety signs are shown for reference. Read them carefully before using the pallet forks. Replace any decals that may be faded or damaged.

Make sure all operators have read the Owner's/Operator's Manual and are familiar with the instructions and the safety rules of operation.

CAUTION!

- Do not use Pallet Forks for digging, pushing or pulling objects and do not use them for lifting objects except on pallets. Misuse of the Pallet Forks can damage the forks and bucket.
- Do not allow riders on the machine, Pallet Forks, pallets and palletized loads.
- Sound a horn before traveling in reverse. Drive at a slower speed to compensate for increased blind spots.

WARNING!

- A heavy load can cause instability in driving a tractor or skid steer. Make sure the rear of the tractor or skid steer is properly counter-balanced with weights. Always drive slowly – especially around turns. An unstable tractor or skid steer could steer badly and possibly tip over, causing injury or death.
- Using Pallet Forks will reduce stability of a machine. Always transport a load on the Pallet Forks low to the ground to help maintain stability of the load and machine. Follow recommendations provided by the manufacturer of the machine when adding counter weights and other ballast.
- Do not lift loads that exceed the back height of the bucket or if available, bucket load guard.
- Lift objects only with pallets. Make sure objects on the pallets are secure. Not using pallets can result in the load falling, damaging the machine and load, and injury to yourself and others.
- Use a "spotter" when it is hard to see in the direction you are traveling and when placing a load that obstructs your vision. A person could be standing or bent over in a blind spot.
- Transporting loads over ramps, grades, bumpy, soft and/or slippery surfaces will reduce machine stability and lift capacity. Transporting and lifting loads under these conditions is extremely dangerous.
- Keep load slightly tilted back when using Pallet Forks. Rotating the front of the Pallet Forks too high can cause the load to shift and fall on the operator and others. Rotating the front of the Pallet Forks level or lower than the back can cause the load to fall forward.
- Do not drive up to anyone standing in front of a fixed object such as a wall or bench. Never assume that the brakes will stop the machine in time.

OPERATING INSTRUCTIONS (continued)

SAFETY INSTRUCTIONS (continued)



- Beware of low electrical wires when loader is raised. Serious injury or death can result if contact is made. Place an orange warning sign under overhead electrical power lines indicating type of danger above.
- Always keep load centered on the Pallet Forks and machine at all times, even when stopped. Otherwise, the machine could tip or the load could shift and fall causing damage to the machine, load and injury to yourself and others.
- Always transport over ramps and inclines in excess of 10 percent with the load on the "uphill" side of the machine. This will require one to drive-up and back down steep inclines. Always travel straight up and down inclines and never make turns while on the incline.

Be sure power unit is properly counter-balanced with weights before attempting to lift any load with the Bucket Pallet Fork Attachment. It is recommended to attach a heavy implement or weight box on the rear of the power unit for counter weight.

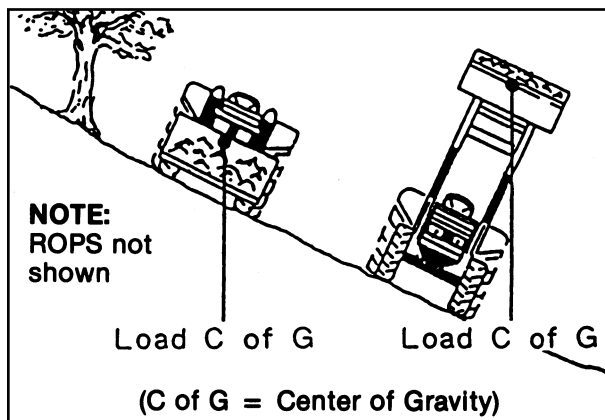

When working on side hills, **DO NOT RAISE LOADER TOO HIGH.** Keep an eye on terrain changes. Keep load low.

**OBEY ALL
SAFETY WARNINGS!**

OPERATION

1. Make sure Bucket Pallet Forks are fully on, clamping screws are in good working condition and clamped tight to the bucket.
2. Always know the weight of the load being lifted. Never lift a load exceeding the maximum lift capacity of the Pallet Forks and machine, whichever is less. Maximum lift capacity of the machine should be approximately 17% less than the rated lift capacity due to the increased load stresses caused by the added extension of the Pallet Forks.
3. Always lower Pallet Forks to ground level before dismounting from the machine. Follow manufacturer's recommendations when dismounting and parking the machine.
4. Always stack pallets in such a manner that they will not tip or fall.

Pallet Fork Operation

Picking up a load

1. Make sure the load does not exceed forklift capacity.
2. Check for overhead obstructions.
3. Stop completely before positioning the forks at the correct height.
4. Center forks under the pallet to evenly distribute the weight.
5. Make sure the load is balanced and secure.
6. Drive into the load as far as possible.
7. Lift the load slightly and tilt it back.
8. Back out slowly to clear racks or other obstacles.
9. Lower load to safe traveling height (two to five inches above the floor) before moving.

Traveling with a load

1. Keep the load tilted back slightly.
2. Keep the forks low, three to five inches above the floor, if possible.
3. Continually scan all sides for pedestrians or other traffic. Pedestrians always have the right of way.
4. If the load is large and blocks your view, travel in reverse.
5. Always drive at a safe speed and slow down when going around corners. Avoid sudden braking.
6. Leave enough clearance when turning so the Pallet Forks and load do not contact obstacles such as buildings, trees or fences.
7. When traveling over a ramp or incline, keep the load on the "uphill" side of the forklift.
8. If possible, travel straight up and down on grades, ramps, or inclines and avoid turning.
9. Lift or lower the load only when stopped, never when traveling.

OPERATING INSTRUCTIONS (continued)

OPERATION (continued)

Placing a load

1. Stop in front of desired location.
2. Slowly raise load to required height.
3. Move forward slowly with load raised.
4. Position load for placement, tilting it forward to level.
5. Place load square and straight.
6. Before backing, check all sides for pedestrians or other traffic.
7. Once the load has settled, back up slowly.
8. Make sure the forks clear the pallet before turning or changing fork height.
9. Lower forks before moving again.

CAUTION!

- Beware of lift clearance when raising loader to maximum height.
- Clamp-On Bucket Forks attachment is designed to engage and load palletized materials. Do not use forks to handle large loads such as bales, posts, etc. and avoid carrying loose or shiftable loads.
- Do not leave power unit or loader with the forks or a load raised off of the ground.

TRANSPORTING

CAUTION!

When traveling on public roads, whether at night or during the day, use accessory light and devices for adequate warnings to operators of other vehicles. Comply with all federal, state and local laws.

Carry load low.

Check visibility. If visibility is impaired, reduce speed or consider other means of transport.

Allow for additional length of loader on power unit while turning.

Select a safe ground travel speed when transporting from one area to another. When traveling on roadways, transport in such a way that faster moving vehicles may pass you safely.

When traveling over rough or hilly terrain or when making turns, slow down and use extra care.

Read all the safety warnings in the front of this manual and in the manual of tractor or skid steer unit.

MAINTENANCE

WARNING!

Always stop the tractor, set brake, shut off engine, remove key, and lower loader to ground before attempting to service. Never leave equipment unattended with engine running.

WARNING!

Do not work under a raised loader unless it is securely blocked or held in position. Do not depend on the hydraulic system to hold loader and attachment in place.

Periodically lubricate the clamping screws.

Replace any safety sign or instruction sign that is not readable or is missing. Location of such safety signs is indicated in this manual.

Replace any worn or damaged parts immediately. Do not use attachment with any damaged parts.

STORAGE

- Always store in a safe place away from children or livestock.
- Always store Pallet Forks in a secure position so that they will not fall over.

TROUBLE-SHOOTING GUIDE

PROBLEM	POSSIBLE CAUSE	POSSIBLE REMEDY
Cannot lift pallet.	1. Insufficient lift capacity.	Reduce load on pallet. Use larger capacity loader.
Tractor loader tilt cylinders won't pull back after tilting forward.	1. Loader too small for weight of material being handled. 2. Hydraulic system not operating at correct pressure.	Reduce amount of material handled. Check pressure and adjust or repair.
Excessive rear tractor tire slippage.	1. Tractor too small. 2. Insufficient traction.	Reduce amount handled. Add rear tire weights or add ballast in tire. Use tractor with FWDA. Attach heavy implement on rear of tractor for counter weight.
Bent or damaged loader bucket.	1. Pallet forks too close together. 2. Bucket was in poor condition. 3. Load handled was too heavy. 4. Load shifted and most weight went on only one fork.	Spread pallet forks apart to distribute load over larger section of bucket. Replace bucket. Check load weight and reduce amount handled. Secure load so it will not move when handled.
Bent pallet fork(s).	1. Load exceeded fork capacity. 2. Load picked up at end of fork. 3. Load shifted and most weight went on only one fork. 4. Operator picked up material that was frozen to ground.	Check load weight and reduce amount handled. Retrain operator. Secure load so it will not move when handled. In freezing conditions, check to see if pallet is froze to ground before lifting.

INSTRUCTIONS

FOR UPRIGHT BACKSTOPS

The clamp-on pallet forks are designed for a good quality 2 x 4 piece of lumber to be inserted as an upright backstop. It is strongly recommended that the 2 x 4 backstops be installed.

The 2 x 4 backstop will help to stabilize the palletized load and provide the operator with a positive reference point as to the fork location on the bucket.

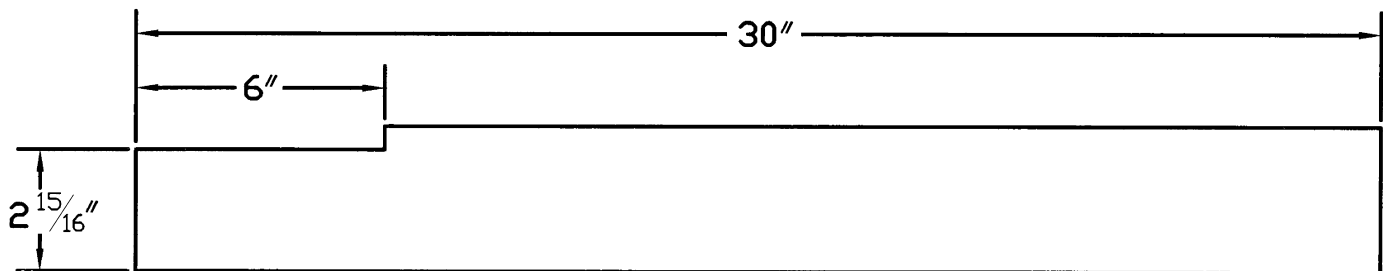

STANDARD 2x4
1.5" x 3.5"

Backstop for BF-1000 & BF-2000

Use a 2 x 4 at least 30 inches long for an upright backstop. The 2 x 4's used on the Model BF-1000 and BF-2000 pallet forks will need to be cut to a 2 15/16" width for the lower 6" length of the 2 x 4.

The 2 x 4 backstops for the Model BF-4000 pallet forks can be used without any width modifications.

BF-1000 / BF-2000 PARTS LIST

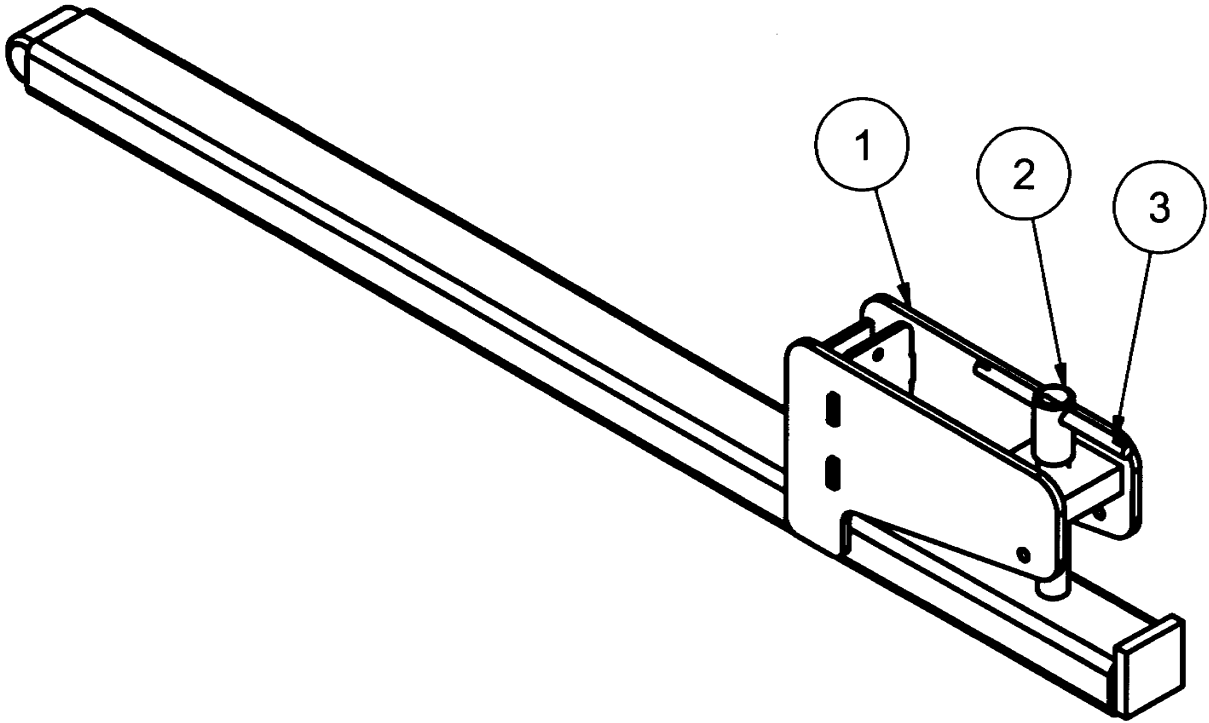

Ref. No.	Part No.	Description	No. Req'd per Fork
1	831946	Fork Weldment (BF-1000 Only)	1
1	831931	Fork Weldment (BF-2000 Only)	1
2	831940	Screw Weldment	1
3	590145	Handle, Knock-In	1
	101408	Safety Sign - Warning	1
	101412	Safety Sign - Danger	1
	101409	Safety Sign - Capacity (1000 Lbs.) (BF-1000 Only)	1
	101410	Safety Sign - Capacity (2000 Lbs.) (BF-2000 Only)	1

BF-4000 PARTS LIST

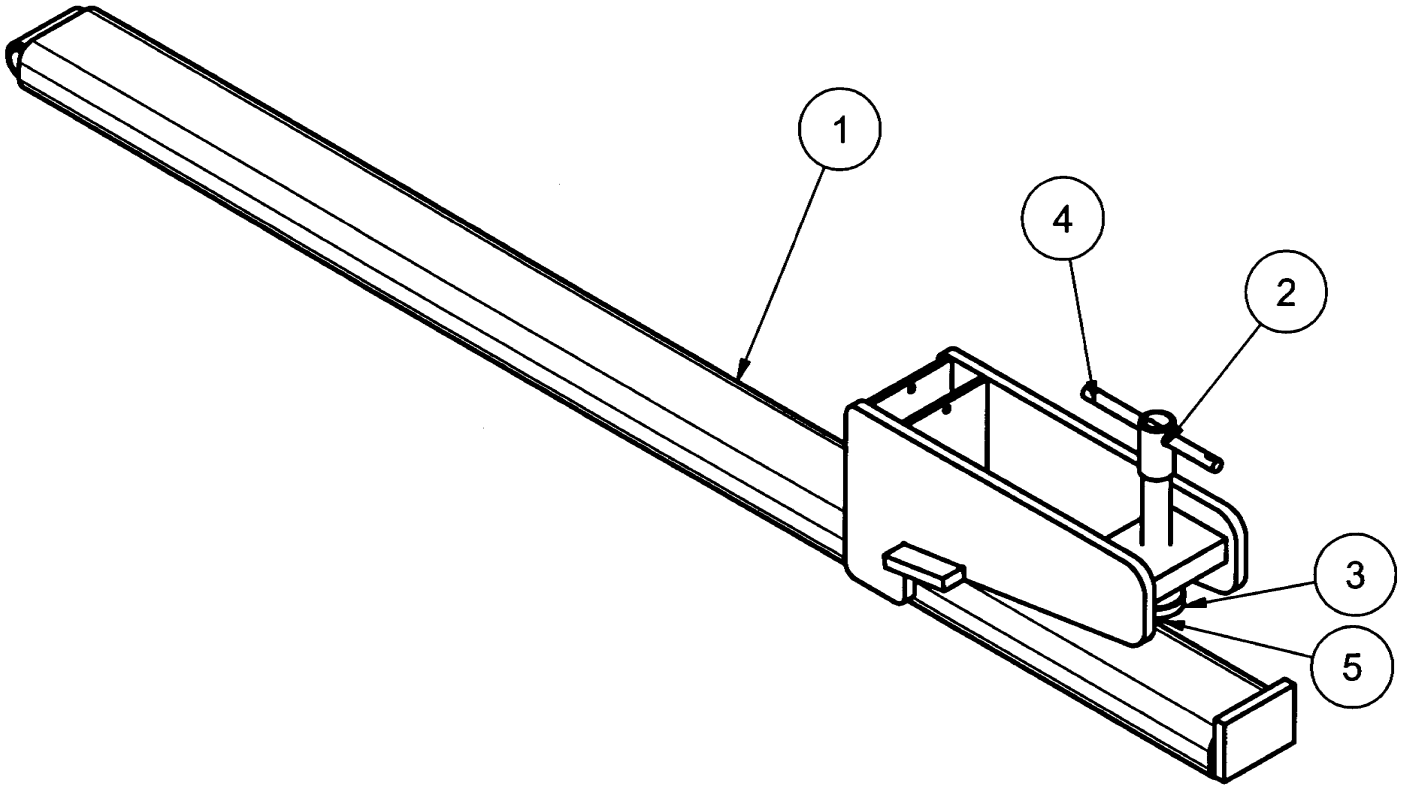

Ref. No.	Part No.	Description	No. Req'd per Fork
1	831961	Fork Weldment (BF-4000)	1
2	831970	Turn Screw	1
3	831972	Swivel Pad	1
4	590145	Handle, Knock-In	1
5	2503011	Bolt, Hex 3/8-16 x 1.0" Lg	1
	101408	Safety Sign - Warning	1
	101412	Safety Sign - Danger	1
	101152	Safety Sign - Capacity (4000 Lbs.)	1

⚠ SAFETY PRECAUTIONS ⚠

**MOST ACCIDENTS OCCUR BECAUSE OF NEGLIGENCE OR CARELESSNESS.
AVOID NEEDLESS ACCIDENTS BY FOLLOWING ALL OF THE SAFETY PRECAUTIONS LISTED BELOW.**

- Machinery should be operated only by those who are responsible and are authorized to do so.
- Stop the engine, lower all equipment, lock the brakes, and remove the ignition key before dismounting from the tractor.
- Never stand between tractor and implement while tractor is being backed to hitch.
- Loose fitting clothing should not be worn, to avoid catching on various parts.
- Detach implement in area where children normally do not play.
- When performing adjustments or maintenance on an implement, first lower it to the ground or block it securely at a workable height.
- Only a qualified operator should be permitted on tractor when in operation; no riders allowed.
- Make certain everyone is in the clear before starting tractor or raising or lowering equipment.
- Operate the tractor and implement only while seated in the driver's seat.
- Reduce speed when transporting mounted implements to avoid bouncing and momentary loss of steering control.
- A heavy load can cause instability of the tractor. Use extreme care during road travel. Slow down on turns and watch out for bumps. Tractor may need front counterweights to counter-balance the weight of the implement.
- Reduce speed on hillsides or curves so there is no danger of tipping.
- Avoid driving too close to the edge of ditches or creeks.
- Do not transport implement on public roads without reflectors and slow moving vehicle emblem in daylight and with approved warning lights at night and other periods of poor visibility.
- Due to the width of some implements, use extra caution on highways, farm roads, and when approaching gates.
- Always be sure the implement is in the proper position for transport.
- Keep alert and watch the front as well as the rear when working with the implement.

OWNER'S/ OPERATOR'S MANUAL

MODEL NO.'s

BF-1000

BF-2000

BF-4000

**WHEN ORDERING REPAIR
PARTS, ALWAYS GIVE THE
FOLLOWING INFORMATION:**

1. PART NUMBER
2. PART DESCRIPTION
3. MODEL NUMBER
4. NAME OF ITEM

MARCH 2009

CLAMP-ON BUCKET PALLET FORKS

Please work, drive, play, and live each day with care and concern for your safety and that of your family and fellow citizens.

**MAKE EVERY DAY A
HOLIDAY FROM ACCIDENTS!**

WORKSAVER, INC.

P.O. BOX 100 LITCHFIELD, IL 62056-0100 (217) 324-5973

WEB: <http://www.worksaver.com> E-MAIL: sales@worksaver.com