

OWNER'S/
OPERATOR'S
MANUAL

MODEL NO.'s

SO-905
FSO-906



Pat. No. 4,084,707

⚠ CAUTION

For Safe Operation
Read Rules And
Instructions Carefully

SINO LEEINGLES, PIDA AYUDA
A AIGUIEN QUE SI LO LEA
PARA QUE LE TRADUZCA LAS
MEDIDAS DE SEGURIDAD.

ROUND BALE FEEDER

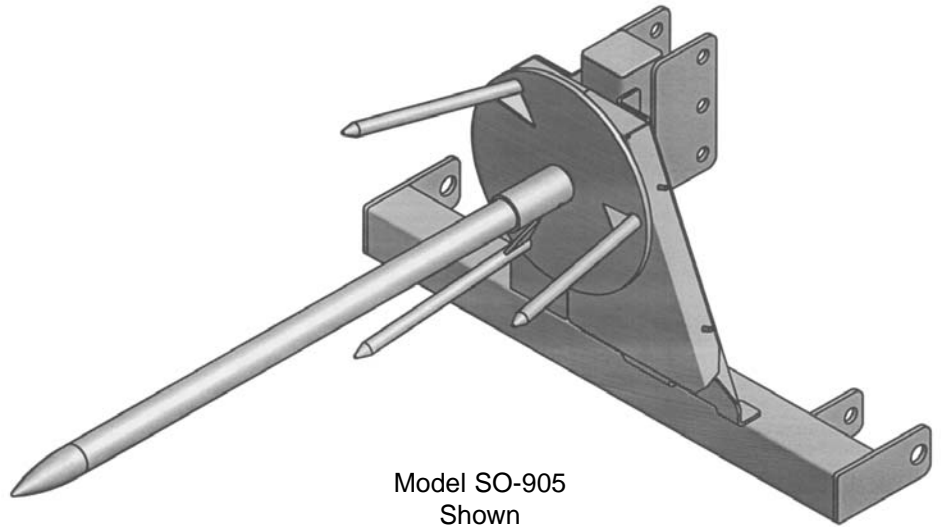

Model SO-905
Shown

RW SPINOFF 3 PT. BALE SPEAR ATTACHMENTS

Safety Instructions
Assembly & Mounting
Operating Instructions

Maintenance
Repair Parts

⚠ CAUTION ⚠

THE FOLLOWING SAFETY PRECAUTIONS SHOULD BE THOROUGHLY UNDERSTOOD
BEFORE ATTEMPTING TO BEGIN ASSEMBLING THIS MACHINE

1. Select an area for assembly that is clean and free of any debris which might cause persons working on the assembly to trip.
2. Do not lift heavy parts or assemblies. Use crane, jack, tackle, fork trucks or other mechanical devices.
3. Preview the assembly instructions in your operator's manual before proceeding further.
4. If the assembly instructions call for parts or assemblies to be blocked up, use only blocking material that is in good condition and is capable of handling the weight of the assembly to be blocked. Also insure that the blocking material is on a clean, dry surface.
5. Never put hands, or any part of body, under blocked up assemblies if at all possible.
6. After completing assembly, thoroughly inspect the machine to be sure that all nuts, bolts, hydraulic fittings or any other fastened assemblies have been thoroughly tightened.
7. Before operating the machine, thoroughly read the operation section of your operator's manual.
8. Before operating, read the maintenance section of your operator's manual to be sure that any parts requiring lubrication, such as gearboxes, are full, to avoid any possible damage.
9. **Before operating equipment – If you have any questions regarding the proper assembly or operation, contact your dealer or representative.**

TABLE OF CONTENTS

WARRANTY	2
SAFETY INFORMATION	3 - 12
SAFETY SIGNS	13
PREPARATION INSTRUCTIONS	14 - 16
OPERATING INSTRUCTIONS	17 - 18
OWNER SERVICE	19
TROUBLE-SHOOTING	20 - 22
PARTS LISTS	23 - 24

SINO LEEINGLES, PIDA AYUDA A AIGUIEN QUE SI LO LEA PARA QUE LE TRADUZCA LAS MEDIDAS DE SEGURIDAD.

STATEMENT OF POLICY

It is the policy of Worksaver, Inc. to improve its products where it is possible and practical to do so. Worksaver, Inc. reserves the right to make changes or improvements in design and construction at any time, without incurring the obligation to make these changes on previously manufactured units.

TO THE OWNER:

Read this manual before using your Bale SpinOff Attachment. This manual is provided to give you the necessary operating and maintenance instructions for keeping your Bale SpinOff Attachment in top operating condition. Please read this manual thoroughly. Understand what each control is for and how to use it. Observe all safety signs on the machine and noted throughout the manual for safe operation of implement. Keep this manual handy for ready reference.

Like all mechanical products, it will require cleaning and upkeep.

Use only genuine Worksaver, Inc. service parts. Substitute parts will void the warranty and may not meet standards required for safe and satisfactory operation. Record the model and serial number of your Attachment here:

Model: _____ Serial Number: _____

Dealer: _____ Address: _____

City, Zip: _____ Purchase Date: _____

RETAIL CUSTOMER'S RESPONSIBILITY

It is the Retail Customer and/or Operator's responsibility to read the Operator's Manual, to operate, lubricate, maintain, and store the product in accordance with all instructions and safety procedures. Failure of the operator to read the Operator's Manual is a misuse of this equipment.

It is the Retail Customer and/or Operator's responsibility to inspect the product and to have any part(s) repaired or replaced when continued operation would cause damage or excessive wear to other parts or cause a safety hazard.

It is the Retail Customer's responsibility to deliver the product to the authorized Worksaver Dealer, from whom he purchased it, for service or replacement of defective parts which are covered by warranty. Repairs to be submitted for warranty consideration must be made within forty-five (45) days of failure.

It is the Retail Customer's responsibility for any cost incurred by the Dealer for traveling to or hauling of the product for the purpose of performing a warranty obligation or inspection.

LIMITED WARRANTY



Worksaver warrants to the original purchaser of any new Bale SpinOff Attachment, that the equipment be free from defects in material and workmanship for a period of one (1) year for non-commercial, state, and municipalities. Use ninety (90) days for commercial use from date of retail sale.

Replacement or repair parts installed in the equipment covered by this warranty are warranted for ninety (90) days from the date of purchase of such part or to the expiration of the applicable new equipment warranty period, whichever occurs later.

Such parts shall be provided at no cost to the user during regular working hours. Worksaver reserves the right to inspect any equipment or parts which are claimed to have been defective in material or workmanship.

DISCLAIMER OF IMPLIED WARRANTIES & CONSEQUENTIAL DAMAGES

Worksaver's obligation under this warranty, to the extent allowed by law, is in lieu of all warranties, implied or expressed, including implied warranties of merchantability and fitness for a particular purpose and any liability for incidental and consequential damages with respect to the sale or use of the items warranted. Such incidental and consequential damages shall include but not be limited to: transportation charges other than normal freight charges; cost of installation other than cost approved by Worksaver; duty; taxes; charges for normal service or adjustments; loss of crops or any other loss of income; rental of substitute equipment, expenses due to loss, damage, detention or delay in the delivery of equipment or parts resulting from acts beyond the control of Worksaver.

THIS WARRANTY SHALL NOT APPLY:

1. To vendor items which carry their own warranties, such as hydraulic motors, tires, and tubes.
2. If the unit has been subjected to misapplication, abuse, misuse, negligence, fire or other accident.
3. If parts not made or supplied by Worksaver have been used in connection with the unit, if, in sole judgement of Worksaver such use affects its performance, stability, or reliability.
4. If the unit has been altered or repaired outside of an authorized Worksaver dealership in a manner which, in the sole judgement of Worksaver affects its performance, stability or reliability.
5. To normal maintenance service and normal replacement items such as gearbox lubricant, hydraulic fluid, drive chain, or to normal deterioration of such things as belts and exterior finish, due to use or exposure.
6. To expendable or wear items such as teeth, chains, sprockets, belts, springs and other items that in the company's sole judgement is a wear item.

NO EMPLOYEE OR REPRESENTATIVE OF WORKSAVER IS AUTHORIZED TO CHANGE THIS WARRANTY IN ANY WAY OR GRANT ANY OTHER WARRANTY UNLESS SUCH CHANGE IS MADE IN WRITING AND SIGNED BY WORKSAVER'S SERVICE MANAGER, POST OFFICE BOX 100, LITCHFIELD, ILLINOIS 62056-0100.



To the Owner/Operator/Dealer

All implements with moving parts are potentially hazardous. There is no substitute for a cautious, safe-minded operator who recognizes the potential hazards and follows reasonable safety practices. The manufacturer has designed this implement to be used with all its safety equipment properly attached to minimize the chance of accidents.

BEFORE YOU START!!

**Read the safety messages on the implement and shown in your manual.
Observe the rules of safety and common sense!**



THIS SYMBOL MEANS

- ATTENTION!
- BECOME ALERT!
- YOUR SAFETY IS INVOLVED!

THIS SAFETY ALERT SYMBOL IDENTIFIES IMPORTANT SAFETY WARNING MESSAGES. CAREFULLY READ EACH WARNING MESSAGE THAT FOLLOWS. FAILURE TO UNDERSTAND AND OBEY A SAFETY WARNING, OR RECOGNIZE A SAFETY HAZARD, COULD RESULT IN AN INJURY OR DEATH TO YOU OR OTHERS AROUND YOU. THE OPERATOR IS ULTIMATELY RESPONSIBLE FOR THE SAFETY OF HIMSELF, AS WELL AS OTHERS, IN THE OPERATING AREA OF THE TRACTOR AND ATTACHED EQUIPMENT.

UNDERSTAND SIGNAL WORDS

Note the use of the signal words **DANGER**, **WARNING** and **CAUTION** with the safety messages. The appropriate signal word for each has been selected using the following guidelines:

DANGER: Indicates an imminently hazardous situation that, if not avoided, will result in death or serious injury. This signal word is to be limited to the most extreme situations typically for machine components which, for functional purposes, cannot be guarded.

WARNING: Indicates a potentially hazardous situation that, if not avoided, could result in death or serious injury, and includes hazards that are exposed when guards are removed. It may also be used to alert against unsafe practices.

CAUTION: Indicates a potentially hazardous situation that, if not avoided, may result in minor or moderate injury. It may also be used to alert against unsafe practices.

If you have questions not answered in this manual or require additional copies or the manual is damaged, please contact your dealer or the manufacturer directly.

IMPORTANT SAFETY INFORMATION!

Working with unfamiliar equipment can lead to careless injuries. Read this manual, and the manual for your tractor, before assembly or operating, to acquaint yourself with the machines. It is the implement owner's responsibility, if this machine is used by any person other than yourself, is loaned or rented, to make certain that the operator, prior to operating:

1. Reads and understands the operator's manuals.
2. Is instructed in safe and proper use.





The use of this equipment is subject to certain hazards which cannot be protected against by mechanical means or product design. All operators of this equipment must read and understand this entire manual, paying particular attention to safety and operating instructions, prior to using. If there is something in this manual you do not understand, ask your supervisor, or your dealer, to explain it to you.

SAFETY INSTRUCTIONS (continued)





EQUIPMENT SAFETY GUIDELINES

-  Safety of the operator is one of the main concerns in designing and developing a new piece of equipment. Designers and manufacturers build in as many safety features as possible. However, every year many accidents occur which could have been avoided by a few seconds of thought and a more careful approach to handling equipment. You, the operator, can avoid many accidents by observing the following precautions in this section. To avoid personal injury, study the following precautions and insist those working with you, or for you, follow them.

-  In order to provide a better view, certain photographs or illustrations in this manual may show an assembly with a safety shield removed. However, equipment should never be operated in this condition. Keep all shields in place. If shield removal becomes necessary for repairs, replace the shield prior to use.

-  Replace any CAUTION, WARNING, DANGER or instruction safety sign that is not readable or is missing. Location of such safety signs is indicated in this booklet.

-  Never use alcoholic beverages or drugs which can hinder alertness or coordination while operating this equipment. Consult your doctor about operating this machine while taking prescription medications.

-  Review the safety instructions with all users annually.

-  This equipment is dangerous to children and persons unfamiliar with its operation. The operator should be a responsible adult familiar with farm machinery and trained in this equipment's operations. **Do not allow persons to operate or assemble this unit until they have read this manual and have developed a thorough understanding of the safety precautions and of how it works.**

-  To prevent injury or death, use a tractor equipped with a Roll-Over Protective System (ROPS). Do not paint over, remove or deface any safety signs or warning signs on your equipment. Observe all safety signs and practice the instruction on them.

-  Never exceed the limits of a piece of machinery. If its ability to do a job, or to do so safely, is in question – **DON'T TRY IT.**





-  Do not modify the equipment in any way. Unauthorized modification may impair the function and/or safety and could affect the life of the equipment.

-  In addition to the design and configuration of this implement, including Safety Signs and Safety Equipment, hazard control and accident prevention are dependent upon the awareness, concern, prudence, and proper training of personnel involved in the operation, transport, maintenance, and storage of the machine. Refer also to Safety Messages and Operation Instructions in each of the appropriate sections of the Tractor and Loader Manuals. Pay close attention to the Safety Signs affixed to the Tractor and the Loader.







SAFETY INSTRUCTIONS (continued)



SAFETY SIGNS





-  Keep safety signs clean and legible at all times.
-  Replace safety signs that are missing or have become illegible.
-  Replaced parts that displayed a safety sign should also display the current sign.
-  Safety signs are available from your Distributor or Dealer Parts Department or the factory.

How to Install Safety Signs:

-  Be sure that the installation area is clean and dry.
-  Be sure temperature is above 50°F (10°C).
-  Decide on the exact position before you remove the backing paper.
-  Remove the smallest portion of the split backing paper.
-  Align the sign over the specified area and carefully press the small portion with the exposed sticky backing in place.
-  Slowly peel back the remaining paper and carefully smooth the remaining portion of the sign in place.
-  Small air pockets can be pierced with a pin and smoothed out using the piece of sign backing paper.



TIRE SAFETY

-  Failure to follow proper procedures when mounting a tire on a wheel or rim can produce an explosion which may result in serious injury or death.
-  Do not attempt to mount a tire unless you have the proper equipment and experience to do the job.
-  Inflating or servicing tires can be dangerous. Whenever possible, trained personnel should be called to service and/or mount tires.
-  Always order and install tires and wheels with appropriate capacity to meet or exceed the anticipated weight to be placed on the equipment.

SAFETY INSTRUCTIONS (continued)



SAFETY TRAINING

 Safety is a primary concern in the design and manufacture of our products. Unfortunately, our efforts to provide safe equipment can be wiped out by a single careless act of an operator.

 In addition to the design and configuration of equipment, hazard control and accident prevention are dependent upon the awareness, concern, prudence and proper training of personnel involved in the operation, transport, maintenance and storage of equipment.

 It has been said, "The best safety device is an informed, careful operator." We ask you to be that kind of an operator. It is the operator's responsibility to read and understand ALL Safety and Operating instructions in the manual and to follow these. Accidents can be avoided.

 Working with unfamiliar equipment can lead to careless injuries. Read this manual, and the manual for your tractor, before assembly or operating, to acquaint yourself with the machines. It is the equipment owner's responsibility, if this machine is used by any person other than yourself, is loaned or rented, to make certain that the operator, prior to operating:

1. Reads and understands the operator's manuals.
2. Is instructed in safe and proper use.

 Know your controls and how to stop tractor, engine, and implement quickly in an emergency. Read this manual and the one provided with your tractor.

 Train all new personnel and review instructions frequently with existing workers. A person who has not read and understood all operating and safety instructions is not qualified to operate the machine. An untrained operator exposes himself and bystanders to possible serious injury or death.

 Do not allow children to operate this machine.



PREPARATION

 Never operate the tractor, loader, and attachment until you have read and completely understand this manual, the Tractor Operator's Manual, and each of the Safety Messages found on the safety signs on the tractor, loader, and attachment.

SAFETY INSTRUCTIONS (continued)



PREPARATION (continued)



Personal protection equipment including hard hat, safety glasses, safety shoes, and gloves are recommended during assembly, installation, operation, adjustment, maintaining, repairing, removal, or moving the implement. Do not allow long hair, loose fitting clothing or jewelry to be around moving parts.



PROLONGED EXPOSURE TO LOUD NOISE MAY CAUSE PERMANENT HEARING LOSS!

Tractors with or without equipment attached can often be noisy enough to cause permanent, partial hearing loss. We recommend that you wear hearing protection on a full-time basis if the noise in the Operator's position exceeds 80db. Noise over 85db on a long-term basis can cause severe hearing loss. Noise over 90db adjacent to the Operator over a long-term basis may cause permanent, total hearing loss. **NOTE:** Hearing loss from loud noise (from tractors, chain saws, radios, and other such sources close to the ear) is cumulative over a lifetime without hope of natural recovery.



Operate the loader attachment only with a tractor equipped with an approved Roll-Over Protective System (ROPS). Always wear your seat belt on tractors equipped with a ROPS. Serious injury or even death could result from falling off the tractor – particularly during a turnover when the operator could be pinned under the ROPS or the tractor. Keep foldable ROPS systems in “locked up” position at all times.



Operate only in daylight or good artificial light.



Ensure attachment is properly mounted, adjusted and in good operating condition.



Ensure that all safety shielding and safety signs are properly installed and in good condition. Keep all guards in place when in operation or tractor is running.



Never permit any person other than the operator to ride or board the tractor or implement at any time. **ALLOW NO RIDERS!**



The use of any loader attachment is NOT recommended on tractor with a tricycle wheel arrangement. Tricycle type tractors are unstable for front loader use.



A heavy load can cause instability in driving a tractor. Make sure the front or rear of the tractor is properly counter-balanced with weights. Always drive slowly – especially around turns. An unstable tractor could steer badly and possibly tip over, causing injury or death.



OPERATIONAL SAFETY



















The use of this equipment is subject to certain hazards which cannot be protected against by mechanical means or product design. All operators of this equipment must read and understand this entire manual, paying particular attention to safety and operating instructions, prior to using. If there is something in this manual you do not understand, ask your supervisor, or your dealer, to explain it to you.

SAFETY INSTRUCTIONS (continued)















OPERATIONAL SAFETY (continued)

-  Most accidents occur because of neglect or carelessness. Keep all helpers and bystanders at a safe distance. **REMEMBER FALLING BALES CAN ROLL OR TUMBLE.**
-  Beware of low electrical wires when loader is raised. Serious injury or death can result if contact is made.
-  Do not handle bales that exceed the bale weight limitations of the attachment. Watch for bales that are frozen to the ground.
-  Carry the bale slowly and as low as possible to the ground.
-  Operate the hydraulic controls smoothly, avoiding jerky operation.
-  When handling round bales on a slope, always approach the bale with the tractor facing uphill.
-  Never use the tractor/loader to stop a rolling bale.
-  Only use a tractor equipped with a ROPS cab or rollover protective structure. Keep foldable ROPS systems in "locked up" position at all times. Keep seat belt fastened.
-  When stacking bales, **ALWAYS MAKE SURE BALES ARE PLACED SO THE STACK IS STABLE.**
-  For operator safety when using a front loader, always keep bale in front of tractor hood. **NEVER** position bale back over operator. **ALWAYS BE CAREFUL!**
-  Always load rear of tractor first and unload last when using a front loader.
-  Beware of lift clearance when raising loader to maximum height.
-  Keep alert and watch the rear as well as the front when working with the loader.
-  When maneuvering close to buildings or passing through narrow areas, be sure to allow sufficient clearance for the tractor, loader, and rear 3 pt. attachment. Drive slowly.
-  Operate loader and attachment from operator's seat only. Remain at controls until operating cycle is complete.
-  Stop loader gradually when lowering or lifting loads.

SAFETY INSTRUCTIONS (continued)



















OPERATIONAL SAFETY (continued)

-  Allow for additional length of loader, bale and rear 3 pt. attachment on tractor while turning.
-  Never allow anyone to walk or work under a raised loader. Do not use loader for a work platform. Do not lift or carry anyone on loader or in bucket or on attachment.
-  Set both front and rear tractor wheels wide for increased stability.
-  Be sure that people, livestock, or pets are not standing near the machine while operating. Be careful when backing up to a bale. Make sure that people and animals are not between the spike and the bale.
-  ALWAYS lower loader and/or 3 pt. attachment to the ground or block securely before performing any maintenance work.
-  Stay alert for holes, rocks and roots in the terrain and other hidden hazards. Keep away from drop-offs.
-  Use extreme care and maintain minimum ground speed when transporting on hillside, over rough ground and when operating close to ditches or fences. Be careful when turning sharp corners.
-  Reduce speed on slopes and sharp turns to minimize tipping or loss of control. Be careful when changing directions on slopes. Do not start or stop suddenly on slopes. Avoid operation on steep slopes.
-  When using a unit, a minimum 20% of tractor and equipment weight must be on tractor front wheels. Without this weight, tractor could tip over, causing personal injury or death. The weight may be attained with a front end loader, front wheel weights, ballast in tires or front tractor weights. When attaining a minimum 20% of tractor and equipment weight on the front wheels, you must not exceed the ROPS weight certification. Weigh the tractor and equipment. Do not guess or estimate!
-  Avoid excessive speed during operation.
-  ALWAYS lower spear points to the ground when parking tractor. Raised spear points could cause injury to people or livestock.
-  Always shut off tractor and shift to "Park" or set brakes when leaving tractor. Always lower bucket or attachment to ground. Remove key when leaving tractor unattended.
-  Before operating equipment: if you have any questions regarding the proper assembly or operation, contact your dealer or representative.

SAFETY INSTRUCTIONS (continued)



TRANSPORT SAFETY

-  Comply with state and local laws governing highway safety and movement of farm machinery on public roads.
-  The use of flashing amber lights is acceptable in most localities. However, some localities prohibit their use. Local laws should be checked for all highway lighting and marking requirements.
-  When driving the tractor and equipment on the road or highway under 20 mph (32 kph) at night or during the day, use flashing amber warning lights and a slow moving vehicle (SMV) identification emblem.
-  Always be sure the implement is in the proper raised position for transport.
-  Reduce speed when transporting mounted implements to avoid bouncing and momentary loss of steering control.
-  Plan your route to avoid heavy traffic.
-  Make sure large round bales transported on tractor rear 3 pt. hitch do not obstruct visibility of tractor's flashing lights or SMV sign.
-  When transporting large round bales, keep load as low as practical to maximize tractor stability.
-  Transporting large round bales on front loaders can limit visibility. Keep load low and go slow if visibility is obstructed. Always use extra care.
-  Do not exceed 20 mph (32 kph). Reduce speed on rough roads and surfaces.
-  Do not drink and drive!
-  Watch for traffic when operating near or crossing roadways.
-  Turn curves or go up or down hills only at a low speed and at a gradual steering angle. Make certain that at least 20% of the tractor's weight is on the front wheels to maintain safe steerage. Slow down on rough or uneven surfaces, and loose gravel.
-  Use extreme care and maintain minimum ground speed when transporting on hillside, over rough ground and when operating close to ditches or fences. Be careful when turning sharp corners.
-  Never allow riders on either tractor or implement. Falling off can kill.
-  Be a safe and courteous driver. Always yield to oncoming traffic in all situations, including narrow bridges, intersections, etc.

SAFETY INSTRUCTIONS (continued)



MAINTENANCE SAFETY



Good maintenance is your responsibility. Poor maintenance is an invitation to trouble.



Follow good shop practices.

- Keep service area clean and dry.
- Be sure electrical outlets and tools are properly grounded.
- Use adequate light for the job at hand.



Make sure there is plenty of ventilation. Never operate the engine of the towing vehicle in a closed building. The exhaust fumes may cause asphyxiation.



Before working on this machine, drive to a level area, disengage the PTO, lower implement (or if working underneath, raise and block securely), shut off the engine, relieve hydraulic pressure, set the brakes, and remove the ignition keys.



Be certain all moving parts on attachments have come to a complete stop before attempting to perform maintenance.



Never work under equipment unless it is blocked securely. Never depend on hydraulic system to keep implement in raised position.



Keep all persons away from operator control area while performing adjustments, service, or maintenance.



Always use personal protection devices such as eye, hand and hearing protectors, when performing any service or maintenance.



Periodically tighten all bolts, nuts and screws and check that all cotter pins are properly installed to ensure unit is in a safe condition.



When completing a maintenance or service function, make sure all safety shields and devices are installed before placing unit in service.



Never use your hands to locate a hydraulic leak on attachments. Use a small piece of cardboard or wood. Hydraulic fluid escaping under pressure can penetrate the skin.



Openings in the skin and minor cuts are susceptible to infection from hydraulic fluid. If injured by escaping hydraulic fluid, see a doctor at once. Gangrene and death can result. Without immediate medical treatment, serious infection and reactions can occur.

SAFETY INSTRUCTIONS (continued)









MAINTENANCE SAFETY (continued)

-  After servicing, be sure all tools, parts and service equipment are removed.
-  Check to ensure all safety signs are installed and in good condition.
-  It is important to shut off tractor and disconnect hydraulic hoses when servicing the chain or performing any other maintenance.
-  Where replacement parts are necessary for periodic maintenance and servicing, genuine factory replacement parts must be used to restore your equipment to original specifications. The manufacturer will not claim responsibility for use of unapproved parts and/or accessories and other damages as a result of their use.
-  If equipment has been altered in any way from original design, the manufacturer does not accept any liability for injury or warranty.
-  A fire extinguisher and first aid kit should be kept readily accessible while performing maintenance on this equipment.



STORAGE SAFETY

-  Following operation or when unhooking, stop the tractor, set the brakes, disengage the PTO, shut off the engine and remove the ignition keys.
-  Store the unit in an area away from human activity.
-  Do not park equipment where it will be exposed to livestock for long periods of time. Damage and livestock injury could result.
-  Do not permit children to play on or around the stored unit.
-  Make sure all parked machines are on a hard, level surface and engage all safety devices.
-  If blocking is used, make sure it is solid and secure before leaving area.

SAFETY SIGNS

NOTE:

If Safety Sign is missing or damaged, replace immediately.

 WARNING	
	
<p>HIGH-PRESSURE FLUID HAZARD</p> <p>To prevent serious injury or death:</p> <ul style="list-style-type: none"> • Relieve pressure on system before repairing or adjusting or disconnecting. • Wear proper hand and eye protection when searching for leaks. Use wood or cardboard instead of hands. • Keep all components in good repair. 	
<small>SW700</small>	

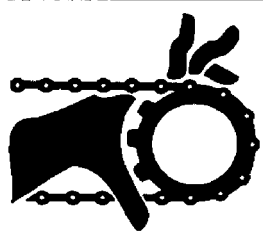

- Read and follow owner's manual before installing, operating, or performing maintenance on this loader. Observe safety recommendations in manual.
- Do not exceed weight limit of loader or tractor.
- Do not lift or carry anyone on loader or in bucket or attachment.
- For operator safety, always keep load in front of tractor hood. NEVER position load back over operator.
- Add recommended wheel ballast or rear weight for stability. When handling loads on both ends of tractor, load rear first and unload last.
- Set wheels wide for increased stability.
- Never raise loader to extreme heights on steep inclines.
- Do not stand or work under raised loader.
- Stop engine, lower arms, relieve all hydraulic pressure, and lock brakes before leaving operator's seat.
- When handling round bales with fork type equipment, be sure bolt-in stabilizer spike is installed. Without spike, uncontrolled bale movement could occur.
- Failure to observe the above precautions can result in serious injury or death.

 WARNING

<p>Moving chains and sprocket</p> <p>Can cause loss of fingers</p> <p>Keep guards in place</p> <p>Shut off tractor when servicing chain</p>
<small>LB 303</small>

 DANGER

<ul style="list-style-type: none"> • Rotating hay spikes • Contact can cause bodily injuries • Keep away
<small>LB300</small>

INSTRUCTIONS

INTRODUCTION

The Bale SpinOff Models SO-905 and FSO-906 are designed for use on Category II and Category III tractors equipped with a 3 pt. hitch and/or a Category II or III quick hitch. It can be used on larger Category I tractors if the tractor is properly equipped with front end weights.

NOTE: For use on Category I tractors, you must order a special pin and bushing kit. Order #830295.

The Model SO-905 Bale SpinOff will transport and unroll round bales up to 2,000 lbs. The Model FSO-906 will handle round bales up to 2,200 lbs.

NOTE: The Bale SpinOff is designed for transporting and unrolling large round hay bales only. **NEVER** attempt to use it for any other purpose.

TRACTOR REQUIREMENTS AND PREPARATION

The required size of the tractor and front loader will be determined by the size and weight of the bales to be handled.

Remember, high moisture hay (silage) bales are very heavy in relation to similar size dry hay bales.

Always use a tractor large enough to safely handle your bales.

Check the tractor's 3 pt. hydraulic lift system. It should operate up and down smoothly and hold its position when set. Refer to your tractor owner's manual or dealer for any adjustments necessary to put the 3 pt. hydraulic lift system in good working order. (I&T shop manuals will list most specifications and adjustment instructions – available from most farm equipment dealers.)

The tractor must be equipped with one pair hydraulic remote couplers and a hydraulic system with a minimum of 1,500 psi and 8-10 gpm.

Check the hydraulic system. Be sure the tractor hydraulic oil and filter have been serviced according to the tractor manufacturer's recommendations.

Tractor should be equipped with stabilizer bars, adjustable sway chains, or sway blocks to keep the implement from swinging side to side.

Smaller size tractors may need front counter weights to counter-balance the weight of the implement.

It is recommended that the tractor be equipped with a Rollover Protection System (ROPS) and a seat belt that is used.

! CAUTION! !

Be sure your tractor and loader is in good condition. Read all the safety precautions and make sure all equipment operators are familiar with the safety rules of operation.

! WARNING! !

When using the unit, a minimum 20% of tractor and equipment weight must be on tractor front wheels. Without this weight, tractor could tip up, causing possible loss of control and possible personal injury or death. The weight may be attained with a front end loader, front wheel weights, ballast in tires or front tractor weights. When attaining a minimum 20% of tractor and equipment weight on the front wheels, you must not exceed the ROPS weight certification. Weigh the tractor and equipment. **DO NOT GUESS OR ESTIMATE!**

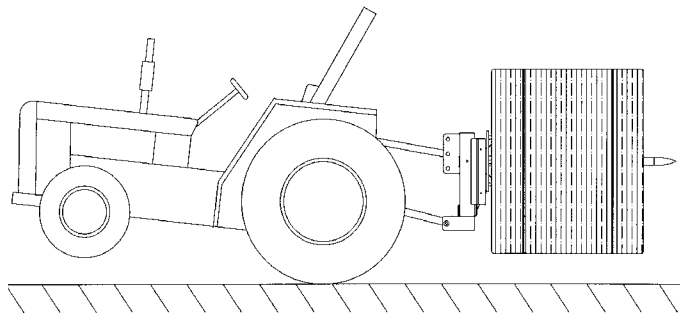

Figure 1. Tractor Stability

! WARNING! !

A heavy load can cause instability in driving a tractor. Make sure the front of the tractor is properly counter-balanced with weights. Always drive slowly – especially around turns. An unstable tractor could steer badly and possibly tip over, causing injury or death.

INSTRUCTIONS (continued)



Power unit must be equipped with ROPS or ROPS cab and seat belt. Keep seat belt securely fastened. Falling off power unit can result in death from being run over or crushed. Keep foldable ROPS systems in “locked up” position at all times.

ASSEMBLY & MOUNTING

Refer to the “exploded views” on pages 23-24 of this manual.

Carefully follow instructions for final assembly.

Before attempting assembly check the following items. Having all the needed parts and equipment readily at hand will speed up your assembly task and will make the job as safe as possible.

- Check for fasteners and pins that were shipped with the attachment.
- Have a minimum of 2 people at hand during assembly.

Step 1. Remove both the left hand (Ref. #4) and right hand (Ref. #3) chain shield(s) from the main frame weldment.

Step 2. Attach the hydraulic motor mount (Ref. #7) to the hydraulic motor (Ref. #11) with the two 1/2” X 1.25” carriage bolts, 1/2” lock-washers, and nuts. Tighten these bolts to 35 Ft. Lbs.

Step 3. Remove the 1/2” nuts, lockwashers, and flat washers from the four (4) welded carriage bolts on the right side of the frame.

Position the hydraulic motor mount on the four (4) welded carriage bolts and plate a flatwasher, lockwasher, and nut on each of these bolts.

Leave these nuts loose, as you will need to slide the motor and motor mount up or down to adjust the chain tension.

Step 4. Place the collar assembly (Ref. #6) about 13.25” from the blunt end of the main spear (Ref. #8). Just lightly tighten the set screw in the collar to hold it in place.

Step 5. Tip the main frame to a horizontal position (laying on the 3 pt. hitch lugs and the toplink brackets).

Step 6. Place the spinner assembly (Ref. #2) in a position over the large hole in the main frame. (The large sprocket will be close to the frame with the three (3) spikes pointing up.

Step 7. Insert the blunt end of the main spike (Ref. #8) through the spinner assembly and then into the hole in the main frame. Align the hole in the main spike with the holes in the main frame and bolt using the 1/2” X 4 1/2” hex head bolt (Ref #16). Install the 1/2” lockwasher and nut on this bolt.

Step 8. Securely block the main spear in a level horizontal position.

Step 9. Loosen the set screw in the collar (Ref. #6) and slide it toward the main frame. The spinner assembly should not slide on the main spike more than 1/16” horizontally. Tighten the set screw in the collar.

Step 10. Use a grease gun to grease the spinner assembly via the grease zerk. Rotate the spinner assembly by hand to make sure the grease is uniformly distributed between the main spike and the spinner assembly.

Step 11. Install the small sprocket onto the hydraulic motor shaft with the set screw toward the motor. Make sure the key is in the motor shaft. Align the small sprocket with the large sprocket on the spinner assembly using a straight edge. Tighten the set screws on the small sprocket.

Step 12. Lift the hydraulic motor and mounting plate up as far as the slots will allow and snug one of the nuts to hold in place.

Install the roller chain (Ref. #10) using the master chain link (Ref. #20).

Loosen the one nut and move the motor mount downward. Tighten the four nuts to lock the hydraulic motor in position. The chain should have 1/8” to 3/16” deflection.

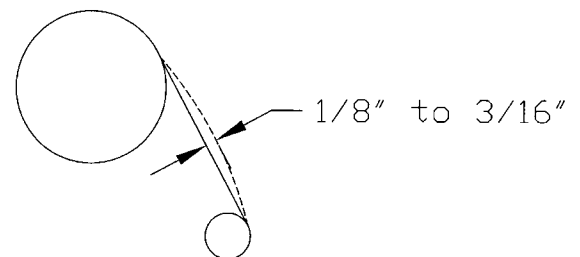

NOTE: The chain will have to be re-adjusted after the first 4-5 bales, as it will stretch slightly with use.

Step 13. Install the Left Hand and Right Hand chain shields on the main frame. Tighten the four plastic knobs firmly.

INSTRUCTIONS (continued)

ASSEMBLY & MOUNTING (continued)



Do not operate this equipment without shields properly installed. This is for your protection, and the manufacturer recommends the use of these shields at all times while operating this implement.

Step 14. The hoses and fittings are included on the Model SO-905 and FSO-906 (3 pt. models). Quick couplers are not included.

The ports in the hydraulic motor accept $\frac{7}{8}$ - 14 straight thread o-ring male fittings. Use a good grade liquid thread sealant. **Do not use TEFLON thread tape, as this can contaminate the hydraulic system.**

Route the hose to avoid pinching or chafing the hose. Use nylon ties or tape to fasten hose to keep it in place.



Escaping hydraulic fluid under pressure can penetrate the skin, causing serious injury.

DO NOT use your hand to check for leaks. Use a piece of cardboard or paper to search for leaks.

Stop engine and relieve pressure before connecting or disconnecting lines.

Tighten all connections before starting engine or pressurizing lines.

If any fluid is injected into the skin, obtain medical attention immediately, or gangrene may result.

Step 15. Attach the Bale SpinOff to the tractor. The lower stepped hitch pins allow connecting to both Category II and Category III hitches or Quick hitches.

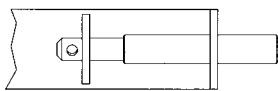

Cat II Hitch

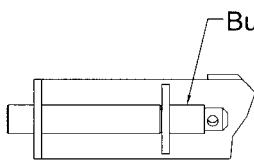

Bushing

Cat II Q. Hitch

Cat III Hitch

Cat III Q. Hitch

Connect the topline with a Category II topline pin. If your topline is a Category III, use a Category II to III topline bushing (available at your dealer). For Category I hitches, order optional pin kit #830295.

SAFETY INSTRUCTIONS

Observe all instruction and safety decals on the Hydraulic Bale SpinOff. These safety signs are shown for reference. Read them carefully before using the Hydraulic Bale SpinOff. Replace any decals that may be faded or damaged.

Make sure all operators have read the Owner's Manual and are familiar with the instructions and the safety rules of operation.

PRE-OPERATION CHECKLIST

(OWNER/OPERATOR RESPONSIBILITY)

- Review and follow safety rules and safety signs on pages 3 through 13.
- Check that Hydraulic Bale SpinOff is properly and securely attached to tractor.
- Lubricate all grease fitting locations.
- Check that all hardware is properly installed.
- Check that no one enters the area of machine operation. Always work at a safe distance from people.
- Know your controls and how to stop tractor, engine, hydraulic system and PTO quickly in an emergency. **READ THIS MANUAL AND THE ONE PROVIDED WITH YOUR POWER UNIT.**
- To avoid accident or injury, do not allow anyone to operate this equipment without proper instructions. Any person who operates this equipment must be instructed in and be capable of the safe operation of the tractor, attachment and all controls.



NEVER LET ANYONE CLIMB ON STACKED ROUND HAY BALES!



**ALWAYS OBEY ALL SAFETY RULES!
ALWAYS BE CAREFUL!**

OPERATING INSTRUCTIONS

OPERATION

The operator is responsible for the safe operation of this equipment. The operator must be properly trained. Operators should be familiar with the attachment, tractor, and loader and all safety practices before starting operation.

Make sure all operators have read the Owner's/Operator's Manual and are familiar with the instructions and the safety rules of operation.

USING THE SPINOFF AS A BALE FEEDER

1. Install the SpinOff on the tractor in accordance with mounting instructions and common three point mounting practices.
2. Connect the hydraulic hoses. Make sure the quick coupler ends are clean before insertion.
3. Back the tractor toward either end of the bale while keeping the center shaft horizontal and near the center of the bale.
4. Continue backing until the center shaft and spinner are fully inserted into the bale.
5. Raise the three point hitch.
6. Drive to the desired range feeding location.
7. Remove the bale twine and dispose of it properly.
8. Do not lower the bale to the ground. The rear end of the bale should be higher than the forward end to keep the bale from sliding off the center shaft.
9. Select tractor gear.
10. Set the throttle a little above idle.
11. When the tractor is in a forward motion, slowly engage the hydraulic lever to rotate the bale. This will unroll the hay into a windrow.
12. Adjust the forward speed of the tractor to adjust the windrow size. A faster speed for a smaller windrow, a slower speed for a larger windrow.
13. Experiment with different forward speeds and rotation of the bale to unroll the desired windrow.

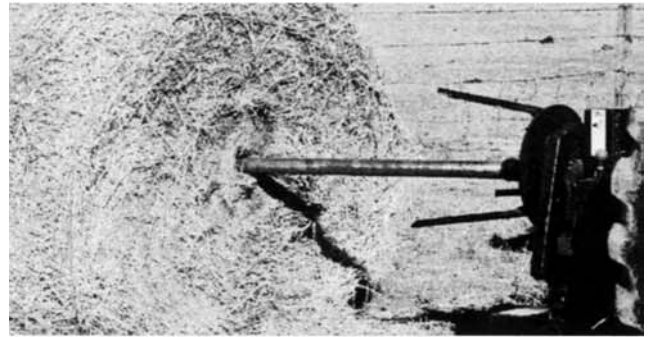

OPERATING INSTRUCTIONS (continued)

OPERATION (continued)



A heavy load can cause instability in driving a tractor. Make sure the tractor is properly counter-balanced with weights. Always drive slowly – especially around turns. An unstable tractor could steer badly and possibly tip over, causing injury or death.

HANDLE BALES SAFELY

- Become familiar with controls.
- Be sure anyone operating the Bale SpinOff is aware of safe operation and potential hazards. Read and observe safety recommendations in this manual.
- Operate power unit from operator's seat only. Remain at controls until operating cycle is complete.
- Do not handle bales that exceed the weight limitations of the power unit or attachment.
- Carry the bale slowly and as low as possible to the ground.
- Operate the hydraulic controls smoothly, avoiding jerky operation.
- When handling round bales on a slope, always approach the bale with the power unit facing uphill.
- Never use the tractor/loader to stop a rolling bale.
- Only use a tractor or power unit equipped with a ROPS cab or roll-over protective structure.
- Use particular care when working on inclines and hill-sides.
- Avoid holes, ditches, and obstructions which may cause tractor/loader to tip.
- Allow for additional length of attachment on tractor while turning.
- Never allow anyone to walk or work under a raised attachment.
- Be sure that people, livestock, or pets are not standing near the machine while operating.

Be sure tractor is properly counter-balanced with weights before attempting to lift any load with the Bale SpinOff Attachment.

If you are handling bales with both the front end loader and the 3 pt. hitch on the tractor, always load the 3 pt. attachment first and unload last.

NOTE: Always make sure bale spear fully penetrates the bale. Partial penetration locates all the weight of the bale on the outer end and can damage spear.

NOTE: In cold weather, a bale frozen to the ground may exceed the lifting capacity of spear and attachment. Damage to spear or attachment may occur. Not covered under warranty. Use tractor to “bump” frozen bales loose from ground.

USING THE SPINOFF AS A BALE MOVER

1. Install the SpinOff on the tractor in accordance with mounting instructions and common three point mounting practices. The hydraulic hoses need not be coupled for moving bales; however, you should keep all hose ends and couplers clean.
2. Back the tractor toward the bale from either end while keeping the center shaft horizontal and near the center of the bale.
3. Continue backing until the center shaft and spinner are fully inserted into the bale.
4. Raise the three point hitch. Attempting to raise the bale with the center shaft and spinner only partially inserted may cause the unit to bend or break.
5. Drive to the desired location, lower the bale to the ground and drive away from the bale.



Power unit must be equipped with ROPS or ROPS cab and seat belt. Keep seat belt securely fastened. Falling off power unit can result in death from being run over or crushed. Keep foldable ROPS systems in “locked up” position at all times.

OWNER SERVICE

TRANSPORTING



When traveling on public roads, whether at night or during the day, use accessory light and devices for adequate warnings to operators of other vehicles. Comply with all federal, state and local laws.

Carry load low.

Check visibility. If visibility is impaired, reduce speed or consider other means of bale transport.

Allow for additional length of spear attachment on tractor while turning.

Select a safe ground travel speed when transporting from one area to another. When traveling on roadways, transport in such a way that faster moving vehicles may pass you safely.

When traveling over rough or hilly terrain or when making turns, slow down and use extra care.

Read all the safety warnings in the front of this manual and in the manual of tractor.

MAINTENANCE

The information in this section is written for operators who possess basic mechanical skills. If you need help, your dealer has trained service technicians available. For your protection, read and follow the safety information in this manual.



NEVER GO UNDERNEATH EQUIPMENT. Never place any part of the body underneath equipment or between moveable parts even when the engine has been turned off. Hydraulic system leak down, hydraulic system failures, mechanical failures, or movement of control levers can cause equipment to drop or rotate unexpectedly and cause severe injury or death.

- Read Manual for service instructions or have service performed by a qualified dealer.



Keep all persons away from operator control area while performing adjustments, service, or maintenance.

Before dismounting power unit or performing any service or maintenance, follow these steps: disengage power to equipment, lower the 3 point hitch and all raised components to the ground, operate valve levers to release any hydraulic pressure, set parking brake, stop engine, remove key, and unfasten seat belt. Never leave equipment unattended with engine running.

Periodically check all bolts to make sure they are tight.

Oil chain every 16 hours of use or every 40 bales fed.

Check hydraulic hoses. Make sure they are not chafed or pinched. Replace any damaged hose.

Keep the chain adjusted to approximately 1/8" to 3/16" deflection.

Keep sprockets in alignment. Check set screws in small sprocket – make sure they are tight.

Check hydraulic hoses and fittings for leaks. Repair any leaks immediately. Never use your hand to check for a hydraulic leak when system is under pressure.

Thoroughly clean the grease zerks before servicing. Dirt mixed with lubricant will rapidly wear parts. Keep it clean.

Grease spinner every 16 hours of use or every 40 bales fed.

Replace any worn or damaged parts immediately. Do not use attachment with any damaged parts.

Replace safety signs and instruction decals if damaged or missing.

STORAGE

- At the end of the working season or when the Bale SpinOff will not be used for a long period, it is good practice to clean off any dirt or grease that may have accumulated.
- Inspect the Bale SpinOff for loose, damaged or worn parts and adjust or replace if needed.
- Always store in a clean, dry location away from children and livestock.
- Storage location should be level and solid to make hitching and unhitching easy.

TROUBLE-SHOOTING GUIDE

PROBLEM	POSSIBLE CAUSE	POSSIBLE REMEDY
Chain or sprocket breakage.	1. Chain too tight.	Adjust motor mount to allow 1/8" to 3/16" chain deflection.
	2. Reversing bale direction too fast.	Allow bale to almost come to complete stop before reversing.
	3. Foreign object caught in chain and sprocket.	Always keep chain guards in place to prevent foreign objects getting caught.
	4. Spinner assembly not lubricated properly.	Lubricate spinner assembly.
	5. Drive chain is rusted from setting outside.	Replace chain and lubricate regularly.
	6. Operator dragging bale on ground while rotating.	Retrain operator – when unrolling frozen bales only bump ground lightly – do not try to rotate bale with constant ground contact.
	7. Operator starting bale rotation with high engine rpm.	Always slow engine rpm almost to idle when engaging hydraulic flow – then raise engine speed after bale is rotating.
	8. Bent spear.	Replace spear.
Chain coming off.	1. Sprockets not properly properly aligned.	Align sprockets with straight edge.
	2. Chain too loose.	Adjust chain.
Bale will not turn.	1. Improper hose connection.	Check remote quick-connect couplers – they may not be properly connected.
	2. Broken chain.	Check chain.
	3. No oil flow.	Valve on tractor is in "off" position. Hydraulic oil flow problems on power unit.

TROUBLE-SHOOTING GUIDE (continued)

PROBLEM	POSSIBLE CAUSE	POSSIBLE REMEDY
Bale comes off spear.	1. Improper toplink adjustment or position.	Rear end of bale should be higher than forward end when operating – adjust toplink.
	2. Operator unrolling when going up hill.	Drive to top of hill and unroll going down.
	3. Bale not completely on spear.	When backing into bale – continue backing until spear and spinner are fully inserted into bale.
	4. Operator having bale contact ground while in forward motion.	Raise 3 pt hitch.
Unrolled hay is too heavy.	1. Bale rotation too fast.	Slow engine rpm and use higher forward gear.
	2. Forward speed too slow.	See above.
Unrolled hay too light.	1. Forward speed too fast.	Use lower gear and increase engine speed.
	2. Bale rotation too slow.	See above.
Bale won't unwind.	1. Twine still on bale.	Remove twine completely.
	2. Bale may be frozen.	Try bouncing bale lightly on ground to loosen. You may have to use the ground to slough the first layer off bale to get it unrolling.
	3. Bale is wrapped very tight.	Check that all twine is removed. Try bouncing the bale lightly on the ground to loosen it.

TROUBLE-SHOOTING GUIDE (continued)

PROBLEM	POSSIBLE CAUSE	POSSIBLE REMEDY
Hydraulic oil overheats.	1. Oil level low.	Check oil level in power unit reservoir.
	2. Dirty filters.	Change oil and filters in power unit per manufacturer's recommendations.
	3. Reservoir of power unit too small.	Allow time for oil to cool down.
Bale rotates too slow.	1. Valve on power unit not adjusted.	Some tractor hydraulic valves have a flow control check valve setting.
	2. Hydraulic system not delivering rated oil volume.	Hydraulic pump may need repair.
	3. Hydraulic system too small.	Find power unit with larger rated hydraulic system.
Hydraulic hose failure.	1. Hose being pinched.	Reroute hose and fasten out of harms way.
	2. Hoses worn or frayed.	Replace hose.
	3. Hydraulic relief pressure on power unit too high.	Adjust relief pressure (if possible) or change power unit.
	4. Hose rating too low.	Replace hose with hose having higher rating.
	5. Operator reversing bale direction with engine at high rpm.	Retrain operator – reverse or stop blade rotation with engine rpm low.

SO-905 PARTS LIST (2.25" Machined Main Spear)

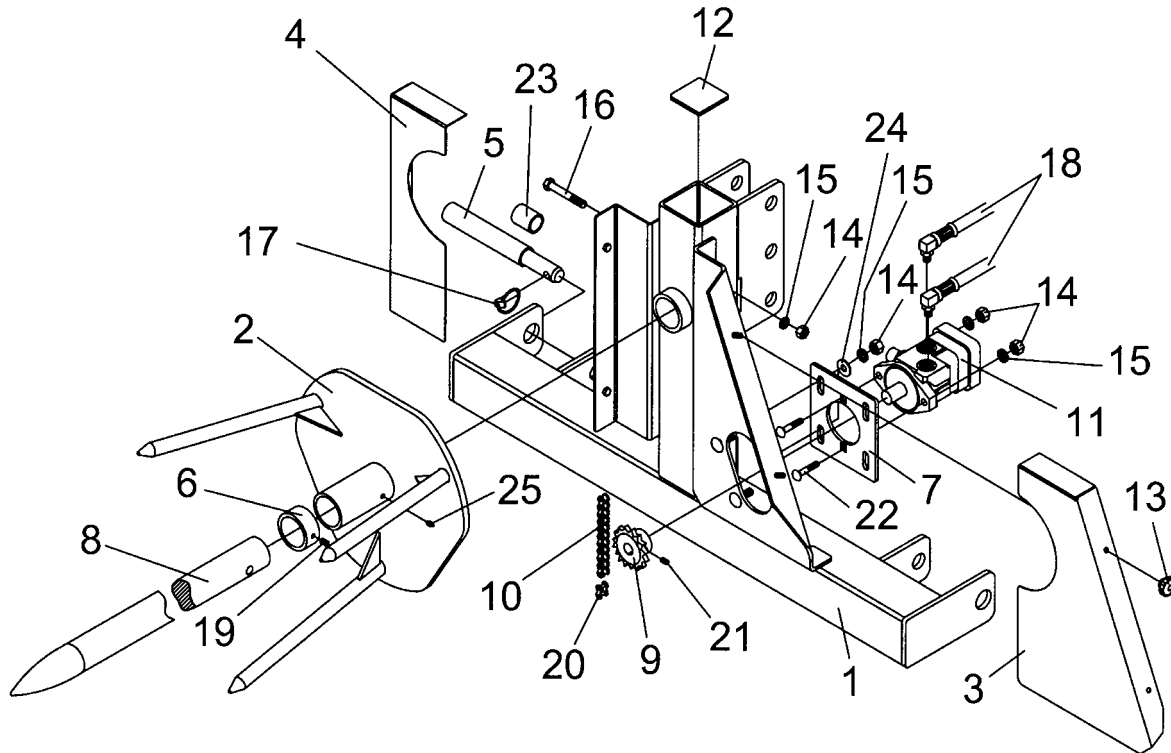

Ref. No.	Part No.	Description	No. Req.
1	830951	Main, Weldment - Spin Off	1
2	830953	Spinner Weldment - Spin Off	1
3	830281	Chain Shield - Spin Off (RH)	1
4	830283	Chain Shield Weldment - Spin Off (LH)	1
5	830290	Hitch Pin - Spin Off	2
6	830942	Collar - Spin Off	1
7	830286	Hydraulic Motor Mount - Spin Off	1
8	830952	Main Spike - Spin Off	1
9	830966	Sprocket - 50B12	1
10	830967	Roller Chain #50 x 43 3/4" (69 Pitches)	1
11	2505640	Hydraulic Motor	1
12	2504300	Plastic Cap	1
13	2504220	Knob - Spin Off	4
14	2500003	Nut, Hex 1/2" - 13NC	7
15	2502002	Washer, 1/2" Spring Lock	7
16	2503313	Bolt 1/2" - 13NC x 5" Hex Head Gr. 5	1
17	590006	Linch Pin 7/16" (AK-14)	2
18	2505633	Hydraulic Hose 1/2" I.D. x 60"	2
19	2503316	Set Screw, Socket 1/2" - 13NC x 1/2"	1
20	480458	Master Link, #50 Chain	1
21	2503057	Set Screw, Socket 5/16" - 18NC x 1/2"	2
22	2503102	Bolt, Carriage 1/2" - 13NC x 1 1/2" Gr. 5	2
23	590126	Lift Arm Bushing - Cat. III to Cat. II (AK-58)	2
24	2501003	Washer, 1/2" Medium Flat	4
25	2504049	Drive Zerk 5/16"	1
N/S	101270	Notice - Grease Zerk	1
N/S	101271	Safety Sign - Danger (Rotating Hay Spike)	1
N/S	101272	Safety Sign - Warning (Moving Chains and Sprocket)	1
N/S	101122	Safety Sign - Warning (High Pressure)	1
N/S	101026	Safety Sign - Warning (Instruction)	1

FSO-906 PARTS LIST

(Forged Main Spear)

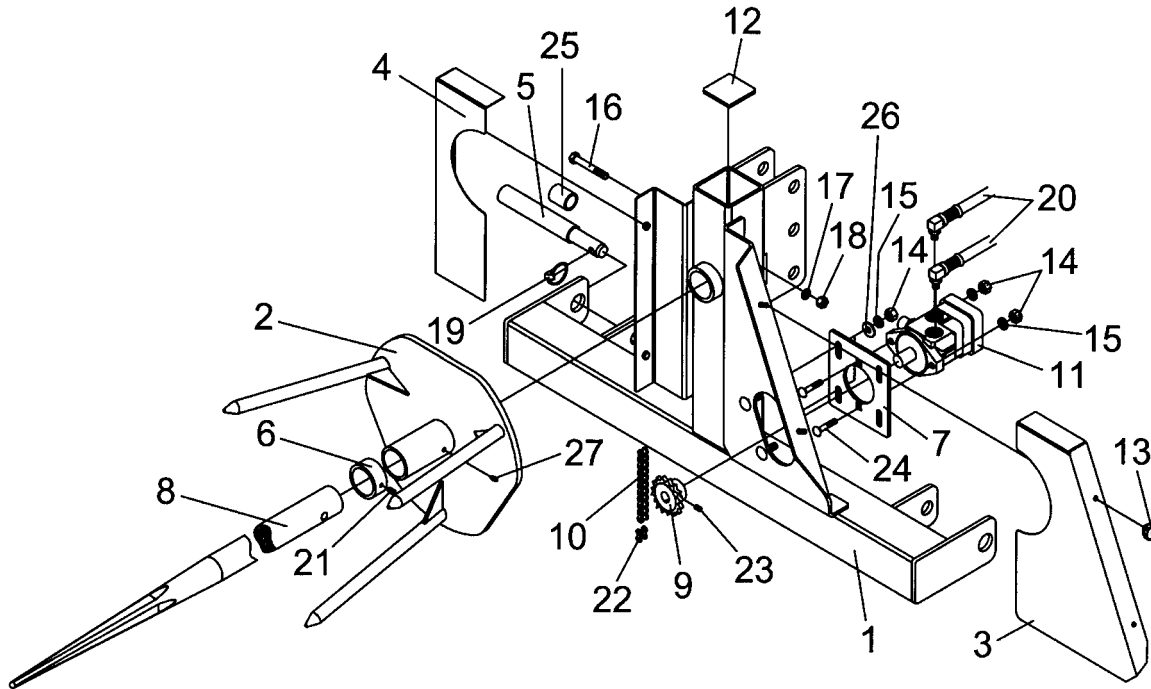

Ref. No.	Part No.	Description	No. Req.
1	831005	Main, Weldment - Spin Off	1
2	831010	Spinner Weldment - Spin Off	1
3	830281	Chain Shield - Spin Off (RH)	1
4	830283	Chain Shield Weldment - Spin Off (LH)	1
5	830290	Hitch Pin - Spin Off	2
6	831004	Collar - Spin Off	1
7	830286	Hydraulic Motor Mount - Spin Off	1
8	831268	Forged Spear - Spin Off	1
9	830966	Sprocket - 50B12	1
10	830967	Roller Chain #50 x 43 3/4" (69 Pitches)	1
11	2505640	Hydraulic Motor	1
12	2504300	Plastic Cap	1
13	2504220	Knob - Spin Off	4
14	2500003	Nut, Hex 1/2" - 13NC	6
15	2502002	Washer, 1/2" Spring Lock	6
16	2503305	Bolt 5/8" - 11NC x 5" Hex Head Gr. 5	1
17	2502007	Washer 5/8" Spring Lock	1
18	2500013	Nut, Hex 5/8" - 11NC	1
19	590006	Linch Pin 7/16" (AK-14)	2
20	2505633	Hydraulic Hose 1/2" I.D. x 60"	2
21	2503316	Set Screw, Socket 1/2" - 13NC x 1/2"	1
22	480458	Master Link, #50 Chain	1
23	2503057	Set Screw, Socket 5/16" - 18NC x 1/2"	2
24	2503102	Bolt, Carriage 1/2" - 13NC x 1 1/2" Gr. 5	2
25	590126	Lift Arm Bushing - Cat. III to Cat. II (AK-58)	2
26	2501003	Washer, 1/2" Medium Flat	4
27	2504049	Drive Zerk 5/16"	1
N/S	101270	Notice - Grease Zerk	1
N/S	101271	Safety Sign - Danger (Rotating Hay Spike)	1
N/S	101272	Safety Sign - Warning (Moving Chains and Sprocket)	1
N/S	101122	Safety Sign - Warning (High Pressure)	1
N/S	101026	Safety Sign - Warning (Instruction)	1

⚠ SAFETY PRECAUTIONS ⚠

**MOST ACCIDENTS OCCUR BECAUSE OF NEGLIGENCE OR CARELESSNESS.
AVOID NEEDLESS ACCIDENTS BY FOLLOWING ALL OF THE SAFETY PRECAUTIONS LISTED BELOW.**

- Machinery should be operated only by those who are responsible and are authorized to do so.
- Stop the engine, lower all equipment, lock the brakes, and remove the ignition key before dismounting from the tractor.
- Never stand between tractor and implement while tractor is being backed to hitch.
- Loose fitting clothing should not be worn, to avoid catching on various parts.
- Detach implement in area where children normally do not play.
- When performing adjustments or maintenance on an implement, first lower it to the ground or block it securely at a workable height.
- Only a qualified operator should be permitted on tractor when in operation; no riders allowed.
- Make certain everyone is in the clear before starting tractor or raising or lowering equipment.
- Operate the tractor and implement only while seated in the driver's seat.
- Reduce speed when transporting mounted implements to avoid bouncing and momentary loss of steering control.
- A heavy load can cause instability of the tractor. Use extreme care during road travel. Slow down on turns and watch out for bumps. Tractor may need front counterweights to counter-balance the weight of the implement.
- Reduce speed on hillsides or curves so there is no danger of tipping.
- Avoid driving too close to the edge of ditches or creeks.
- Do not transport implement on public roads without reflectors and slow moving vehicle emblem in daylight and with approved warning lights at night and other periods of poor visibility.
- Due to the width of some implements, use extra caution on highways, farm roads, and when approaching gates.
- Always be sure the implement is in the proper position for transport.
- Keep alert and watch the front as well as the rear when working with the implement.

OWNER'S/ OPERATOR'S MANUAL

MODEL NO.'s

SO-905

FSO-906

**SINO LEEINGLES, PIDA AYUDA
A AIGUIEN QUE SI LO LEA
PARA QUE LE TRADUZCA LAS
MEDIDAS DE SEGURIDAD.**

JANUARY 2006

RW SPINOFF 3 PT. BALE SPEAR ATTACHMENTS

**WHEN ORDERING REPAIR PARTS,
ALWAYS GIVE THE FOLLOWING INFORMATION:**

1. PART NUMBER
2. PART DESCRIPTION
3. MODEL NUMBER
4. NAME OF ITEM

**MAKE EVERY DAY
A HOLIDAY
FROM ACCIDENTS!**

WORKSAVER, INC.

P.O. BOX 100 LITCHFIELD, IL 62056-0100 (217) 324-5973
WEB: <http://www.worksaver.com> E-MAIL: sales@worksaver.com